

2014 Furniture Catalogue



無印良品

2014 Spring Summer

Storage	6	Storage Furniture	8
		Storage Items	18
		Desk Storage	30
Bedding	35	Bed	36
		Mattress, Bed Pad	42
		Futon, Pillow	43
Sofa	44	Wide Arm Sofa	47
		Living Dining Chair	48
		Unit Sofa	50
		Beads Cushion	52
		Reclining Sofa	53
		Relax Chair	53
Tables & Chairs	54	Wood Furniture	56
		Low Table	57
		Solid Oak Series	58



Pictorial Indicator Used In Catalog



Prefabrication Unit +
Assembly Time (min)



Can be
assembled alone



To be assembled by
two or more persons



Product with optional
parts sold separately



Requires Phillips
Screw Driver

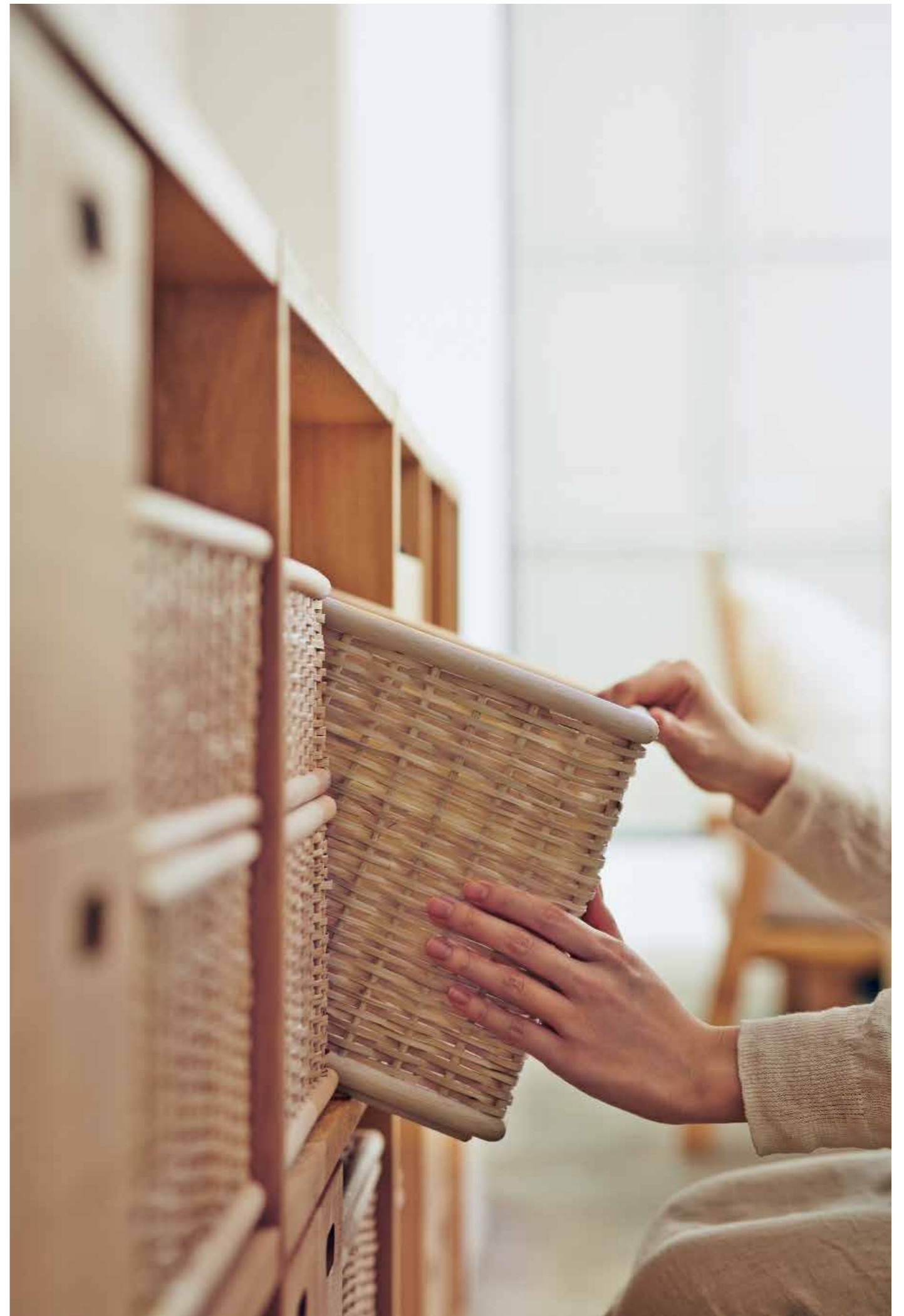
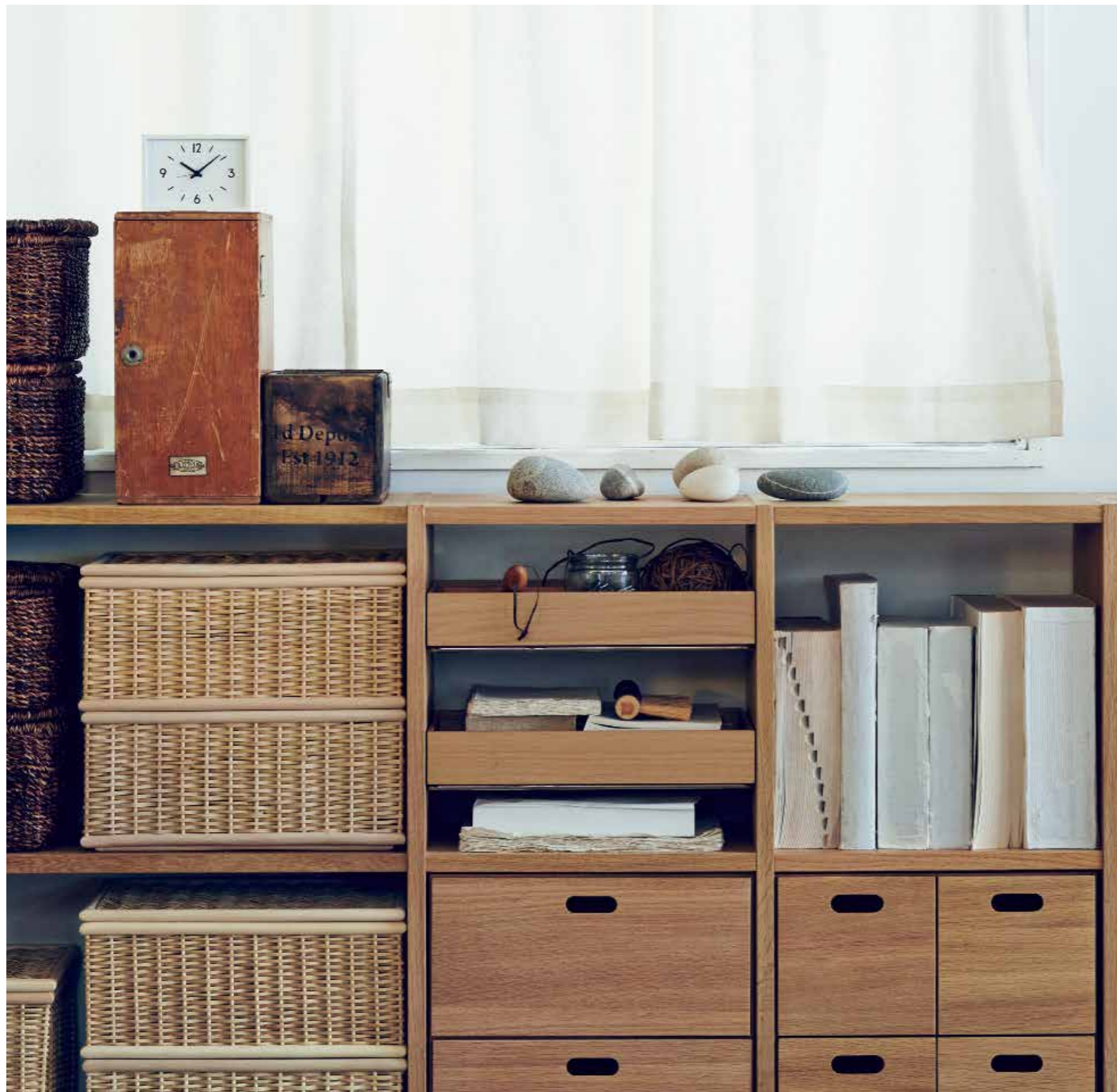



Storage Furniture

Stacking Shelf

A simple storage furniture that allows you to partition the wall flexibly and store your stuff as you desire. This shelf comes in convenient sizes for storage. It also allows compatible storage items in flexible combinations.

Storage

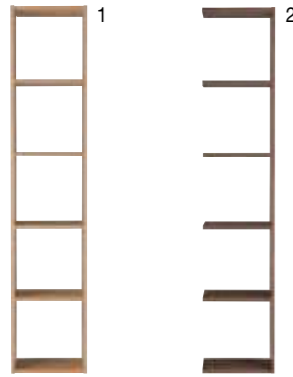

Grid Shelf 5 Row Base

1	18121335	Oak	S\$309.00
	18218615	Walnut	S\$339.00
W42 x D28.5 x H200cm			

Grid Shelf 5 Row Add On

2	18121373	Oak	S\$279.00
	18218646	Walnut	S\$309.00
W40 x D28.5 x H200cm			

Tolerable weight: 20kg per shelf, overall shelf 60kg

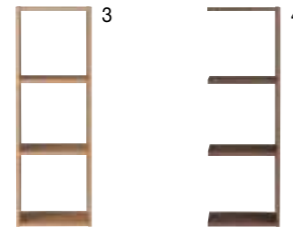

Grid Shelf 3 Row Base

3	18121328	Oak	S\$239.00
	18218608	Walnut	S\$279.00
W42 x D28.5 x H121cm			

Grid Shelf 3 Row Add On

4	18121366	Oak	S\$229.00
	18218639	Walnut	S\$259.00
W40 x D28.5 x H121cm			

Tolerable weight: 20kg per shelf, overall shelf 40kg

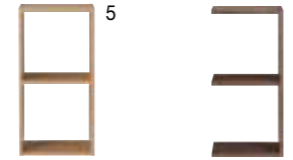

Grid Shelf 2 Row Base

5	18121311	Oak	S\$199.00
	18218592	Walnut	S\$229.00
W42 x D28.5 x H81.5cm			

Grid Shelf 2 Row Add On

6	18121359	Oak	S\$179.00
	18218622	Walnut	S\$209.00
W40 x D28.5 x H81.5cm			

Tolerable weight: 20kg per shelf, overall shelf 30kg

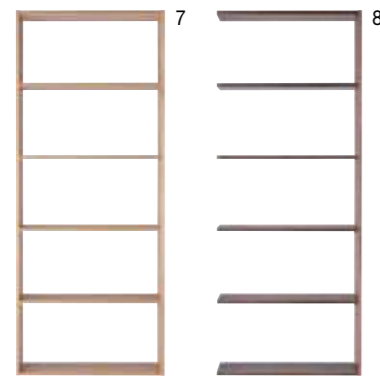

Grid Shelf 5 Wide Base

7	18340057	Oak	S\$399.00
	18340026	Walnut	S\$439.00
W81.5 x D28.5 x H200cm			

Grid Shelf 5 Row Wide Add On

8	18482887	Oak	S\$369.00
	18482870	Walnut	S\$399.00
W79.5 x D28.5 x H200cm			

Tolerable weight: 20kg per shelf, overall shelf 60kg

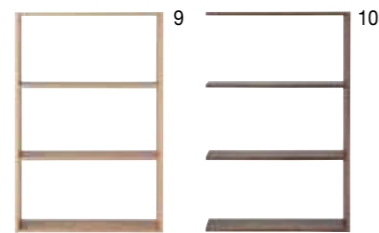

Grid Shelf 3 Wide Base

9	18340040	Oak	S\$329.00
	18340019	Walnut	S\$359.00
W81.5 x D28.5 x H121cm			

Grid Shelf 3 Row Wide Add On

10	18482863	Oak	S\$309.00
	18482856	Walnut	S\$339.00
W79.5 x D28.5 x H121cm			

Tolerable weight: 20kg per shelf, overall shelf 40kg



Grid Shelf 2 Row Wide Base

11	18340033	Oak	S\$279.00
	18340002	Walnut	S\$309.00
W81.5 x D28.5 x H81.5cm			

Grid Shelf 2 Row Add On

12	18482849	Oak	S\$259.00
	18482832	Walnut	S\$289.00
W79.5 x D28.5 x H81.5cm			

Tolerable weight: 20kg per shelf, overall shelf 30kg



Grid Shelf 5R3L Add On

1	18924516	Oak	S\$499.00
	18924530	Walnut	S\$569.00
W120 x D28.5 x H200cm			

Tolerable weight: Top storage area: overall shelf 20kg, centre top board: 40kg



Grid Shelf 5R2L Add On

2	18955183	Oak	S\$399.00
	18955176	Walnut	S\$479.00
W80 x D28.5 x H200cm			

Tolerable weight: Top storage area: overall shelf 20kg, centre top board: 30kg



Grid Shelf 5R3L Add On (T-shape)

3	18924523	Oak	S\$199.00
	18924547	Walnut	S\$229.00
W118 x D28.5 x H40cm			

Tolerable weight: Top board: 40kg



Grid Shelf 5R2L Add On (T-shape)

4	18955206	Oak	S\$129.00
	18955190	Walnut	S\$159.00
W78 x D28.5 x H40cm			

Tolerable weight: Top board: 30kg



| Stacking Shelf Set |

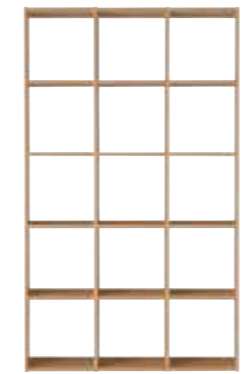

Grid Shelf Set 5R3L

5	61164656	Oak	S\$729.00
	61164663	Walnut	S\$799.00
W122 x D28.5 x H200cm			

Tolerable weight: 20kg per shelf, overall shelf 90kg

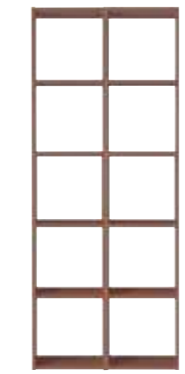

Grid Shelf Set 5R2L

6	61164670	Oak	S\$519.00
	61164687	Walnut	S\$569.00
W82 x D28.5 x H200cm			

Tolerable weight: 20kg per shelf, overall shelf 60kg



Grid Shelf Set 3R3L

7	61164694	Oak	S\$609.00
	61164700	Walnut	S\$699.00
W122 x D28.5 x H121cm			

Tolerable weight: 20kg per shelf, overall shelf 60kg



Grid Shelf Set 3R2L

8	61164717	Oak	S\$399.00
	61164724	Walnut	S\$469.00
W82 x D28.5 x H121cm			

Tolerable weight: 20kg per shelf, overall shelf 40kg



| Stacking Drawers |



Stacking Chest Drawers 2 Tiers

9	18708703	Ash	S\$109.00
	18922222	Walnut	S\$129.00
W37 x D28 x H37cm			



Stackable Chest 4 Tier Shelf

10	61362533	Ash	S\$129.00
	61362540	Walnut	S\$149.00
W37 x D28 x H37cm			



Stacking Chest Drawers 4 Tiers

11	18708710	Ash	S\$129.00
	18922239	Walnut	S\$149.00
W37 x D28 x H37cm			



Tolerable weight: Top board 5kg, 3kg per drawer, overall 5kg

Storage

Structure of Stacking Shelf

You can build your own storage unit just by combining the basic and additional units.

As shown in the drawing below, the units can be easily combined by joining the steel pipes inside the partition plate and then fastening them with bolts.

Stacking Method

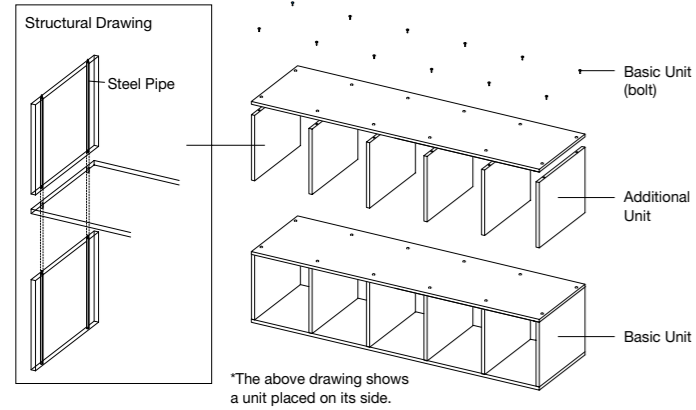

Examples of combinations and load capacity

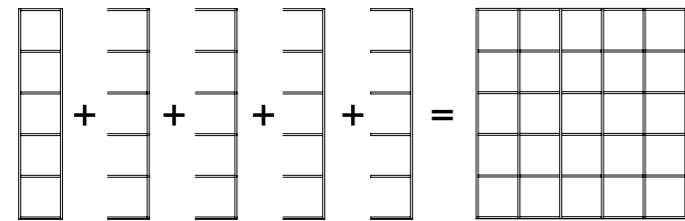

One set of 5-tier basic unit + Four sets of 5-tier additional parts.

This is the combination method to join the units placed upright in a sideways direction.

Load capacity: Total 150kg = 60kg x 5units / 2

For combined unit:
Total load capacity: Load capacity of a unit x number of units / 2

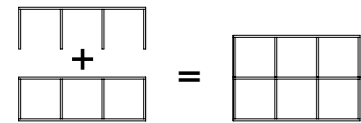

One set of 3x5-tier basic unit + Four sets of 3-tier additional parts.

This is the combination method to join the units placed on their side in an upward direction.

Load capacity: Total 40kg = 40kg x 2units / 2

For combined unit:
Total load capacity: Load capacity of a unit x number of units / 2

Example of Use

Using the unit with partition plates removed and only with steel pipes

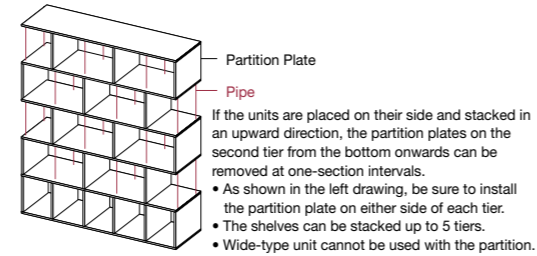
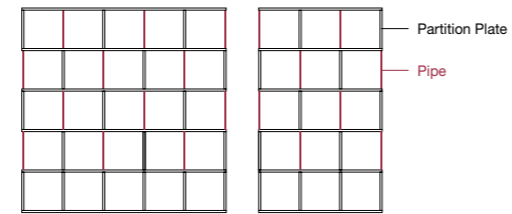

Combining units with different number of tiers

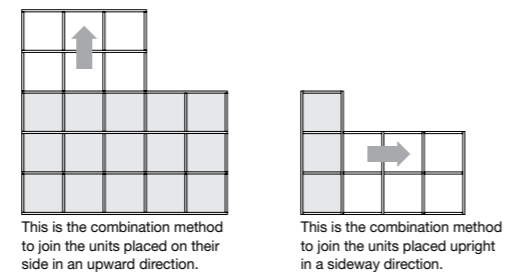

Combining units with different widths

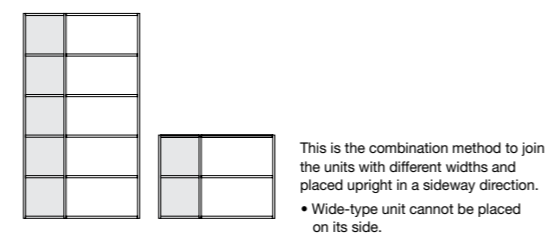

Using the unit as a partition

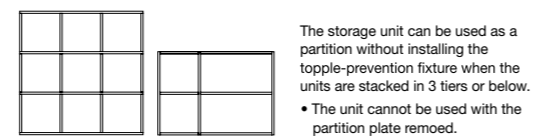

Structure of Open-Type Stacking Shelf

You can build your own storage unit just by combining the basic and open-type parts with steel pipes.

Combination Example 1

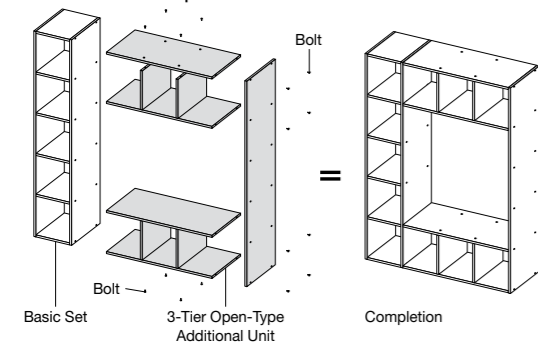

Combination Example 2

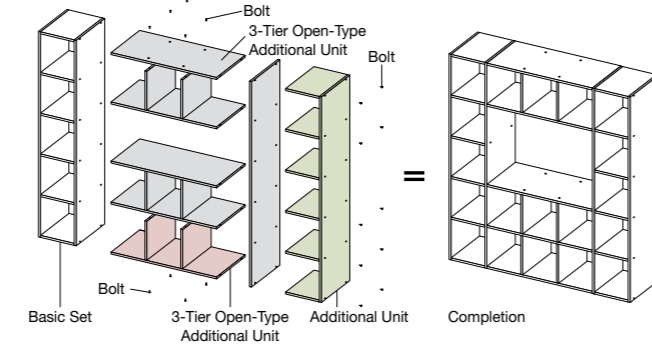



Stacking Cabinets

Build your own storage unit by combining the basic set and additional parts. By combining additional parts, you can make an ideal storage unit or audio visual rack for your living and bedroom.



Stackable Cabinet Set - 162.5cm
 1 [18805983](#) S\$399.00
 W162.5 x D39.5 x H45cm
 Tolerable weight: Top board 65kg, 5kg per shelf

Stackable Cabinet Set Add On - 162.5cm
 2 [18805990](#) S\$359.00
 W162.5 x D39.5 x H40cm



Stackable Cabinet Set - 82.5cm
 3 [15256976](#) S\$239.00
 W82.5 x D39.5 x H45cm
 Tolerable weight: Top board 40kg, 5kg per shelf

Stackable Cabinet Set Add On - 82.5cm
 4 [18805978](#) S\$209.00
 W82.5 x D39.5 x H40cm



Stackable Cabinet High Add On
 5 [18708468](#) S\$569.00
 W162.5 x D39.5 x H79.5cm
 Tolerable weight: Top board 30kg

The high type (additional set) can only be installed on the second stack and 1 stack of the additional set can be added onto it (width 162.5cm type only)



| Additional Parts |



Stacking Cabinet Dividing Board
[18806003](#) S\$33.00
 T2.5 x D37.5 x H37.5cm



Stackable Cabinet Drawer Large
[18806010](#) S\$63.00
 W77.5 x D37.5 x H17.5cm



Stackable Cabinet Glass Door
[18806034](#) Set of 2 pieces S\$49.00
 Glass door type can only be used on the bottom stack. It cannot be used on the second or third stack.



Stackable Cabinet Wooden Door
[18806027](#) Set of 2 pieces S\$63.00

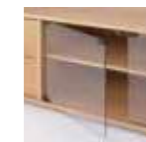

Construction of the stacking cabinet

Stack them up to get the style convenient for you and combine them with the optional parts to get a really handy cabinet.

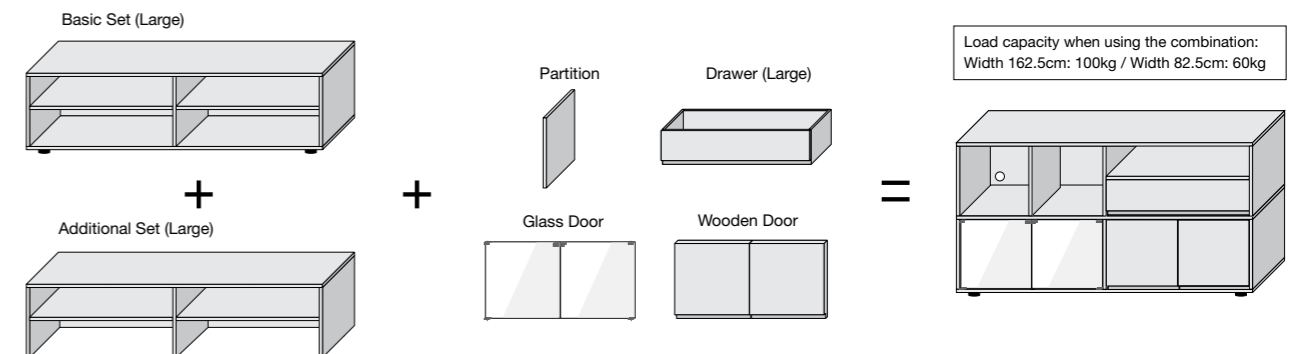

The additional set can be stacked on top of the basic set.

Choose parts you need.

Combine the sets to get a cabinet for your intended purpose.

- Tolerable load when used in combination
 Width: 162.5cm: 100kg in total
 Width: 82.5cm: 60kg in total
- Do not place a TV set whose size protrudes out of the top board.
- Drawers can be fixed up to the third tier.
- For safety reasons, please restrain the use of glass doors at the lowest tier as a precautions against breakages and falling out.

- The sets can be stacked up to 5 tiers. The legs can also be removed. However, a movable rack must be fixed at that location. In addition, the glass or wooden door cannot be used at that location. the back boards at locations using the high type cannot be removed. (Used it when using large AV amplifiers or appliances that generate high heat.)

Wooden Storage

A warm wooden storage that can be easily used in the living room, dining room, kitchen or even bedroom. This series has standardized depth for easy combination with other storage range. Choose and arrange at your will.



Ash Chest 4 Row - 120cm
 [18512089] Natural S\$729.00
 W120 x D40 x H83cm
 Tolerable weight: Top board 30kg, 5kg per drawer



Ash Chest 4 Row - 80cm
 [18121502] Natural S\$469.00
 W80 x D40 x H83cm
 Tolerable weight: Top board 30kg, 5kg per drawer



Ash Chest 6 Row - 80cm
 [18338900] Natural S\$729.00
 W80 x D40 x H119.5cm
 Tolerable weight: Top board 30kg, 5kg per drawer



Ash Cabinet 3 Doors
 [18708628] Natural S\$799.00
 W120 x D40 x H83cm
 Tolerable weight: Top board 30kg, 10kg per shelf



Ash Chest 2 Doors
 [18708611] Natural S\$529.00
 W80 x D40 x H83cm
 Tolerable weight: Top board 30kg, 10kg per shelf



Ash Dresser With Stool
 1 [61845661] Natural S\$399.00
 [61845906] Brown S\$399.00
 W46 x D36.5 x H72cm
 Tolerable weight: Top board 15kg, storage unit 10kg



Side Furniture, Mirror, Coat Stand

These side furnitures are made from wood, aluminium and steel that is easy to match any home furnitures. Also available are coat hangers and mirrors that comes in different size and materials for you to choose from.



Ash Mirror
 1 [18318735] Natural S\$169.00
 [18318742] Brown S\$169.00
 W44 x D33 x H150.5cm



Pinewood Mirror
 [18122868] S\$79.00
 W36 x D50 x H145cm



Aluminium Compact Mirror With Tray
 [15574940] Large S\$43.00
 W20.5 x D18 x H34-44cm
 [15574957] Small S\$33.00
 W17 x D14 x H27cm



Beech Coat Stand
 [61013107] S\$99.00
 W48 x D42 x H173.5cm
 Tolerable weight: 15kg



Ash Coat Hanger
 2 [18499410] Natural S\$159.00
 [18499427] Brown S\$159.00
 W44 x D53.5 x H150.5cm
 Tolerable weight: Shelf 10kg, Hanger 10kg



Steel Tray Stand
 [76580607] S\$59.00
 W45.5 x D34.5 x H51.5cm
 *Wooden Tray sold separately.



Wooden Tray
 [61010502] Ash S\$29.00
 W46 x D35 x H1.5cm



Ash Magazine Rack
 [18491438] Natural S\$39.00
 W36 x D36 x H34.5cm



Ash Dust Box
 [18340170] S\$43.00
 W28.5 x D15.5 x H30.5cm



Ash Dust Box With Lid
 [76856085] S\$49.00
 Dia23.5 x H30cm



Aluminium Dust Box
 [76023739] S\$16.00
 Dia22 x H25cm



Pulp Board Storage

Light and durable storage boxes that can be placed upright or on its side. It is useful as a wall storage furniture, that can join up to 5 units sideways. Available in a wide selection of shapes and sizes.



Pulp Board Box A4 - 5 Rows
 47549201 S\$63.00
 W37.5 x D29 x H180cm
 Fixed shelf tolerable weight: 15kg per shelf, overall shelf 40kg



18121717 Slim S\$56.00
 W25 x D29 x H180cm
 Fixed shelf tolerable weight: 15kg per shelf, overall shelf 40kg

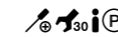

Pulp Board Box A4 - 4 Rows
 18511341 S\$53.00
 W37.5 x D29 x H144cm
 Fixed shelf tolerable weight: 15kg per shelf, overall shelf 35kg



18511358 Slim S\$49.00
 W25 x D29 x H144cm
 Fixed shelf tolerable weight: 15kg per shelf, overall shelf 35kg



Pulp Board Box A4 - 3 Rows
 47549195 S\$43.00
 W37.5 x D29 x H109cm
 Fixed shelf tolerable weight: 15kg per shelf, overall shelf 25kg



18121700 Slim S\$39.00
 W25 x D29 x H109cm
 Fixed shelf tolerable weight: 15kg per shelf, overall shelf 25kg



Pulp Board Box A4 - 2 Rows
 47549188 S\$26.00
 W37.5 x D29 x H73cm
 Fixed shelf tolerable weight: 15kg per shelf, overall shelf 20kg



18121694 Slim S\$23.00
 W25 x D29 x H73cm
 Fixed shelf tolerable weight: 15kg per shelf, overall shelf 20kg



Pulp Board Box Multi-Rack
 18121724 S\$53.00
 W37.5 x D17.5 x H109cm
 Tolerable weight: 8kg per fixed shelf, overall shelf 25kg



Pulp Board Box Free Rack
 18121731 S\$49.00
 W25 x D29 x H109cm
 Tolerable weight: 8kg per fixed shelf, overall shelf 25kg



With both the Multi-Rack and Free Rack being the same size, you can easily combine it side by side for extra storage space.



Storage Items

Polypropylene (PP) Storage Case Series

Our PP Storage Case Series are multifunctional; they are stackable, packable and versatile enough to be utilised for practically anything. Combine different size storage case to match the space requirement and usage.

| PP Clothes Drawer | (W40 x D65cm)



[15112081] Large S\$29.00
 W40 x D65 x H30cm
 Allowed number of stacks: 6 stacks
 Can be fitted with casters (sold separately)



[15112098] Medium S\$23.00
 W40 x D65 x H24cm
 Allowed number of stacks: 7 stacks
 Can be fitted with casters (sold separately)



[15112104] Small S\$19.00
 W40 x D65 x H18cm
 Allowed number of stacks: 8 stacks
 Can be fitted with casters (sold separately)



Tolerable weight: about 7kg (with casters: 3.5kg)

| PP Closet Drawer | (W44 x D55cm)



[15199693] Large S\$29.00
 W44 x D55 x H30cm
 Allowed number of stacks: 6 stacks
 Can be fitted with casters (sold separately)



[15199709] Medium S\$23.00
 W44 x D55 x H24cm
 Allowed number of stacks: 7 stacks
 Can be fitted with casters (sold separately)



[15236640] Small S\$19.00
 W44 x D55 x H18cm
 Allowed number of stacks: 8 stacks
 Can be fitted with casters (sold separately)



Tolerable weight: about 7kg (with casters: 3.5kg)

Semi-transparent boxes - making the best use of polypropylene's natural colour

MUJI made away with the colouring process - a common process to create colourful polypropylene products - to develop these colourless products. Removing the colouring process not only brings the cost down but the semi-transparent result helps in the identification of contents kept in the case while at the same time not showing too much or rather only vaguely showing the contents of the case.

There are 4 series lined up for the large type; these are the "storage case", "clothing case", "closet case" and "wide case". Choose the width, depth and height that suit the size of your cupboard. You can also use the drawer type for dust-proofing or fit in the wheelers to ease transfers of the contents.

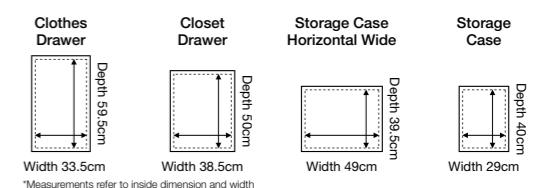

* Please follow the pre-set "allowable number of stacks" and "tolerable weight" to avoid any untoward accidents.
 * Due to the nature of polypropylene, there might be a slight variation in the hardening of the propylene cases. When stacked up, the height of each stack might slightly vary.

PP Storage Case Horizontal Wide | (W55 x D44.5cm)



[18182800] Deep **S\$36.00**
 W55 x D44.5 x H30cm
 Tolerable weight: About 2kg (with casters: about 2.5kg)
 Allowed number of stacks: 6 stacks
 Can be fitted with casters (sold separately)



[47266740] Large **S\$29.00**
 W55 x D44.5 x H24cm
 Tolerable weight: About 3kg (with casters: about 3.0kg)
 Allowed number of stacks: 5 stacks
 Can be fitted with casters (sold separately)



[47266733] Small **S\$23.00**
 W55 x D44.5 x H18cm
 Tolerable weight: About 3kg (with casters: about 3.0kg)
 Allowed number of stacks: 5 stacks
 Can be fitted with casters (sold separately)



A wide storage case that can hold 2 pieces of shirts or sweaters side by side.



[18510269] 4 Tier **S\$99.00**
 W55 x D44.5 x H90cm
 Allowed number of stacks: 5 stacks
 (add on one stack Horizontal Wide case)
 Tolerable weight: About 9kg, 3kg per stack (with wheels on: about 3kg per stack)
 Can be fitted with casters (sold separately)
 The unit cannot be dismantled mid-way of drawers.

[18510252] 3 Tier **S\$73.00**
 W55 x D44.5 x H67.5cm
 Allowed number of stacks: 5 stacks
 (add on two stacks Horizontal Wide case)



Example of Use



With Casters

PP Storage Case | (W34 x D44.5cm)



[15237005] Deep **S\$23.00**
 W34 x D44.5 x H30cm
 Allowed number of stacks: 6 stacks
 Can be fitted with casters (sold separately)



[15527021] Large **S\$19.00**
 W34 x D44.5 x H24cm
 Allowed number of stacks: 7 stacks
 Can be fitted with casters (sold separately)



[15199686] Small **S\$16.00**
 W34 x D44.5 x H18cm
 Allowed number of stacks: 9 stacks
 Can be fitted with casters (sold separately)

Tolerable weight: about 5kg (with casters: 3.0kg)



Combination Examples of Stackable Storage Units

*First 3 sets: Horizontal Wide, next 3 sets: Storage Case

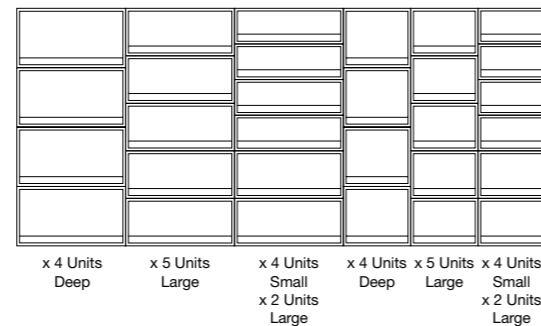

PP Storage Drawer - Deep Type | (W26 x D37cm / Half: W14 x D37cm)



[76749028] 2 Drawers (with partition) **S\$23.00**
 W26 x D37 x H17.5cm
 Tolerable weight (with casters): About 2kg per drawer, 2kg top surface



[76749011] **S\$16.00**
 W26 x D37 x H17.5cm
 Tolerable weight (with casters): About 4kg per drawer, 2kg top surface



Allowed number of stacks: 6 stacks
 Can be fitted with casters (sold separately)



[76749035] Half / 1 Drawer (with partition) **S\$14.90**
 W14 x D37 x H17.5cm
 Tolerable weight (with casters): About 2kg per drawer, 2kg top surface



Allowed number of stacks: 4 stacks
 Can be fitted with casters (sold separately)



Example of Use

PP Storage Drawer - Shallow Type | (W26 x D37cm / Half: W14 x D37cm)



[76749004] 6 Drawers (with partition) **S\$49.00**
 W26 x D37 x H32.5cm
 Tolerable weight (with casters): About 1.5kg per drawer, 2kg top surface



[76748991] 3 Drawers **S\$29.00**
 W26 x D37 x H32.5cm
 Tolerable weight (with casters): About 3kg per drawer, 2kg top surface



Allowed number of stacks: 3 stacks
 Can be fitted with casters (sold separately)



[76748984] 2 Drawers (with partition) **S\$19.00**
 W26 x D37 x H12cm
 Tolerable weight (with casters): About 1.5kg per drawer, 2kg top surface



[76748977] **S\$14.90**
 W26 x D37 x H12cm
 Tolerable weight (with casters): About 3kg per drawer, 2kg top surface



Allowed number of stacks: 10 stacks
 Can be fitted with casters (sold separately)



[76749042] Half / 1 Drawer (with partition) **S\$13.00**
 W14 x D37 x H12cm
 Tolerable weight (with casters): About 1.5kg per drawer, 2kg top surface



Allowed number of stacks: 6 stacks
 Can be fitted with casters (sold separately)

PP Storage Drawer - Thin Type | (W26 x D37cm)



[76749073] 2 Tier **S\$19.00**
 W26 x D37 x H16.5cm
 Allowed number of stacks: 7 stacks



[76749066] **S\$13.00**
 W26 x D37 x H9cm
 Allowed number of stacks: 13 stacks



Can be fitted with casters (sold separately)



Holds CDs

Holds DVDs

Holds A4 Documents

| PP Storage Drawer - Wide Type | (W37 x D26cm)

15253753 Thin **S\$14.90**
 W37 x D26 x H9cm
 Tolerable weight (with casters): About 1kg per drawer,
 5kg top surface (on stacking shelf)
 Allowed number of stacks: 13 stacks
 Can be fitted with casters (sold separately)



15253777 2 Drawers **S\$19.00**
 W37 x D26 x H9cm
 Tolerable weight (with casters): About 0.5kg per drawer,
 5kg top surface (on stacking shelf)
 Allowed number of stacks: 13 stacks
 Can be fitted with casters (sold separately)



15253784 Shallow **S\$16.00**
 W37 x D26 x H12cm
 Tolerable weight (with casters): About 1.5kg per drawer,
 5kg top surface (on stacking shelf)
 Allowed number of stacks: 10 stacks
 Can be fitted with casters (sold separately)



15253791 Deep **S\$17.90**
 W37 x D26 x H17.5cm
 Tolerable weight (with casters): About 2kg per drawer,
 5kg top surface (on stacking shelf)
 Allowed number of stacks: 6 stacks
 Can be fitted with casters (sold separately)



Example of Use

| Additional Parts |



Stopper for PP Storage - Set of 4 pieces
 1 **47554908** Small **S\$5.90**
 2 **47554892** Big **S\$5.90**
 Silicone Rubber



Caster for PP Storage
15523788 Set of 4 pieces **S\$6.30**

Styrol Partition Plate PP Storage
47479584 Large / Set of 4 pieces **S\$16.00**
 W65.5 x D0.2 x H11cm



Examples of Use for Non-Woven Partition Case

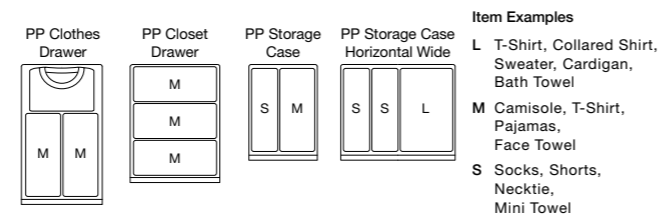

Non-Woven Partition Case - Set of 2 pieces
18182817 Large **S\$9.60**
 W24 x D38 x H12cm
18182824 Medium **S\$7.90**
 W16 x D38 x H12cm
18182831 Small **S\$6.30**
 W12 x D38 x H12cm



| PP Carry Box With Lock |

18723713 Deep **S\$23.00**
 W36 x D52 x H33cm
 Tolerable weight (with casters): About 9kg
 Allowed number of stacks: 5 stacks
 Can be fitted with casters (sold separately)

18723690 Large **S\$19.00**
 W36 x D52 x H16.5cm
 Tolerable weight (with casters): About 7kg
 Allowed number of stacks: 8 stacks
 Can be fitted with casters (sold separately)



61793030 Small / Deep **S\$17.90**
 W25.5 x D37 x H33cm
 Tolerable weight: About 8kg
 Allowed number of stacks: 5 stacks



18723676 Small **S\$14.90**
 W25.5 x D37 x H16.5cm
 Tolerable weight: About 5kg
 Allowed number of stacks: 8 stacks

61793016 Small / Thin **S\$11.00**
 W25.5 x D37 x H8.5cm
 Tolerable weight: About 4kg
 Allowed number of stacks: 14 stacks



| PP Carry Box |

47807493 Deep **S\$19.00**
 W36 x D51 x H33cm
 Tolerable weight (with casters): About 9kg
 Allowed number of stacks: 5 stacks
 Can be fitted with casters (sold separately)

47686692 Large **S\$16.00**
 W36 x D51 x H16.5cm
 Tolerable weight (with casters): About 7kg
 Allowed number of stacks: 8 stacks
 Can be fitted with casters (sold separately)



47686685 Small **S\$11.00**
 W25.5 x D36 x H16.5cm
 Tolerable weight: About 5kg
 Allowed number of stacks: 8 stacks



Example of Use



Example of Use Lock Feature

| PP Carry Box - Foldable Type |

47686715 Large **S\$23.00**
 W36 x D51 x H24.5cm
 Tolerable weight (with casters): About 7kg
 Allowed number of stacks: 8 stacks
 Can be fitted with casters (sold separately)



47686708 Small **S\$16.00**
 W36 x D25.5 x H16.5cm
 Tolerable weight: About 5kg
 Allowed number of stacks: 8 stacks



When Folded



Example of Use



PP Stocker



[15521821] 4 Tier **S\$46.00**
W18 x D40 x H83cm

Allowed number of stacks:
Shallow (15880171): +3 stacks
Medium (47721584): +2 stacks
Deep (15880164): +1 stack



(1) 1xMedium + 2xDeep
[15880188] 3 Tier **S\$49.00**
W18 x D40 x H83cm

Allowed number of stacks:
Shallow (15880171): +3 stacks
Medium (47721584): +2 stacks
Deep (15880164): +1 stack



(2) 2xMedium + 1xDeep + 1xShallow
[15880195] 4 Tier **S\$56.00**
W18 x D40 x H83cm

Allowed number of stacks:
Shallow (15880171): +3 stacks
Medium (47721584): +2 stacks
Deep (15880164): +1 stack



(3) 1xMedium + 3xDeep + 1xShallow
[15880201] 5 Tier **S\$76.00**
W18 x D40 x H122cm



(4) 3xMedium + 1xDeep + 1xShallow
[15880218] 5 Tier **S\$79.00**
W18 x D40 x H122cm



PP Stacker Drawer Add On Parts



[15880164] Deep **S\$19.00**
W18 x D40 x H30.5cm

Allowed number of stacks:
4 stacks



[47721584] Medium **S\$13.00**
W18 x D40 x H21cm

Allowed number of stacks:
5 stacks



[15880171] Shallow **S\$11.00**
W18 x D40 x H11cm

Allowed number of stacks:
10 stacks



PP Wagon With Casters
[15253807] 3 Tiers **S\$29.00**
W29 x D41.5 x H83cm



* Remove the top cover or caster to add on PP stack in the desired combination to create your original design.
* The maximum stacking height is 122 cm.

Note: The units cannot be dismantled mid-way

Combination Examples of Stackable Storage Units

Stackable Storage Unit Guide

	Maximum Estimated Load (with caster fitted on)			Approximate Single Tier Storage Capacity
	Per Tier	Top Surface	Total	
Add On [15880164] Deep Type	±5kg	±3kg	±30kg	1000ml bottles x 4
Add On [47721584] Medium	±5kg	±3kg	±30kg	350ml cans x 4
Add On [15880171] Shallow Type	±2.5kg	±3kg	±30kg	

PP Stacker Size Module

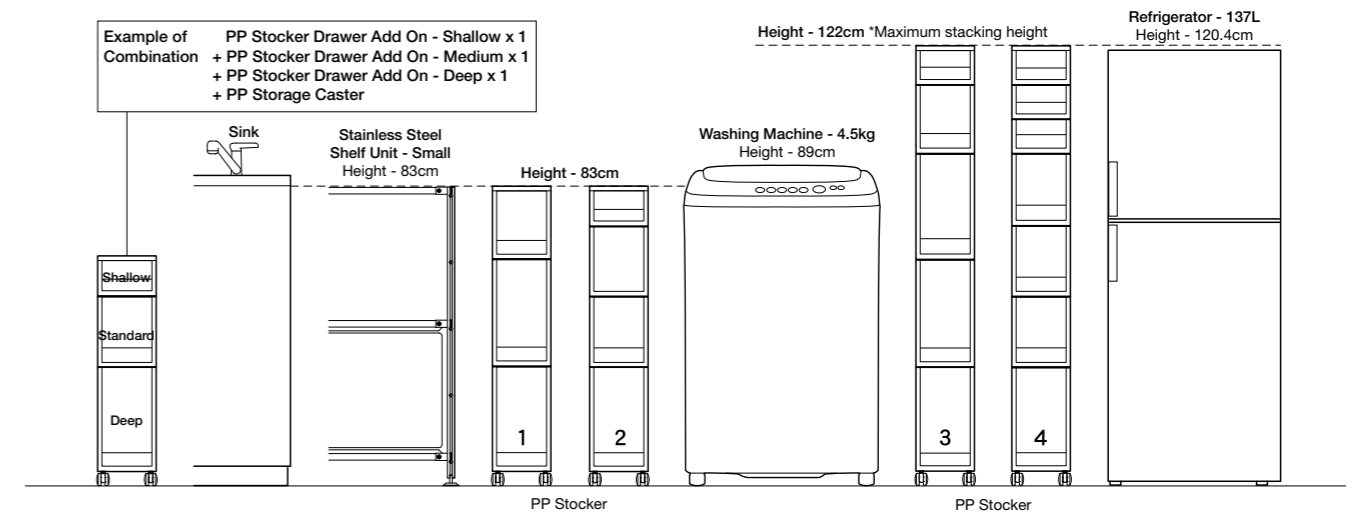
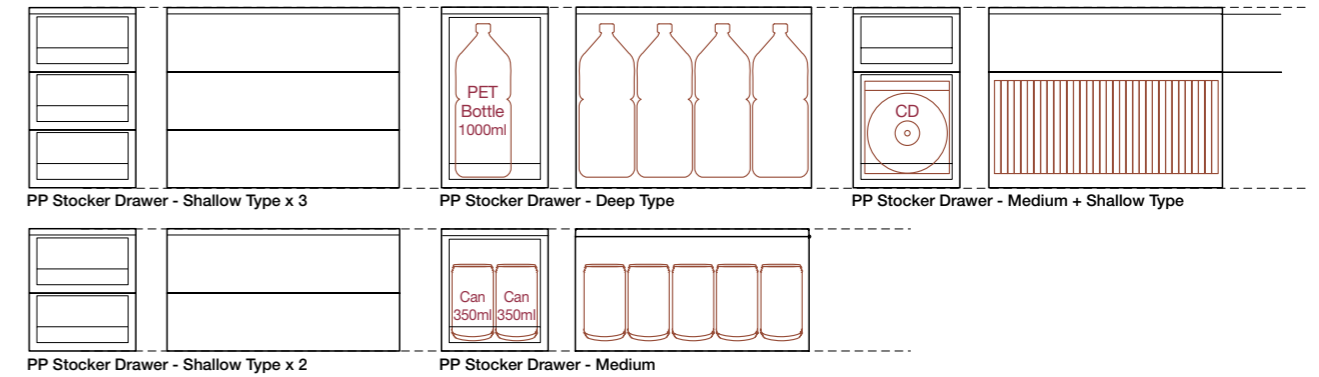



Stackable Storage Basket

Natural-looking hand-woven baskets made from good quality material from the Philippines. These baskets are light, easy to handle and smooth to the touch. These storage baskets comes in standard size for easy storing and stacking.



Bouli Rectangular Basket
47027907 Small S\$16.00
W37 x D26 x H12cm



Bouli Rectangular Basket Lid
18014026 S\$6.90
W37 x D26 x H2cm

*Can be used for S, M, L Basket



Bouli Rectangular Basket
47027914 Medium S\$19.00
W37 x D26 x H16cm



Bouli Rectangular Basket
18014002 Large S\$26.00
W37 x D26 x H24cm



Bouli Rectangular Basket
47027921 Extra Small S\$13.00
W26 x D18.5 x H12cm



Bouli Rectangular Basket Lid
18014033 S\$5.30
W26 x D18.5 x H2cm



Bouli Square Basket
47027938 Medium S\$23.00
W35 x D37 x H16cm

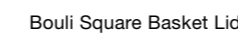

Bouli Square Basket Lid
18014019 S\$9.30
W35 x D37 x H2cm

*Can be used for M, L, XL Basket



Bouli Square Basket
18013999 Large S\$33.00
W35 x D37 x H24cm



Bouli Square Basket
47027945 Extra Large S\$36.00
W35 x D37 x H32cm



Rattan Rectangular Basket
47381290 Small S\$33.00
W36 x D26 x H12cm



Rattan Rectangular Basket Lid
15004768 S\$16.00
W36 x D26 x H3cm



Rattan Rectangular Basket
47381306 Medium S\$39.00
W36 x D26 x H16cm



Rattan Rectangular Basket
47381313 Large S\$49.00
W36 x D26 x H24cm



Rattan Laundry Basket With Lid
47405262 Large S\$79.00
W36 x D26 x H32cm



Rattan Rectangular Box
47381238 Small S\$33.00
W36 x D18 x H12cm



Rattan Rectangular Box With Lid
47381337 S\$36.00
W26 x D18 x H16cm



Rattan Rectangular Box With Handle
47028454 S\$23.00
W15 x D22 x H9cm



Rattan Square Basket
18021833 Medium S\$56.00
W35 x D36 x H18cm



Rattan Square Basket Lid
15004775 S\$19.00
W35 x D36 x H3cm



Rattan Square Basket
18021826 Large S\$79.00
W35 x D36 x H24cm



Cleaning natural storage boxes: Avoid using at humid areas. Take it out under the sun regularly and clean it from dust using a vacuum or a brush.

Bac Bac, Cotton Linen Polyester Soft Box Storage

Bac Bac Storage baskets are made from hand-twisted Apaca rope (Manila hemp). The Cotton Linen Polyester Soft Box can be folded when not in use. These storage items come in standard size for easy storing and stacking.



Bac Bac Rectangular Box With Lid

[76249221] S\$29.00
W26 x D18 x H16cm



Bac Bac Rectangular Basket With Lid

[76249207] Medium S\$46.00
W36 x D26 x H16cm



Bac Bac Square Basket With Lid

[76249214] Extra Large S\$56.00
W36 x D26 x H32cm



Bac Bac Square Basket With Lid

[76249191] Medium S\$49.00
W35 x D35 x H16cm



Bac Bac Square Basket With Lid

[76249184] Extra Large S\$59.00
W35 x D35 x H32cm



Example of Use



Cotton Linen Polyester Soft Box - Half Size

[15003501] Extra Small S\$11.00
W12 x D37 x H12cm



[15003518] Small S\$13.00
W26 x D18.5 x H16cm



When Folded



Example of Use



Cotton Linen Polyester Soft Box - Oblong

[18428847] Small S\$16.00
W37 x D26 x H16cm



[18428861] Medium S\$19.00
W37 x D26 x H26cm



[18428854] Medium With Lid S\$23.00
W37 x D26 x H26cm



[18428762] Large S\$23.00
W37 x D26 x H34cm

*DO NOT WASH



Cotton Linen Polyester Soft Box Square

[15003525] Small S\$19.00
1 [15003532] Small With Lid S\$23.00
W35 x D35 x H16cm



Cotton Linen Polyester Soft Box

[18285044] Large S\$23.00
2 [18285051] Large with Lid S\$33.00
W35 x D35 x H132cm



Cotton Linen Polyester Soft Box - Cloth Case

[18428779] Small S\$33.00
W59 x D39 x H18cm



[15003549] Large S\$36.00
W59 x D39 x H23cm



Storable on Stacking Shelf

Stainless Steel Wire Basket

Wire baskets made from the strong and rust-proof stainless steel. Designed with handles for easy carrying. Can be stacked over one another when the holders are tucked inside the basket.



18-8 Stainless Steel Wire Basket

[15117048] 2 S\$33.00
W37 x D26 x H8cm
Tolerable weight: 5kg
Allowed number of stacks: 2 stacks



[15117055] 3 S\$39.00
W37 x D26 x H12cm
Tolerable weight: 5kg
Allowed number of stacks: 2 stacks



[15117062] 4 S\$43.00
W37 x D26 x H18cm
Tolerable weight: 5kg
Allowed number of stacks: 2 stacks

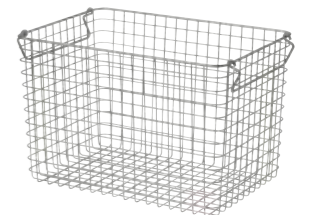

[15117079] 5 S\$49.00
W37 x D26 x H24cm
Tolerable weight: 10kg
Allowed number of stacks: 2 stacks

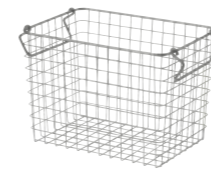

18-8 Stainless Steel Wire Basket

[15117031] 1 S\$29.00
W26 x D18 x H18cm
Tolerable weight: 5kg
Allowed number of stacks: 2 stacks

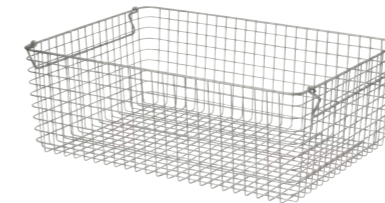

[15117147] 6 S\$63.00
W51 x D37 x H18cm
Tolerable weight: 10kg
Allowed number of stacks: 2 stacks



Holds A4 Documents



Acrylic Storage

Acrylic Storage Series allows easy identification of the contents stored. It is scratch resistant to maintain the beauty of the material. Available in a wide variety of shapes and sizes that fits your desk or even bathroom sink.



Acrylic Stand for Letter

76226291
W5 x D13 x H14.1cm

A desktop stand convenient for storing envelopes and postcards.



Acrylic Cosmetic Stand

61155364
W12.7 x D17 x H9.5cm

Removable dividers allow you to store loose stationery and cosmetic items. Made in standard size for easy combination with other acrylic storage items.



Acrylic Memo Pad Holder

61155371
W12.7 x D17 x H4.7cm

Stackable with other similar sized acrylic storage items.
*Velour inner box dividers cannot be used for this product.



Acrylic Stand - Deep

61407876
W17.5 x D13 x H9.5cm

Stackable drawer-type acrylic case. Convenient for storing small cosmetic items and toiletries.



Acrylic Case With Drawer - 2 Rows

47380910
W17.5 x D13 x H9.5cm

47380934 Large
W25.5 x D17 x H9.5cm
Stackable with other similar sized acrylic storage items.



Acrylic Case With Drawer - 2 Rows

47380965
W17.5 x D13 x H9.5cm

47380989 Large
W25.5 x D17 x H9.5cm
Stackable with other similar sized acrylic storage items.



Velour Inner Case - Longitudinal

47381009
W16 x D12 x H2.5cm

Inner box for storing accessories and watches in the Acrylic Case With Drawer.
*Two can be fitted into the large drawer.



Velour Inner Case - 15 Partitions

47266825
W16 x D12 x H2.5cm

Inner box for storing jewellery in the Acrylic Case With Drawer.
*Two can be fitted into the large drawer.



Velour Inner Case - 6 Partitions

47266887
W24 x D16 x H2.5cm

Inner box for storing accessories and watches in the Acrylic Case With Drawer.
*One can be fitted into the large drawer.



Velour Inner Case - Ring

47266870
W24 x D16 x H2.5cm

Inner box for storing jewellery in the Acrylic Case With Drawer.
*One can be fitted into the large drawer.



Acrylic Glasses Stand

61174280
W6.7 x D17.5 x H25cm

Holds glasses and small items in four drawers. This storage item can be used upright or sideways.



Velour Inner Case

61155036
W5 x D16.5 x H2.5cm

*Exclusively for Acrylic Glasses Stand.



Velour Earrings & Necklace Stand

18958207
W6.7 x D13 x H25cm

Perfect for hanging earrings and necklace. Transparent storage stand for easy identification of the contents stored.



Velour Inner Case

61155388
W5 x D12 x H2.5cm

Inner box for storing rings.
*Exclusively for Acrylic Earrings & Necklace Stand.





Acrylic Storage Stand

61798233 A5 S\$23.00
Perfect for organizing the things on your desk. Suitable for storing A5 documents, notebooks and catalogues.



Acrylic Box 3 Drawers

76475958 A4 S\$49.00
Can be used upright or sideways by changing the arrangement of inner plates.



Acrylic Case

61485546 3 Rows S\$23.00
W26 x D17.5 x H10cm
15873128 5 Rows S\$39.00
W26 x D17.5 x H16cm



Acrylic Box - 3 Drawers

18076697 S\$26.00
W13 x D8.8 x H14cm



Acrylic Single Drawer Unit

61798196 S\$29.00
W25.2 x D17 x H8.7cm
Perfect for holding tiny miscellaneous items. Finished with high transparency acrylic material for easy identification of the contents stored.



Acrylic 3 Drawer Unit

61798202 S\$39.00
W8.7 x D17 x H25.2cm
Finished with high transparency acrylic material for easy identification of the contents stored. Combine with other acrylic storage items for extra storage space.



Acrylic Pen Stand

61479798 S\$2.90
W5.5 x D4.5 x H9cm



Acrylic Pot

61479781 Small S\$4.90
Dia8 x H11cm
61485584 With Lid S\$5.90
Dia8 x H11.5cm



Acrylic Tissue Box

76226284 S\$12.90
W26 x D13 x H7cm



Acrylic Stand with Partition - Half

61407869 Small S\$9.90
W17.5 x D6.5 x H4.8cm
61407852 Large S\$13.90
W17.5 x D6.5 x H9.5cm
Stackable acrylic case perfect for storing small cosmetic items and toiletries.



Acrylic Stand with Partition - Clear

61407838 S\$19.00
W17.5 x D13 x H9.5cm
Stackable with other similar sized acrylic storage items.



Acrylic Stand with Partition - Half

61407845 Large S\$29.00
W25.8 x D17.5 x H6.1cm
Stackable acrylic case perfect for storing small cosmetic items and toiletries. Internal dividers can be removed to create more storage space.



Acrylic Pen Stand

61238647 Small S\$11.90
W8.8 x D8.8 x H9.5cm
61238654 Large S\$16.00
W13 x D8.8 x H9.5cm



Acrylic Rack

61238661 Small S\$19.00
W8.8 x D13 x H14.2cm
61238678 Large S\$29.00
W17.5 x D13 x H14.2cm



Acrylic Partition Shelf

76226239 Small S\$10.90
W26 x D17.5 x H10cm
76226246 Large S\$13.90
W26 x D17.5 x H16cm



Acrylic Collect Box

61703671 4x4 S\$49.00
W27.5 x D7.2 x H34.7cm
Uses non-transparent rear panel for better presentation of items.
Contents can be taken in and out from both front and back.



Acrylic CD Stack Rack

76226277 S\$23.00
W13.5 x D27 x H15.5cm
Stackable CD rack. Holds about 25 CDs.



Acrylic CD Rack - Box Type

76226253 S\$19.00
W17.5 x D13 x H14cm
Stackable CD box. Holds about 16 CDs.



Acrylic DVD Rack - Box Type

76226260 S\$29.00
W17.5 x D13 x H21cm
Stackable DVD box. Holds about 11 DVDs.

| MDF Small Storage |

MDF accessory storage finished in size perfect for storing the items on your desk.



MDF Drawer

76617969 6 Tier S\$59.00
W8.4 x D17 x H25.2cm
76617952 3 Tier S\$49.00
W8.4 x D17 x H25.2cm

MDF, Sliced ash wood veneer, Lacquer-finished
Finished with an ash wood surface, easy to match interior décor. Usable both upright and sideways by changing the arrangement of drawers.



MDF Single Drawer Unit

76617945 S\$39.00
W25.2 x D17 x H8.4cm
A size perfect for organizing the things on your desk. Comes with one piece of inner divider for partitioning.



MDF Storage Stand

61798066 A5 S\$26.00
W8.4 x D17 x H25.2cm
MDF, Sliced ash wood veneer, Lacquer-finished
Finished with an ash wood surface, easy to match interior décor. A size perfect for organizing the things on your desk.

Study Desk System Type

Make your own desk by combining your choice of top board and legs. Simple yet durable, this product can be used for various applications. Optional parts are available for your customization.



Desk Top Panel - Ash
 61394572 S\$229.00
 W150 x D60 x Thk2cm
 61394565 S\$199.00
 W120 x D60 x Thk2cm



Desk Top Panel - Melamine White
 61394541 S\$229.00
 W150 x D60 x Thk2cm
 61394534 S\$199.00
 W120 x D60 x Thk2cm



Desk Steel Legs
 18121199 S\$139.00
 W150 x D60 x H72cm
 18121182 S\$119.00
 W120 x D60 x H72cm

| Optional Parts |



Steel Cabinet - Light Grey
 18121236 S\$339.00
 W39.5 x D56 x H62.5cm
 10 i P



Designed with rounded corners for safety with the intention of minimizing the pain if you hit against it.

The back board of the top and middle drawers are made higher to prevent things kept in the drawers from falling.

The bottom drawer is designed to be able to be pulled out to the end of its back board.



Working Chair
 18121298 Light Grey S\$209.00
 18121304 Black S\$209.00
 W55.5 x D73 x H74~84cm (Seat Height 39~49cm)
 20 i



When the arm is attached

Working Chair Arm Set of 2
 18121861 Light Grey S\$49.00
 18121878 Black S\$49.00
 When mounted: W57 x D53 x H74~84cm
 10 i



More Backward Arm Position
 Arms were positioned more backward for easy elbow resting during relax time.



Lower Seat Height
 Seat height is made lower for the users that are small in size and users who do not wear shoes in the room.



Sophisticated Rear View
 Bolts on the back rest are made invisible for a more sophisticated appearance.



Round Finished Legs
 Legs are finished with a roundish shape to avoid hurting the bare foot of the user.



Bedding



Storage Bed

A bed with an under-bed storage equivalent to the storage of 2 units of 4-tier wide chest drawers. Suitable to store everyday clothing or even larger items such as suitcases or futon mattresses.



Additional Box
With wooden spring base removed.
*There is no base board under the open space as shown.

[Storage Area] Double Bed

4 Tier Wide Chest with storage power of 2 combined units.

For a more effective storage in rooms, we have relooked into under-bed storage designs. Using storage box itself to support the mattress, more storage space is now available.



*Combination example: Mattress is sold separately.

Storage Bed - Oak

[15056705] / [15057016] Single	S\$459.00
W105.5 x D201 x H27cm	
[15056729] / [15057016] Double	S\$619.00
W148.5 x D201 x H27cm	



Storage Bed - Walnut

[15056989] / [15057023] Single	S\$539.00
W105.5 x D201 x H27cm	
[15057009] / [15057023] Double	S\$699.00
W148.5 x D201 x H27cm	



Storage Bed Additional Box - Oak

[76359920] Single	S\$96.00
W105.5 x D15 x H27cm	
[76359944] Double	S\$129.00
W148.5 x D15 x H27cm	



Storage Bed Additional Box - Walnut

[76359951] Single	S\$109.00
W105.5 x D15 x H27cm	
[76359975] Double	S\$149.00
W148.5 x D15 x H27cm	





Wooden Bed Frame

A simple bed with a thin frame that makes the room look bigger. You can add a headboard or storage baskets under the bed according to your preference.



Choose your own bed base

There are many features we want to have for our bed simply because we spend a lot of time on it. Some of us want to have 2 single beds side-by-side or beds with spacious storage; beds with a more rounded design or beds with good ventilation. The list is endless.

This MUJI wooden bed is a bed designed in answer to these desires. The wooden springs of this bed come with belts to adjust the bedstead to the desired hardness or softness. The headboard and the wooden under-bed storage drawers have also been designed for effective space usage when 2 single beds are joined side-by-side.

MUJI's aim is to create a bed that is comfortable to sleep on and practical in daily living.

1. Headboard

The reclined headboard has been designed for a more relaxing posture when leaned against while doing some reading or writing before bedtime – the other way to enjoy this bed.

2. Wooden Springs

The wooden springs are given some sort of flexibility too. This doubles the effect of the mattress, minimizing the body weight distribution to the back and hip.

3. Base Legs

The base legs can be dismantled for those who prefer to have their bed frame lie flat on the floor instead.

4. Storage

The spacious wooden under-bed storage drawers can be a great tool to effectively use the space under the bed. These wooden storage drawers can be used to keep large fabrics such as blankets or compartmentalized to keep frequently used smaller items.

5. Mattress

Choose from the 3 types of mattresses available that suit your preferences.



*Combination example: Mattress is sold separately.



*Combination example: Mattress is sold separately.

Wooden Bed Frame

1	[61331065] Natural / Single	S\$419.00
	W103 x D202 x H25.5cm	
	[61331089] Natural / Double	S\$599.00
	W147 x D202 x H25.5cm	
3	[61331102] Brown / Single	S\$419.00
	W103 x D202 x H25.5cm	
	[61331171] Brown / Double	S\$599.00
	W147 x D202 x H25.5cm	



Wooden Bed Headboard

2	[61199412] Natural / Single	S\$169.00
	W103 x D8 x H53cm	
	[61194844] Natural / Double	S\$239.00
	W147 x D8 x H53cm	
3	[61194851] Brown / Single	S\$169.00
	W103 x D8 x H53cm	
	[61194875] Brown / Double	S\$239.00
	W147 x D8 x H53cm	



Wooden Bed Storage Box - Large

4	[61049045] Natural	S\$189.00
	[61133676] Brown	S\$189.00
	W80 x D90.5 x H19cm	



Wooden Bed Storage Box

5	[61049038] Natural	S\$159.00
	[61133669] Brown	S\$159.00
	W80 x D60.5 x H19cm	



Pocket For Wooden Bed

6	[61048970]	S\$33.00
	W29 x H26.5cm	



| Bonnel Coil Mattress |



Simple Classic Bed

The mattress focuses on the inner layer materials such as spring coils. Bed pads are washable to maintain cleanliness. Available in various types.



Bonnel Coil Mattress With Legs

[61033716] Single	S\$209.00
W98 x D198 x H38/46cm	



Legs For Mattress - Natural

[47462203] H20cm	S\$33.00
[15296972] H26cm	S\$39.00

*Height 26cm is for Single size only.

Replaceable side fabric and spring unit

The support legs, wooden frame and spring unit can be separated and covered completely with the side fabric attached with a detachable tape. Parts are also sold individually so replaceable parts can be replaced accordingly. Disposing of parts are also more environmental friendly as parts for disposal can be sorted out to its type.



Mattress rotation made possible

Rotate the side of the head and legs regularly every season. If weight is concentrated on one side of the coils all the time, the strength of it on that side will reduce. If the mattress is rotated regularly, it will remove such weight and pressure will be released of the coils. Also, try to stand and air the mattress regularly. Leaving it down all the time will cause humidity retention and become the hotbed for moulds.

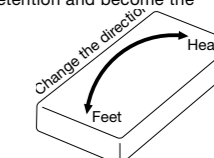

Mattress, Bed Pad

The use of urethane foam is minimized as much as possible so that a comfortable sleep induced from the use of spring coils can be maximized. Add on a washable bed pad to maintain cleanliness.



More spring coils, higher stability for a good sleep posture.

Increasing the number of coils disperses the body pressures. It also suppresses the load to the backbone and hip. As coils move in synchrony with the unevenness of the body, the coils can support the body in good balance and maintain a longer stable body posture.

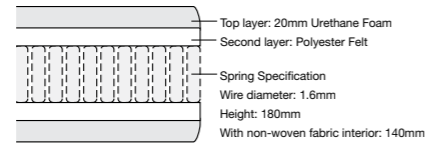

High Density Pocket Coil Mattress

[15783724] Single	S\$899.00
W97 x D195 x H19cm	
[15783748] Double	S\$1299.00
W140 x D195 x H19cm	
[15783755] Queen	S\$1599.00
W160 x D195 x H19cm	



Stand-alone coils provide point-support to the body.

The many stand-alone coils are closely positioned to one another to create a mechanism that absorbs the body weight on each of its point. This links to a balanced support to the entire body. It maintains a stable posture of the body and prevents the wobbling or indents on the mattress.

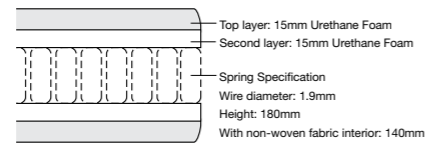

Pocket Coil Mattress

[18094844] Single	S\$499.00
W97 x D195 x H19cm	
[18094868] Double	S\$899.00
W140 x D195 x H19cm	
[61863351] Queen	S\$1099.00
W160 x D195 x H19cm	



The high resilience provides a steady support to the body.

Drum-shaped coils are joined together so that the entire mattress surface firmly supports the body pressure. This product uses Bonnel coil springs which are currently the most popular and reliable with proven performance and excellent resiliency.

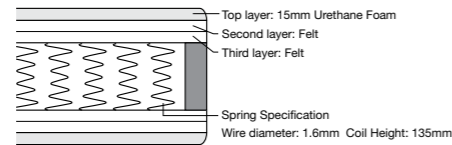

Spring Mattress

[18510610] Single	S\$239.00
W97 x D195 x H18cm	
[18510634] Double	S\$399.00
W140 x D195 x H18cm	



Bed Pad With Elastic Rubber	
[18988877] Queen	S\$139.00
W160 x L200cm	
Fabric: 50% Cotton, 50% Polyester	
Filling: 100% Wool	



Antibacterial Washable Bed Pad With Elastic Rubber	
[18557325] Single	S\$49.00
W100 x L200cm	
[18557349] Double	S\$69.00
W140 x D195 x H18cm	
Fabric: 55% Cotton, 45% Polyester	
Filling: 50% Cotton, 50% Polyester	



Example of Use

Futon, Pillow

For sleeping comfort, our bedding has been developed to focus on materiality and functionality. Select your ideal bedding from our wide range of variety.



Body Pressure Dispersion Futon

[15000739] Single	S\$399.00
W100 x L200cm	
Fabric: Front - 65% Polyester, 35% Cotton; Back - 100% Polyester	
Padding: Urethane Foam	
*Do not wash	



Antibacterial Washable Futon

[61170398] Single	S\$269.00
W100 x L210cm	
Fabric: Front - 65% Polyester, 35% Cotton; Back - 100% Polyester	
Padding: Polyester Mattress	



Polyester Hard Mattress For Futon

[18387403] Single	S\$93.00
W95 x D210 x H4cm	
Fabric: 50% Polyester, 50% Cotton	
Filling: 100% Polyester	
*Do not wash	



Wool Polyester Hard Futon

[18988815] Single	S\$119.00
W100 x L210cm	
Fabric: 100% Cotton	
Filling: 50% Wool, 50% Polyester	
Solid Cotton: 100% Polyester	



Feather Pillow

[18810529]	S\$16.00
43 x 63cm	
[18810536]	S\$19.00
50 x 70cm	
Made with lightweight feathers, the pillow feels soft and does not sink easily providing comfort for a good sleep.	



Urethane Foam Low Repulsion Pillow

[15001910]	S\$33.00
43 x 63cm	
This pillow is made from low and high repulsion urethane which provides extreme comfort on your neck and head.	

*Regularly let the mattress stand off the floor to ventilate it. Leaving the mattress over a long period on the floor may cause the formation of moulds.

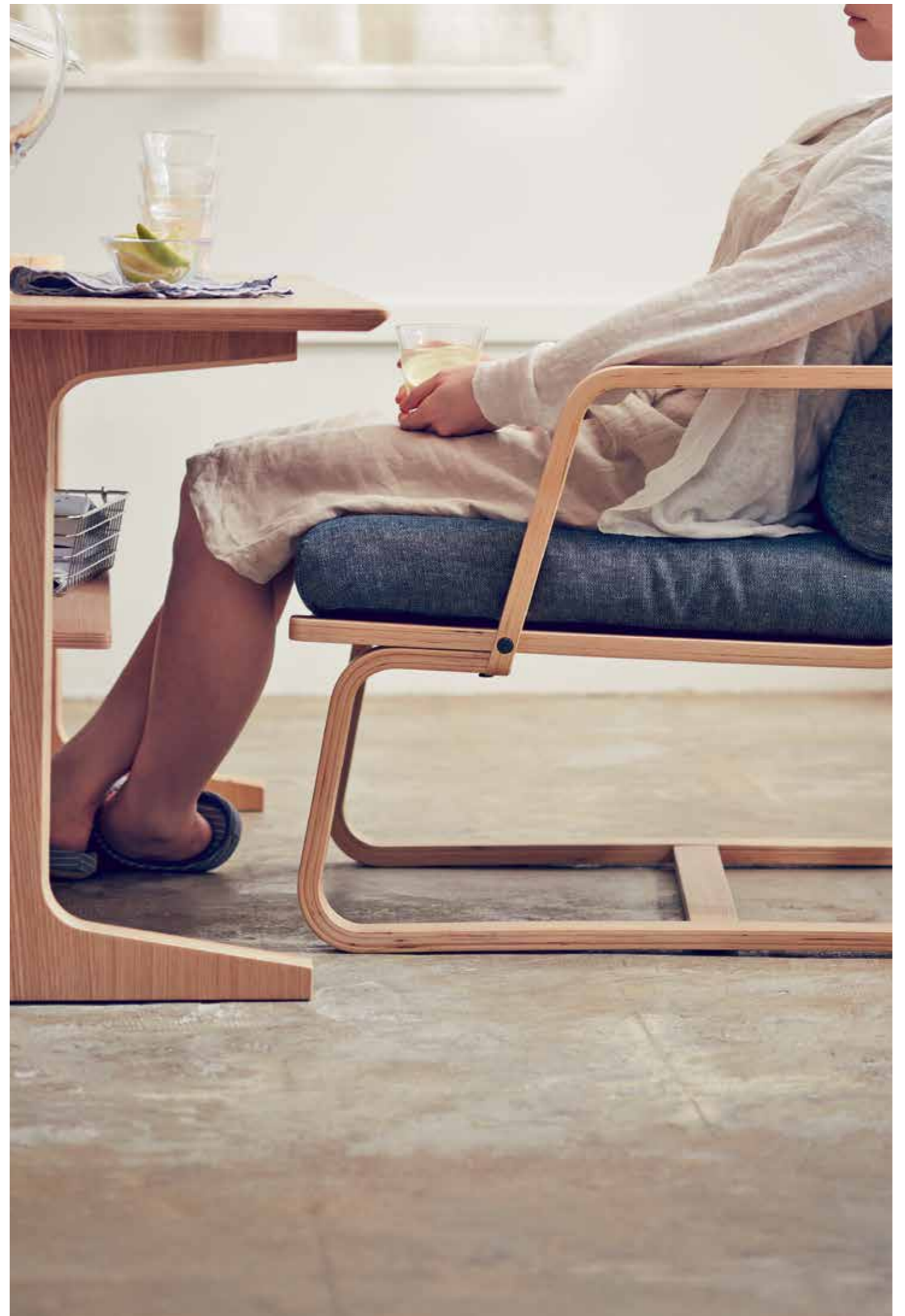



Sofa

Wide Arm Sofa

Comfort at its own. Choose the cushion type, the colour of the legs and the combination of the cover that matches your home.

| Feather Pocket Coil Cushion |

The sofa is a coupled-effect of the soft feather cushioning and the assuring stability of the pocket coils.



Sofa Body - 2.5 Seater
 [47276992] S\$899.00
 W190 x D87.5 x H75cm
 (P)

The feather and pocket coil combination sofa sort of wraps one's body when sat on. The back rest has a soft feather cushiony feel while the sofa seat itself has a sturdy and soft coil-feather feel. A design made for relaxation.

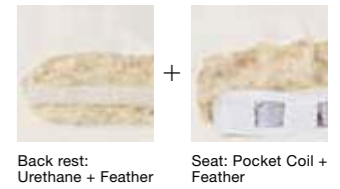

| Urethane Foam Cushion |

A slightly sturdy sofa that eases the movement of getting up and seating. The cushion softens up to the body after frequent use.



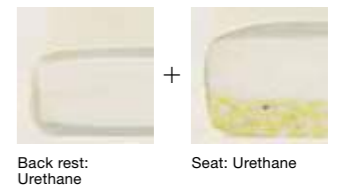

Sofa Body - 2.5 Seater
 [47276985] S\$699.00
 W190 x D87.5 x H75cm
 (P)

A combination of a very sturdy seat and urethane cushion, this sofa uses a just-right urethane hardness to create the needed stability for seating. The sturdy urethane back rest and seat is not too soft which provides a great support to the body.



Ottoman
 [47276916] S\$129.00
 W54.5 x D35 x H35cm
 (P)

| Additional Parts |

Legs for Sofa / Ottoman			
	1 [47277029] Natural		S\$33.00
	2 [47277036] Brown H10cm		S\$33.00

*All covers sold separately. Kindly refer to page 51 for cover selection.



Living Dining Table & Chair

Embracing the unity of the two spaces catering to relaxation, dining or both. With the right furniture, a living and dining area can live beautifully within the same walls.



Living Dining Table 1

15253845
W150 x D65 x H60cm

S\$649.00



Living Dining Table 2

15253852
W130 x D65 x H60cm

S\$569.00



*Only for Special Order.



Arm Sample

Living Dining Sofa Chair

15253722
W55 x D78 x H77cm

S\$399.00



Living Dining Sofa Chair Arm Set

15253739
Set of 2 pieces

S\$49.00



Example of Use

Living Dining Sofa Chair Connecting Plate

15549597
Set of 2 pieces

S\$16.00



Living Dining Bench 1 [August]

15257058
W115 x D46 x H40.5cm

S\$399.00



Living Dining Bench 2

15257065
W58 x D46 x H40.5cm

S\$239.00



*All covers sold separately. Kindly refer to page 51 for cover selection.

Unit Sofa

MUJI Unit Sofa Series is now available in two sizes. Freely arrange the unit sofas in a position that suits your living space and lifestyle. Made with urethane foam, this sofa range assures good seating comfort.



With Armrest [August]

[15815159](#) Large S\$489.00

W95 x D82 x H66cm

[15815180](#) Small S\$399.00

W82 x D82 x H66cm



Armless [August]

[15815166](#) Large S\$399.00

W74 x D82 x H66cm

[15815197](#) Small S\$319.00

W61 x D82 x H66cm



Ottoman [August]

[15815173](#) Large S\$319.00

W74 x D61 x H37cm

[15815203](#) Small S\$289.00

W61 x D61 x H37cm



Box [August]

[76580577](#) Shelf S\$239.00

W75 x D32 x H41cm







[76580584](#) Table S\$319.00

W59 x D75 x H32cm

*All covers sold separately. Kindly refer to page 51 for cover selection.

Sofa Chair Cover

Pick a cover that best suits your home. Choose from the different colours and materials in the selection below.

Cover		Cotton	Cotton Polyester		Cotton Chenille		
							
Sofa		Dark Brown	Beige	Brown	Light Grey	Green	Charcoal Grey
Wide Arm Sofa	2.5 Seater	18531967 S\$259.00	• 18022182 S\$389.00	18022168 S\$389.00	61048499 S\$389.00	• 61048369 S\$389.00	61048239 S\$389.00
	Ottoman	18532025 S\$49.00	• 18022069 S\$63.00	18022052 S\$63.00	61048543 S\$63.00	• 61048413 S\$63.00	61048284 S\$63.00
Unit Sofa [August]	With Armrest L		• 15435777 S\$239.00	• 15439072 S\$239.00	15449118 S\$239.00	• 15453351 S\$239.00	
	With Armrest S		• 15435807 S\$209.00	• 15439102 S\$209.00	15449149 S\$209.00	• 15454303 S\$209.00	
	Armless L		• 15435784 S\$209.00	• 15439089 S\$209.00	15449125 S\$209.00	• 15454280 S\$209.00	
	Armless S		• 15435814 S\$179.00	• 15439119 S\$179.00	15449156 S\$179.00	• 15454464 S\$179.00	
	Ottoman L		• 15435791 S\$179.00	• 15439096 S\$179.00	15449132 S\$179.00	• 15454297 S\$179.00	
	Ottoman S		• 15435821 S\$129.00	• 15439126 S\$129.00	15449163 S\$129.00	• 15454532 S\$129.00	
Living Dining Series	Sofa Chair		• 15435845 S\$99.00	• 15439140 S\$99.00	15256471 S\$99.00	• 15256488 S\$99.00	
	Bench 1 [July]		• 15435852 S\$79.00	• 15439157 S\$79.00	15257096 S\$79.00	• 15257102 S\$79.00	
	Bench 2		• 15436705 S\$49.00	• 15439164 S\$49.00	15257133 S\$49.00	• 15257140 S\$49.00	

•Only for Special Order.

Beads Cushion

Flexible sofa that freely moulds its shape to your sitting preference with ultra micro beads and stretchable cover that wraps your body in comfort.



Beads Cushion	
61049182	S\$199.00
W65 x D65 x H43cm	
Beads Cushion Cover	
1 61048888	Grey Beige S\$49.00
2 15117178	Cherry S\$49.00
3 61048871	Dark Brown S\$49.00
4 61048895	Brick S\$49.00
5 76580294	Navy S\$49.00
W65 x D65 x H43cm	



Ultra micro beads of approximately 0.5mm are resistant to deformation which provides an extra soft sitting comfort.

When placed on its side

Wraps your body from waist till neck and keeps you in your favourite posture. Ideal for reading and watching television.

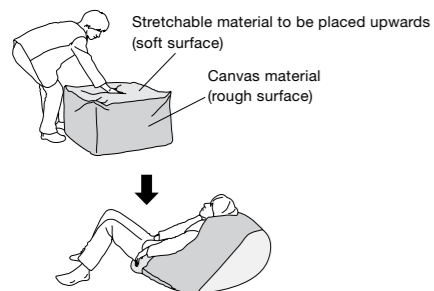

When placed upright

Sinks and widens in all directions making it comfortable when resting.

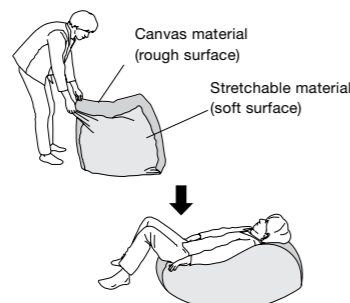

Reclining Sofa Relax Chair

MUJI's reclining sofa has been designed to achieve that relaxed reclining comfort that you need. The wavy wooden framed relax chair comes with padded cushions for a different level of seating comfort.



Highback Reclining Sofa - 2 Seater

1 61790305	Grey Beige	S\$899.00
15084180	Brown	S\$899.00
W148 x D100 x H93cm		



Highback Reclining Sofa - 1 Seater

15084203	Grey Beige	S\$469.00
2 15084173	Brown	S\$469.00
W74 x D100 x H93cm		



Highback Reclining Sofa - Footstool

3 15084302	Grey Beige	S\$159.00
15084197	Brown	S\$159.00
W68.5 x D43 x H38cm		

High back design offering greater support up to the head

The high back design allows you to lie back and relax on the sofa. The cushions gently support your body right up to the neck position.

With reclining function

The reclining function of this chair is for both the backrest and the headrest, which allows you to adjust the sofa to your desired angle. The backrest is adjustable to six positions by the lever; and the headrest can be adjusted to six positions, even when the sofa is laid flat.



With reclining function

The cushions are made with soft and fluffy feathers to provide an exceptional sitting comfort. Urethane chips are mixed with feathers to enhance cushion resilience. The cover is detachable from the cushion body. If wrinkles are observed on the sofa surface, remove the cover and knead the cushion to puff it up.



Relax Chair With Ottoman Set

4 76269397	Grey Beige	S\$239.00
5 76269335	Brown	S\$239.00
W62 x D83 x H101.5cm		



Relax Chair Cushion

6 76269410	Grey Beige	S\$79.00
7 76269403	Brown	S\$79.00



Tables & Chairs

Wood Tables and Chairs

Enjoy every meal and tea-time. The joy in our everyday life begins when we gather around the table.



Ash Table 1
 [18120918] Natural
 W165 x D80 x H72cm
 Tolerable weight: 40kg



Ash Table 2
 [18120925] Natural
 W140 x D80 x H72cm
 Tolerable weight: 40kg



Ash Side Table Bench
 [18121823] Natural
 W37 x D37 x H44cm
 Tolerable weight: 15kg



Ash Extension Table 1
 [18120970] Natural
 W140-190 x D80 x H72cm
 Tolerable weight: 40kg, extension plate 10kg



Ash Bench
 [18121038] Natural
 W100 x D37 x H44cm
 Tolerable weight: Middle shelf 10kg



Pinewood Foldable Table
 [18499441] High
 W80 x D50 x H70cm
 [18499434] Low
 W80 x D50 x H35cm
 Tolerable weight: 15kg



When Folded



Back



Combination With Chair



Oak Chair With Beige Seat
 [76269359] Natural
 W38 x D48.5 x H79cm



Ash Chair
 [15939664] Natural
 W38.5 x D48 x H81.5cm



Beech Folding Chair
 1 [47178456] Wooden Seat
 W46 x D52 x H81cm
 2 [47178463] Cloth Seat
 W46 x D52 x H81cm



When Folded

Low Table

Use this U-Shape furniture as an informal table that can be used throughout the year as a low table. Now available in square, rectangular and even oblong designs.



Ash Plywood Oval Table
 [47549256] W140cm
 W140 x D79 x H35cm
 S\$599.00
 1 [47549263] W110cm
 W110 x D62 x H35cm
 S\$499.00
 Tolerable weight: 40kg



Ash Low Table
 [18120833] Natural
 W120 x D60 x H35cm
 S\$419.00
 2 [18120840] Natural
 W90 x D60 x H35cm
 S\$339.00
 [18120857] Natural
 W90 x D45 x H35cm
 S\$309.00
 Tolerable weight: 40kg, 5kg per drawer



Legless Chair (Body) - Large
 [18481286] Natural
 W57 x D102 x H10cm
 S\$79.00



Legless Chair (Body) - Small
 [18481293] Natural
 W46 x D86 x H10cm
 S\$59.00

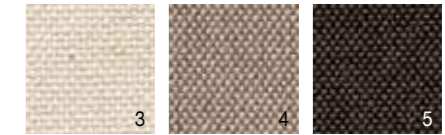

Legless Chair (Cover) - Large
 3 [76936954] Canvas Ecrú
 S\$39.00
 4 [18531653] Cotton Beige
 S\$43.00
 5 [18531677] Cotton Brown
 S\$43.00

Legless Chair (Cover) - Small
 3 [76936961] Canvas Ecrú
 S\$29.00
 4 [18531660] Cotton Beige
 S\$33.00
 5 [18531684] Cotton Brown
 S\$33.00



Ash Multi-Purpose U-Shape - W70cm
 [18121656] Natural
 S\$139.00
 [18121670] Brown
 S\$139.00
 W70 x D30 x H35cm
 Tolerable weight: 40kg when used as a shelf



Ash Multi-Purpose U-Shape - W35cm
 [18121663] Natural
 S\$109.00
 [18121687] Brown
 S\$109.00
 W35 x D30 x H35cm
 Tolerable weight: 40kg when used as a shelf



Solid Oak Series

Featuring hardness, solidness and durability, oak is the ideal material for a furniture that will be used for a long period of time. The texture of oak also becomes more attractive over time.



Oak Solid Wood Bed

- 18920723 Single S\$799.00
W105 x D202 x H75cm
- 18920747 Double S\$1199.00
W148 x D202 x H75cm
- 18920754 Queen S\$1299.00
W168 x D202 x H75cm



Example of Use With Storage Box

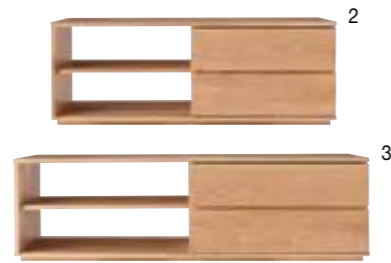

Oak Solid Wood Audio Visual Rack

- 2 18922093 S\$799.00
W120 x D40 x H44cm
Tolerable weight: Top board 40kg, 5kg per drawer, movable shelf 5kg
- 3 18922109 S\$999.00
W150 x D40 x H44cm
Tolerable weight: Top board 65kg, 5kg per drawer, movable shelf 5kg



Drawer

Example of Use With TV - 58" / 42"



Oak Solid Wood Table

- 18921171 Large S\$939.00
W140 x D80 x H72cm
Tolerable weight: 40kg



Combination With Chair



Oak Solid Wood Chair With Beige Seat

- 76269359 S\$249.00
W38 x D48.5 x H79cm



Oak Solid Wood Rectangle Bench

- 18921232 S\$739.00
W120 x D37.5 x H44cm
Tolerable weight: Storage 20kg



Example of Use



Oak Solid Wood Bench

- 4 18710294 Large S\$189.00
W100 x D30 x H44cm
- 5 18710300 Small S\$159.00
W45 x D30 x H44cm

HOME DELIVERY

* With effect from June 2014

Delivery Time	Delivery charges for purchases below S\$500	Delivery charges for purchases above S\$500
Monday - Friday		
10:00am - 7:00pm	S\$40	Free
7:00pm - 9:00pm	S\$60	S\$20
Saturday		
10:00am - 6:00pm	S\$60	S\$20

No deliveries on Sunday and Public Holidays. Labour charge for walk-up apartment is at S\$10 per level.

Delivery service is based on single destination within Singapore only. Please approach our staff for further enquiries.

MUJI (SINGAPORE) Pte Ltd reserves the right to amend the above Terms & Conditions without prior notice.



MUJI
無印良品

www.muji.com.sg/
www.facebook.com/muji.sg

313@somerset	#B2-38 to 41 & 47 to 49	Tel: 6634 5053
Bugis Junction	#03-10F	Tel: 6336 7885
ION Orchard	#B4-16	Tel: 6509 9321
Jem	#04-33 to 37	Tel: 6339 2558
Marina Square	#02-326 to 330	Tel: 6336 6123
Paragon Orchard	#04-36 to 38	Tel: 6735 0123
Tampines 1	#03-07	Tel: 6509 9733
VivoCity	#02-198	Tel: 6376 8023

2014 © MUJI (Singapore) Pte. Ltd. All product and price information are correct as of print, and may be subject to change. Any dimensions quoted are for guidance only. All products are subject to availability. Refer to in-store display for latest updated pricing. All Rights Reserved. Published June 2014.