



2015 Furniture Catalogue



MUJI
無印良品

www.muji.com/sg/
www.facebook.com/muji.sg

313@somerset	#B2-38 to 41 & 47 to 49	Tel: 6634 5053
Bugis Junction	#03-10F	Tel: 6336 7885
ION Orchard	#B4-16	Tel: 6509 9321
Jem	#04-33 to 37	Tel: 6339 2558
Marina Square	#02-326 to 330	Tel: 6336 6123
Paragon Orchard	#04-36 to 38	Tel: 6735 0123
Tampines 1	#03-07	Tel: 6509 9733
VivoCity	#02-198	Tel: 6376 8023

2015 © MUJI (Singapore) Pte. Ltd. All product and price information are correct as of print, and may be subject to change. Any dimensions quoted are for guidance only. All products are subject to availability. Refer to in-store display for latest updated pricing. All Rights Reserved. Published July 2015.



無印良品

2015 Furniture Catalogue

Storage	6	Storage Furniture	7
		Storage Items	18
		Desk Storage	30
Bedding	35	Bed	36
		Mattress, Bed Pad	40
		Futon, Pillow	41
Sofa	42	Living Dining Chair	43
		Wide Arm Sofa	45
		Unit Sofa	46
		Sofa Bench	48
		Beads Cushion	50
		Reclining Sofa	51
		Relax Chair	51
Tables & Chairs	52	Wood Furniture	53
		Low Table	54
		Beech Wood Series	54



Pictorial Indicator Used In Catalog

 15
 Prefabrication Unit +
 Assembly Time (min)

 Can be
 assembled alone

 To be assembled by
 two or more persons

 Product with optional
 parts sold separately

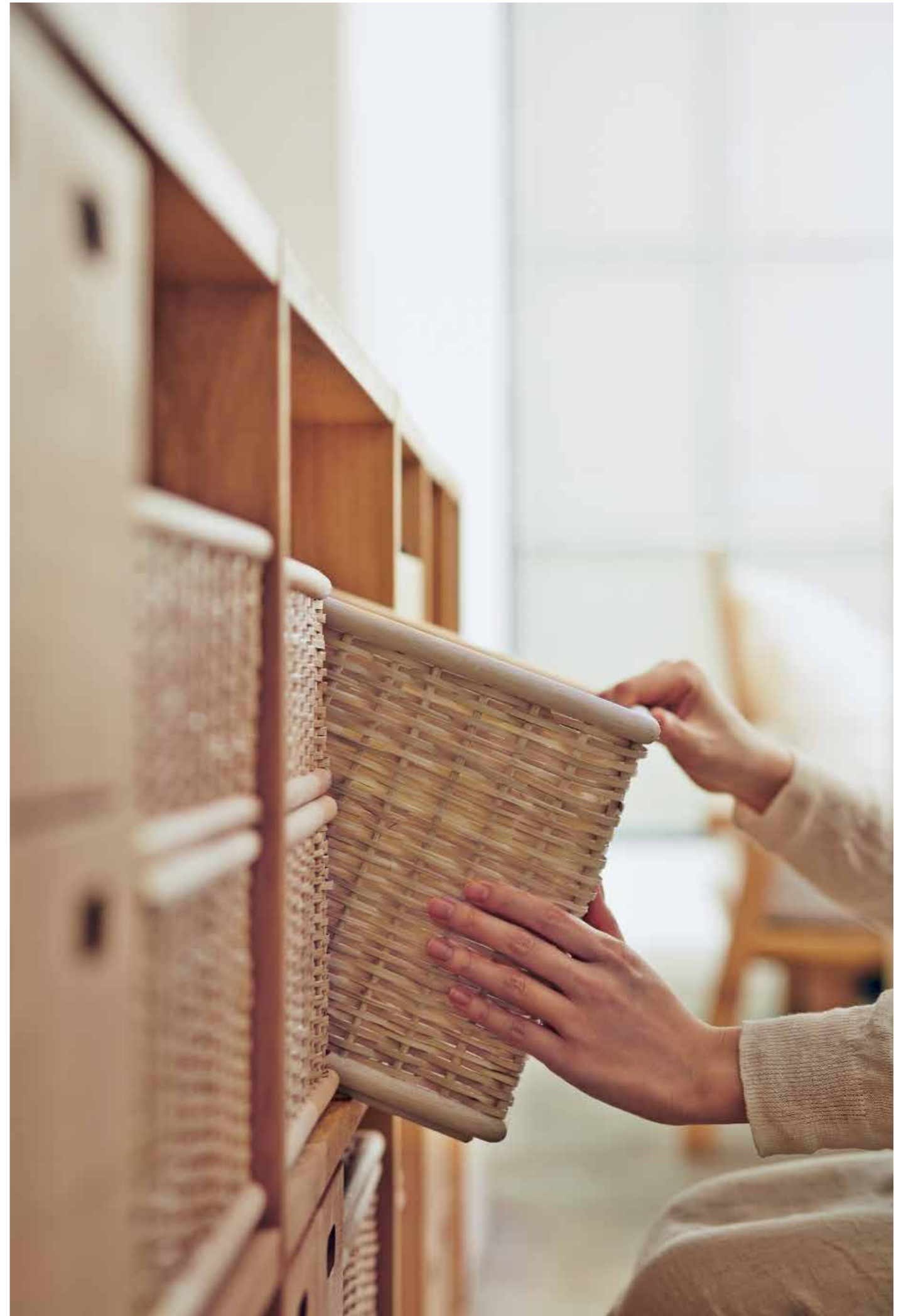

 Requires Phillips
 Screw Driver



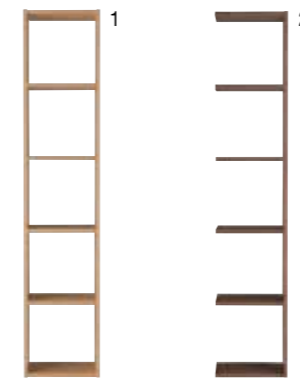

Stacking Shelf

A simple storage furniture that allows you to partition the wall flexibly and store your stuff as you desire. This shelf comes in convenient sizes for storage. It also allows compatible storage items in flexible



Grid Shelf 5 Row Base

1	18121335	Oak	S\$309.00
	37265646	Walnut	S\$339.00
W42 x D28.5 x H200cm			

Grid Shelf 5 Row Add On

2	18121373	Oak	S\$279.00
	18218646	Walnut	S\$309.00
W40 x D28.5 x H200cm			

Tolerable weight: 20kg per shelf, overall shelf 60kg



Grid Shelf 3 Row Base

3	18121328	Oak	S\$239.00
	37265639	Walnut	S\$279.00
W42 x D28.5 x H121cm			

Grid Shelf 3 Row Add On

4	18121366	Oak	S\$229.00
	37265660	Walnut	S\$259.00
W40 x D28.5 x H121cm			

Tolerable weight: 20kg per shelf, overall shelf 40kg

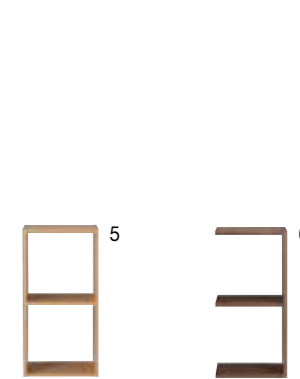

Grid Shelf 2 Row Base

5	37263154	Oak	S\$199.00
	37265622	Walnut	S\$229.00
W42 x D28.5 x H81.5cm			

Grid Shelf 2 Row Add On

6	18121359	Oak	S\$179.00
	37265653	Walnut	S\$209.00
W40 x D28.5 x H81.5cm			

Tolerable weight: 20kg per shelf, overall shelf 30kg

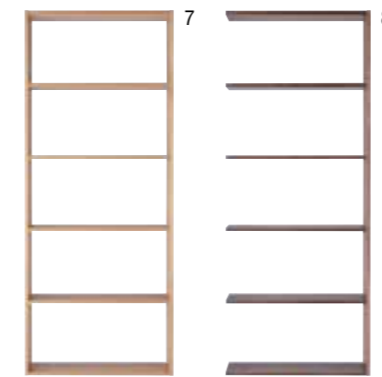

Grid Shelf 5 Wide Base

7	18340057	Oak	S\$399.00
	37265707	Walnut	S\$439.00
W81.5 x D28.5 x H200cm			

Grid Shelf 5 Row Wide Add On

8	18482887	Oak	S\$369.00
	37265738	Walnut	S\$399.00
W79.5 x D28.5 x H200cm			

Tolerable weight: 20kg per shelf, overall shelf 60kg

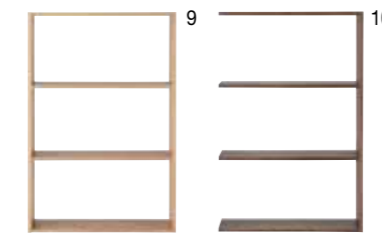

Grid Shelf 3 Wide Base

9	18340040	Oak	S\$329.00
	37265691	Walnut	S\$359.00
W81.5 x D28.5 x H121cm			

Grid Shelf 3 Row Wide Add On

10	18482863	Oak	S\$309.00
	37265721	Walnut	S\$339.00
W79.5 x D28.5 x H121cm			

Tolerable weight: 20kg per shelf, overall shelf 40kg

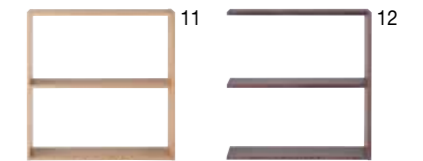

Grid Shelf 2 Row Wide Base

11	18340033	Oak	S\$279.00
	37265684	Walnut	S\$309.00
W81.5 x D28.5 x H81.5cm			

Grid Shelf 2 Row Add On

12	18482849	Oak	S\$259.00
	18482832	Walnut	S\$289.00
W79.5 x D28.5 x H81.5cm			

Tolerable weight: 20kg per shelf, overall shelf 30kg



Storage Furniture



Grid Shelf 5R3L Add On
 1

18924516	Oak	S\$499.00
37265745	Walnut	S\$569.00

 W120 x D28.5 x H200cm
 Tolerable weight: Top storage area: overall shelf 20kg, centre top board: 40kg
 *Only for special order.



Grid Shelf 5R2L Add On
 2

18955183	Oak	S\$399.00
37267039	Walnut	S\$479.00

 W80 x D28.5 x H200cm
 Tolerable weight: Top storage area: overall shelf 20kg, centre top board: 30kg
 *Only for special order.



Grid Shelf 5R3L Add On (T-shape)
 3

18924523	Oak	S\$199.00
37265752	Walnut	S\$229.00

 W118 x D28.5 x H40cm
 Tolerable weight: Top board: 40kg
 *Only for special order.



Grid Shelf 5R2L Add On (T-shape)
 4

18955206	Oak	S\$129.00
37267048	Walnut	S\$159.00

 W78 x D28.5 x H40cm
 Tolerable weight: Top board: 30kg
 *Only for special order.



| Stacking Shelf Set |

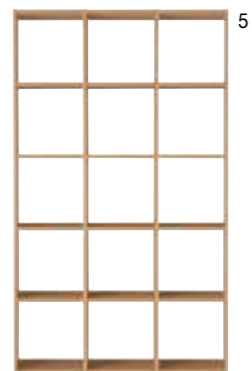

Grid Shelf Set 5R3L
 5

37263611	Oak	S\$729.00
37267053	Walnut	S\$799.00

 W122 x D28.5 x H200cm
 Tolerable weight: 20kg per shelf, overall shelf 90kg



Grid Shelf Set 5R2L
 6

61164670	Oak	S\$519.00
37267060	Walnut	S\$569.00

 W82 x D28.5 x H200cm
 Tolerable weight: 20kg per shelf, overall shelf 60kg



Grid Shelf Set 3R3L
 7

37263635	Oak	S\$609.00
37267077	Walnut	S\$699.00

 W122 x D28.5 x H121cm
 Tolerable weight: 20kg per shelf, overall shelf 60kg



Grid Shelf Set 3R2L
 8

61164717	Oak	S\$399.00
37267084	Walnut	S\$469.00

 W82 x D28.5 x H121cm
 Tolerable weight: 20kg per shelf, overall shelf 40kg



| Stacking Drawers |



Stacking Chest Drawers 2 Tiers
 9

18708703	Oak	S\$109.00
18922222	Walnut	S\$129.00

 W37 x D28 x H37cm



Stackable Chest 4 Tier Shelf
 10

61362533	Oak	S\$129.00
61362540	Walnut	S\$149.00

 W37 x D28 x H37cm



Stacking Chest Drawers 4 Tiers
 11

18708710	Oak	S\$129.00
18922239	Walnut	S\$149.00

 W37 x D28 x H37cm



Tolerable weight: Top board 5kg, 3kg per drawer, overall 5kg

Structure of Stacking Shelf

You can build your own storage unit just by combining the basic and additional units.

As shown in the drawing below, the units can be easily combined by joining the steel pipes inside the partition plate and then fastening them with bolts.

Stacking Method

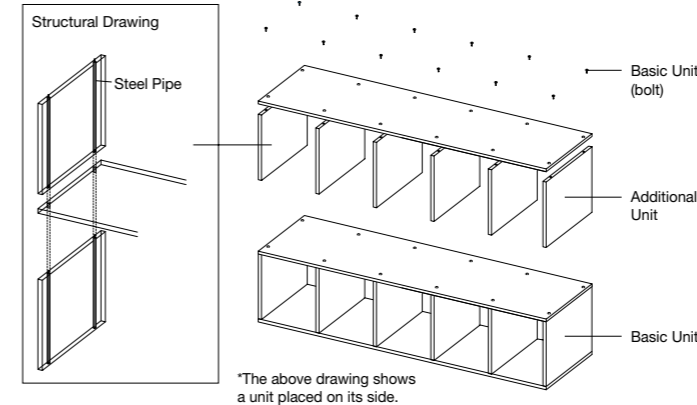

Examples of combinations and load capacity

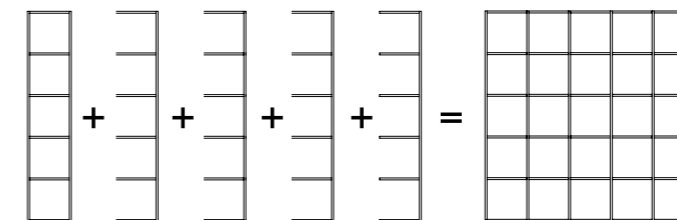

This is the combination method to join the units placed upright in a sideways direction.

Load capacity: Total 150kg = 60kg x 5units / 2

For combined unit:
 Total load capacity: Load capacity of a unit x number of units / 2

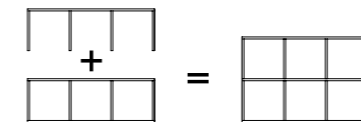

One set of 35-tier basic unit + Four sets of 3-tier additional parts.

This is the combination method to join the units placed on their side in an upward direction.

Load capacity: Total 40kg = 40kg x 2units / 2

For combined unit:
 Total load capacity: Load capacity of a unit x number of units / 2

Example of Use

Using the unit with partition plates removed and only with steel pipes

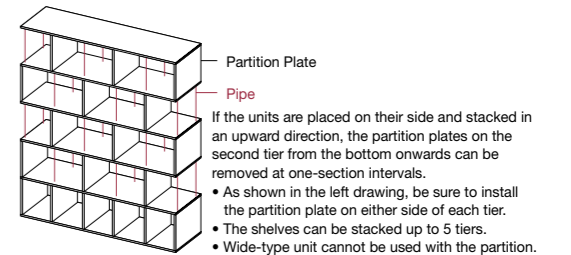
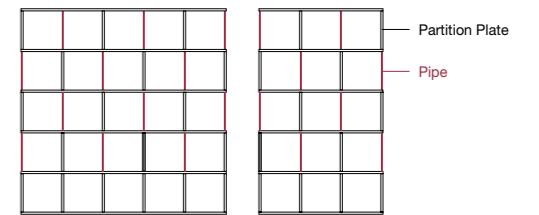

Combining units with different number of tiers

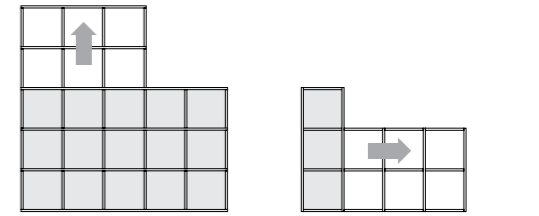

The shelves can be stacked up to 5 tiers.
 • Wide-type unit cannot be used with the partition.

Combining units with different widths

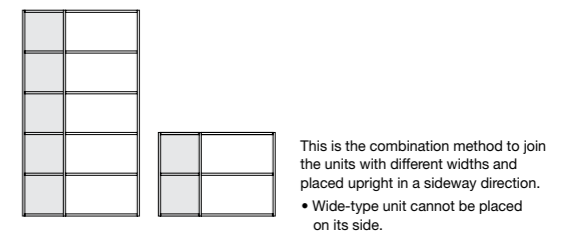

Using the unit as a partition

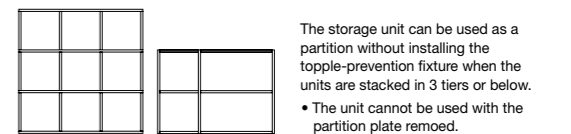

Structure of Open-Type Stacking Shelf

You can build your own storage unit just by combining the basic and open-type parts with steel pipes.

Combination Example 1

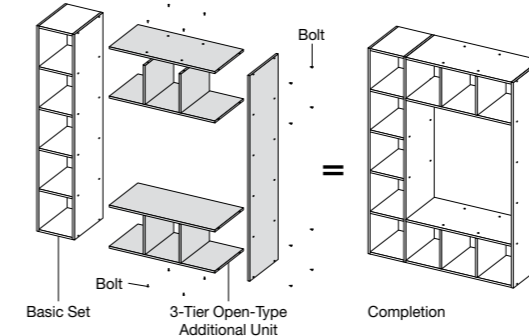

Combination Example 2

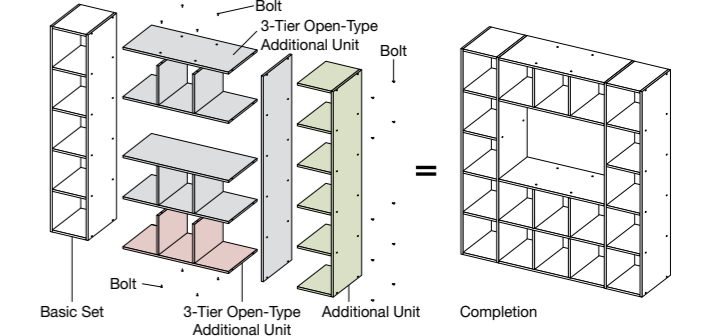



Stacking Cabinets

Build your own storage unit by combining the basic set and additional parts. By combining additional parts, you can make an ideal storage unit or audio visual rack for your living and bedroom.



Stackable Cabinet Set - 162.5cm
 1 [15256983](#) S\$399.00
 W162.5 x D39.5 x H45cm
 Tolerable weight: Top board 65kg, 5kg per shelf

Stackable Cabinet Set Add On - 162.5cm
 2 [18805990](#) S\$359.00
 W162.5 x D39.5 x H40cm



Stackable Cabinet Set - 82.5cm
 3 [15256976](#) S\$239.00
 W82.5 x D39.5 x H45cm
 Tolerable weight: Top board 40kg, 5kg per shelf

Stackable Cabinet Set Add On - 82.5cm
 4 [18805976](#) S\$209.00
 W82.5 x D39.5 x H40cm



Stackable Cabinet High Add On
 5 [18708468](#) S\$569.00
 W162.5 x D39.5 x H79.5cm
 Tolerable weight: Top board 30kg
 The high type (additional set) can only be installed on the second stack and 1 stack of the additional set can be added onto it (width 162.5cm type only)

Additional Parts



Stackable Cabinet Desk Unit Oak
 4 [76252252](#) S\$609.00
 W82.5 x D39.5 x H165cm



Stacking Cabinet Dividing Board
[18806003](#) S\$33.00
 T2.5 x D37.5 x H37.5cm



Stackable Cabinet Glass Door
[18806034](#) Set of 2 pieces S\$49.00
 Glass door type can only be used on the bottom stack. It



Stackable Cabinet Drawer Large
[18806010](#) S\$63.00
 W77.5 x D37.5 x H17.5cm



Stackable Cabinet Wooden Door
[18806027](#) Set of 2 pieces S\$63.00

Construction of the stacking cabinet

Stack them up to get the style convenient for you and combine them with the optional parts to get a really handy cabinet.

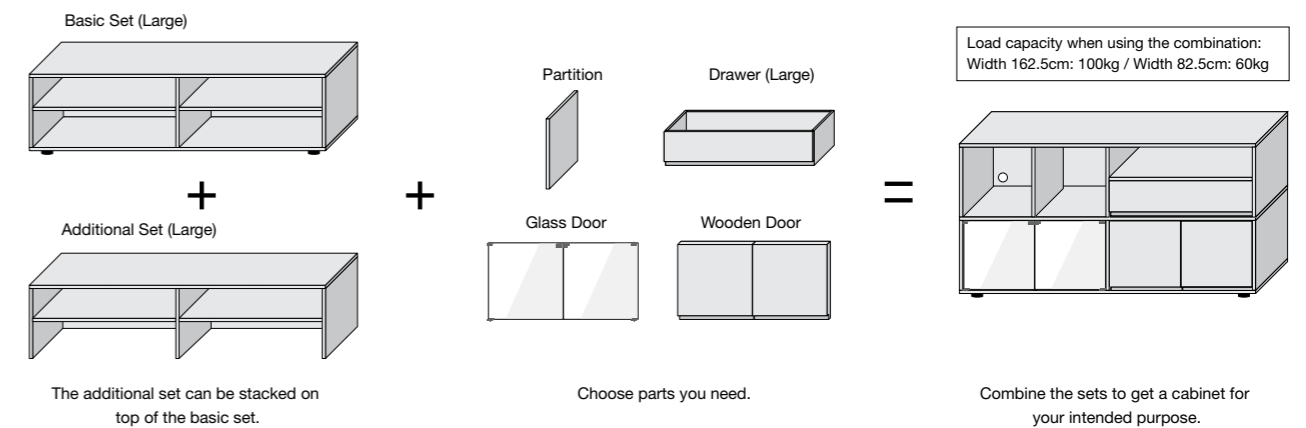

- Tolerable load when used in combination
 Width: 162.5cm: 100kg in total
 Width: 82.5cm: 60kg in total
- Do not place a TV set whose size protrudes out of the top board.
- Drawers can be fixed up to the third tier.
- For safety reasons, please restrain the use of glass doors at the lowest tier as a precautions against breakages and falling out.

- The sets can be stacked up to 5 tiers. The legs can also be removed. However, a movable rack must be fixed at that location. In addition, the glass or wooden door cannot be used at that location. the back boards at locations using the high type cannot be removed. (Used it when using large AV amplifiers or appliances that generate high heat.)

Wooden Storage

A warm wooden storage that can be easily used in the living room, dining room, kitchen or even bedroom. This series has standardized depth for easy combination with other storage range. Choose and arrange at your will.



Oak Chest 4 Row - 120cm
 [15874842] Natural **S\$799.00**
 W120 x D40 x H83cm
 Tolerable weight: Top board 30kg, 5kg per drawer



Oak Chest 4 Row - 80cm
 [15874859] Natural **S\$469.00**
 W80 x D40 x H83cm
 Tolerable weight: Top board 30kg, 5kg per drawer



Oak Chest 6 Row - 80cm
 [15874866] Natural **S\$799.00**
 W80 x D40 x H119.5cm
 Tolerable weight: Top board 30kg, 5kg per drawer



Oak Cabinet 3 Doors
 [15877843] Natural **S\$799.00**
 W120 x D40 x H83cm
 Tolerable weight: Top board 30kg, 10kg per shelf



Oak Cabinet 2 Doors
 [15877829] Natural **S\$579.00**
 W80 x D40 x H83cm
 Tolerable weight: Top board 30kg, 10kg per shelf



Oak Dresser With Stool
 [15874972] Natural **S\$469.00**
 W46 x D36.5 x H72cm
 Tolerable weight: Top board 15kg, storage unit 10kg



Side Furniture, Mirror, Coat Stand

These side furnitures are made from wood, aluminium and steel that is easy to match any home furnitures. Also available are coat hangers and mirrors that comes in different size and materials for you to choose from.



Oak Mirror
 [15874880] **S\$189.00**
 W44 x D33 x H150.5cm



Pinewood Mirror
 [18122868] **S\$79.00**
 W36 x D50 x H145cm



Aluminium Compact Mirror With Tray
 [15574940] Large **S\$43.00**
 W20.5 x D18 x H34-44cm
 [15574957] Small **S\$33.00**
 W17 x D14 x H27cm



Beech Coat Stand
 [61013107] **S\$99.00**
 W48 x D42 x H173.5cm
 Tolerable weight: 15kg



Oak Coat Hanger
 [15874873] **S\$169.00**
 W44 x D53.5 x H150.5cm
 Tolerable weight: Shelf 10kg, Hanger 10kg



Steel Tray Stand
 [76580607] **S\$59.00**
 W45.5 x D34.5 x H51.5cm
 *Wooden Tray sold separately.



Wooden Tray
 [61010502] Ash **S\$29.00**
 W46 x D35 x H1.5cm



Ash Dust Box
 [18340170] **S\$43.00**
 W28.5 x D15.5 x H30.5cm



Ash Dust Box With Lid
 [76856085] **S\$49.00**
 Dia23.5 x H30cm



Aluminium Dust Box
 [76023739] **S\$16.00**
 Dia22 x H25cm

Steel Unit Shelf

Select and combine from the various types of shelving, to create a shelving unit that fits your home.



Additional Parts for Steel Unit Shelf - Depth 41cm Type | Parts that can be combined with steel unit shelves.

Shelf Board

Steel and wooden shelf boards that create more expression to the overall shelf when combined with the side shelf stand are also available.



Add On Steel Shelf Board - Grey

61361987	Width 112cm	S\$43.00
61179551	Width 84cm	S\$33.00
61179568	Width 56cm	S\$29.00
61179575	Width 42cm	S\$23.00

Steel Shelf Board:
Epoxy powder coated

Add On Wooden Shelf Board - Grey

61179582	Width 84cm	S\$49.00
61179599	Width 56cm	S\$39.00
61179605	Width 42cm	S\$33.00

Wooden Shelf Board:
MDF / Natural wood veneer
Hook: Steel

Side Shelf Stand

This side shelf stand can be used to create original shelf designs.

Add On Side Shelf Stand - Grey

5	61179629	Large	S\$49.00
	61179636	Medium	S\$39.00
	61179643	Small	S\$29.00
	61179650	Mini	S\$19.00

Size modules for Add On Side Shelf Stand

Large: Height 175.5cm
Medium: Height 120cm
Small: Height 83cm
Mini: Height 46cm

[Tolerable Weight - Depth 41cm Type]	[Usable Dimension of Shelf - Depth 41cm Type]
Per Shelf: 30kg	Width 112cm: W108 x D39.5cm
Height 175.5cm: Up to 100kg	Width 84cm: W80 x D39.5cm
Height 120cm: Up to 75kg	Width 56cm: W52 x D39.5cm
Height 83cm: Up to 50kg	Width 42cm: W38 x D39.5cm
Height 46cm: Up to 30kg	

*Total weight if multiplied evenly per shelf.

Basic Set - Depth 41cm Type | Available in grey steel and grey wood, and in different size for basic shelf combination.

Steel Shelf Set - Grey

1	61179391	Wide / Large	S\$279.00
	61179353	Large	S\$219.00
	61179407	Wide / Medium	S\$209.00
	61179360	Medium	S\$169.00
	61179414	Wide / Small	S\$159.00
2	61179377	Small	S\$139.00
	61179421	Wide / Extra Small	S\$129.00
	61179384	Extra Small	S\$109.00

Wooden Shelf Set - Grey

3	61179483	Wide / Large	S\$349.00
	61179438	Large	S\$309.00
	61179490	Wide / Medium	S\$269.00
	61179445	Medium	S\$219.00
	61179506	Wide / Small	S\$199.00
4	61179452	Small	S\$179.00
	61179513	Wide / Extra Small	S\$179.00
	61179469	Extra Small	S\$139.00

Wide / Large: W86 x D41 x H175.5cm		Large: W58 x D41 x H175.5cm	
Wide / Medium: W86 x D41 x H120cm		Medium: W58 x D41 x H120cm	
Wide / Small: W86 x D41 x H83cm		Small: W58 x D41 x H83cm	
Wide / Extra Small: W86 x D41 x H46cm		Extra Small: W58 x D41 x H46cm	



Crossbar



Crossbar - Grey

61789941	Extra Large	Width 112cm	S\$13.00
61179667	Large	Width 84cm	S\$10.90
61179674	Small	Width 42-56cm	S\$9.90

The use of the cross bar is to give stability to joined shelves.

Reinforcing Part



Side Shelf Stand Reinforcing Part - Grey

61179766	Width 84cm	Usable dimension: W78 x D36cm	S\$29.00
61179773	Width 56cm	Usable dimension: W50 x D36cm	S\$23.00

When used in exchange with shelf boards, the created space at the lower shelf can be used for washing machine or refrigerator.

Caution: When joining unit shelf's parts | The unit shelf must not be joined as shown below:

Side Shelf Stand - Reinforcing Part x Shelf Board
(Do not fix in parallel)

Side Panels x Added Side Shelf Stand
(Do not use side panel when shelf is added)

Back Panels x Side Shelf Stand Reinforcing Part
(Do not fix overlapping each other)

Side Panels x Added Side Shelf Stand
(Do not fix overlapping the top and bottom edges of the side panels)

Wardrobe Bar



Stainless Steel Wardrobe Bar

61179797	Width 84cm	S\$33.00
61179803	Width 56cm	S\$29.00

Caster



Caster

61179780	4Pcs set	S\$19.00
----------	----------	----------



Pulp Board Storage

Light and durable storage boxes that can be placed upright or on its side. It is useful as a wall storage furniture, that can join up to 5 units sideways. Available in a wide selection of shapes and sizes.



Pulp Board Box A4 - 5 Rows
 47549201 S\$63.00
 W37.5 x D29 x H180cm
 Fixed shelf tolerable weight: 15kg per shelf, overall shelf 40kg



18121717 Slim S\$56.00
 W25 x D29 x H180cm
 Fixed shelf tolerable weight: 15kg per shelf, overall shelf 40kg

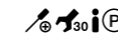

Pulp Board Box A4 - 4 Rows
 18511341 S\$53.00
 W37.5 x D29 x H144cm
 Fixed shelf tolerable weight: 15kg per shelf, overall shelf 35kg



18511358 Slim S\$49.00
 W25 x D29 x H144cm
 Fixed shelf tolerable weight: 15kg per shelf, overall shelf 35kg



Pulp Board Box A4 - 3 Rows
 47549195 S\$43.00
 W37.5 x D29 x H109cm
 Fixed shelf tolerable weight: 15kg per shelf, overall shelf 25kg



18121700 Slim S\$39.00
 W25 x D29 x H109cm
 Fixed shelf tolerable weight: 15kg per shelf, overall shelf 25kg



Pulp Board Box A4 - 2 Rows
 47549188 S\$26.00
 W37.5 x D29 x H73cm
 Fixed shelf tolerable weight: 15kg per shelf, overall shelf 20kg



18121694 Slim S\$23.00
 W25 x D29 x H73cm
 Fixed shelf tolerable weight: 15kg per shelf, overall shelf 20kg



Pulp Board Box Multi-Rack
 18121724 S\$53.00
 W37.5 x D17.5 x H109cm
 Tolerable weight: 8kg per fixed shelf, overall shelf 25kg



Pulp Board Box Free Rack
 18121731 S\$49.00
 W25 x D29 x H109cm
 Tolerable weight: 8kg per fixed shelf, overall shelf 25kg



Pulp Board Box with Caster
 61789712 S\$79.00
 W76 x D29 x H64cm
 Tolerable weight: 15kg per fixed shelf, moveable shelf 8kg, overall shelf 20kg
 Vertical position tolerable weight: 15kg per fixed shelf, overall shelf 20kg



Pulp Board Box Joint Clamp
 18960941 S\$3.90
 2Pcs Set



Vertical Position



Storage Items

Polypropylene (PP) Storage Case Series

Our PP Storage Case Series are multifunctional; they are stackable, packable and versatile enough to be utilised for practically anything. Combine different size storage case to match the space requirement and usage.

| PP Clothes Drawer | (W40 x D65cm)



[15112081] Large S\$29.00
 W40 x D65 x H30cm
 Allowed number of stacks: 6 stacks
 Can be fitted with casters (sold separately)



[15112098] Medium S\$23.00
 W40 x D65 x H24cm
 Allowed number of stacks: 7 stacks
 Can be fitted with casters (sold separately)



[15112104] Small S\$19.00
 W40 x D65 x H18cm
 Allowed number of stacks: 8 stacks
 Can be fitted with casters (sold separately)



Tolerable weight: about 7kg (with casters: 3.5kg)

| PP Closet Drawer | (W44 x D55cm)



[15199693] Large S\$29.00
 W44 x D55 x H30cm
 Allowed number of stacks: 6 stacks
 Can be fitted with casters (sold separately)



[15199709] Medium S\$23.00
 W44 x D55 x H24cm
 Allowed number of stacks: 7 stacks
 Can be fitted with casters (sold separately)



[15236640] Small S\$19.00
 W44 x D55 x H18cm
 Allowed number of stacks: 8 stacks
 Can be fitted with casters (sold separately)



Tolerable weight: about 7kg (with casters: 3.5kg)

Semi-transparent boxes - making the best use of polypropylene's natural colour

MUJI made away with the colouring process - a common process to create colourful polypropylene products - to develop these colourless products. Removing the colouring process not only brings the cost down but the semi-transparent result helps in the identification of contents kept in the case while at the same time not showing too much or rather only vaguely showing the contents of the case.

There are 4 series lined up for the large type; these are the "storage case", "clothing case", "closet case" and "wide case". Choose the width, depth and height that suit the size of your cupboard. You can also use the drawer type for dust-proofing or fit in the wheelers to ease transfers of the contents.

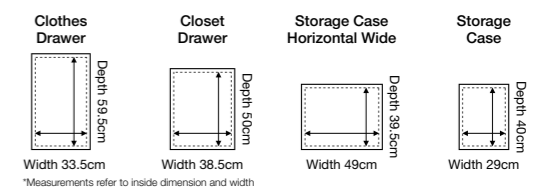

* Please follow the pre-set "allowable number of stacks" and "tolerable weight" to avoid any untoward accidents.
 * Due to the nature of polypropylene, there might be a slight variation in the hardening of the propylene cases. When stacked up, the height of each stack might slightly vary.

PP Storage Case Horizontal Wide | (W55 x D44.5cm)



76331476 Deep **S\$36.00**
 W55 x D44.5 x H30cm
 Tolerable weight: About 2kg (with casters: about 2.5kg)
 Allowed number of stacks: 6 stacks
 Can be fitted with casters (sold separately)



76331483 Large **S\$29.00**
 W55 x D44.5 x H24cm
 Tolerable weight: About 3kg (with casters: about 3.0kg)
 Allowed number of stacks: 5 stacks
 Can be fitted with casters (sold separately)



76331490 Small **S\$23.00**
 W55 x D44.5 x H18cm
 Tolerable weight: About 3kg (with casters: about 3.0kg)
 Allowed number of stacks: 5 stacks
 Can be fitted with casters (sold separately)



A wide storage case that can hold 2 pieces of shirts or sweaters side by side.



18510269 4 Tier **S\$99.00**
 W55 x D44.5 x H90cm
 Allowed number of stacks: 5 stacks
 (add on one stack Horizontal Wide case)
 Tolerable weight: About 9kg, 3kg per stack (with wheels on: about 3kg per stack)
 Can be fitted with casters (sold separately)
 The unit cannot be dismantled mid-way of drawers.

18510252 3 Tier **S\$73.00**
 W55 x D44.5 x H67.5cm
 Allowed number of stacks: 5 stacks
 (add on two stacks Horizontal Wide case)



Example of Use



With Casters

PP Storage Case | (W34 x D44.5cm)



18816156 Deep **S\$23.00**
 W34 x D44.5 x H30cm
 Allowed number of stacks: 6 stacks
 Can be fitted with casters (sold separately)



18816163 Large **S\$19.00**
 W34 x D44.5 x H24cm
 Allowed number of stacks: 7 stacks
 Can be fitted with casters (sold separately)



18816170 Small **S\$16.00**
 W34 x D44.5 x H18cm
 Allowed number of stacks: 9 stacks
 Can be fitted with casters (sold separately)

Tolerable weight: about 5kg (with casters: 3.0kg)

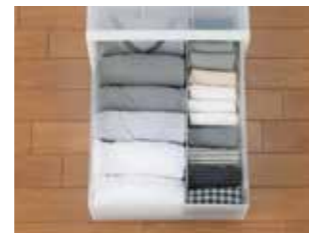

Combination Examples of Stackable Storage Units

*First 3 sets: Horizontal Wide, next 3 sets: Storage Case

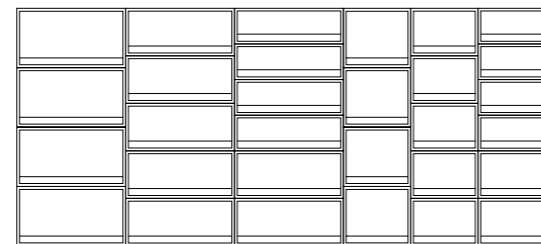

x 4 Units Deep x 5 Units Large x 4 Units Small x 2 Units Large x 4 Units Deep x 5 Units Large x 4 Units Small x 2 Units Large

PP Storage Drawer - Deep Type | (W26 x D37cm / Half: W14 x D37cm)



76749028 2 Drawers (with partition) **S\$23.00**
 W26 x D37 x H17.5cm
 Tolerable weight (with casters): About 2kg per drawer, 2kg top surface



37192447 **S\$16.00**
 W26 x D37 x H17.5cm
 Tolerable weight (with casters): About 4kg per drawer, 2kg top surface



Allowed number of stacks: 6 stacks
 Can be fitted with casters (sold separately)



76749035 Half / 1 Drawer (with partition) **S\$14.90**
 W14 x D37 x H17.5cm
 Tolerable weight (with casters): About 2kg per drawer, 2kg top surface



Allowed number of stacks: 4 stacks
 Can be fitted with casters (sold separately)



Example of Use

PP Storage Drawer - Shallow Type | (W26 x D37cm / Half: W14 x D37cm)



76749004 6 Drawers (with partition) **S\$49.00**
 W26 x D37 x H32.5cm
 Tolerable weight (with casters): About 1.5kg per drawer, 2kg top surface



37192430 3 Drawers **S\$29.00**
 W26 x D37 x H32.5cm
 Tolerable weight (with casters): About 3kg per drawer, 2kg top surface



Allowed number of stacks: 3 stacks
 Can be fitted with casters (sold separately)



76748984 2 Drawers (with partition) **S\$19.00**
 W26 x D37 x H12cm
 Tolerable weight (with casters): About 1.5kg per drawer, 2kg top surface



37192423 **S\$14.90**
 W26 x D37 x H12cm
 Tolerable weight (with casters): About 3kg per drawer, 2kg top surface



Allowed number of stacks: 10 stacks
 Can be fitted with casters (sold separately)



76749042 Half / 1 Drawer (with partition) **S\$13.00**
 W14 x D37 x H12cm
 Tolerable weight (with casters): About 1.5kg per drawer, 2kg top surface



Allowed number of stacks: 6 stacks
 Can be fitted with casters (sold separately)

PP Storage Drawer - Thin Type | (W26 x D37cm)



76749073 2 Tier **S\$19.00**
 W26 x D37 x H16.5cm
 Allowed number of stacks: 7 stacks



76749066 **S\$13.00**
 W26 x D37 x H9cm
 Allowed number of stacks: 13 stacks



Can be fitted with casters (sold separately)



Holds CDs Holds DVDs Holds A4 Documents



PP Rack | (W37 x D26cm)



37150621 Thin W37 x D26 x H9cm Tolerable weight: 3kg Allowed number of stacks: 13 stacks	S\$11.00	37150713 Deep W37 x D26 x H17.5cm Tolerable weight: 4kg Allowed number of stacks: 6 stacks	S\$13.90	37150720 Deep Large W37 x D26 x H26cm Tolerable weight: 5kg Allowed number of stacks: 4 stacks	S\$16.00
--	-----------------	--	-----------------	--	-----------------

Can be fitted with casters (sold separately)
The maximum stacking height is 120cm
Tolerable weight (without casters): 39kg
Tolerable weight (with casters or place reverse): 19.5kg



If you are stacking PP Rack on top of each other, please firmly insert the joint parts (provided with PP Rack) to all 4 corners.

*Even when stacking with other PP Storage such as PP Case Drawer Wide Series (3753/3777/3784/3791), please use the joint parts as well.

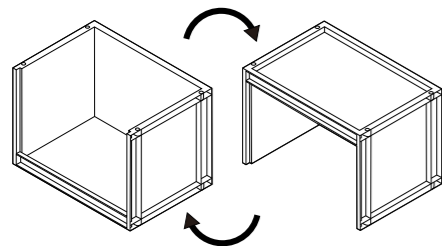
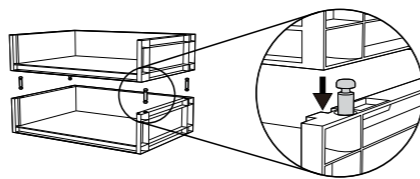

It can be used in both directions.

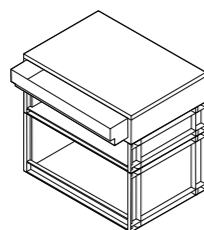

Can be stacked with PP Case Drawer Wide Series (3753/3777/3784/3791).

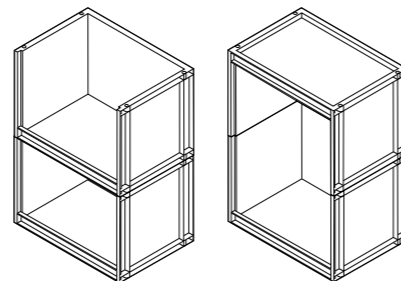

Can be stacked in both directions.

*Mix & match different height of rack. It can also be fitted with casters, to use it as a wagon.
*To efficiently utilize a storage space like under the sink. You can adjust the height according to the items you want to store.

PP Storage Drawer - Wide Type | (W37 x D26cm)



15253753 Thin **S\$14.90**
W37 x D26 x H9cm
Tolerable weight (with casters): About 1kg per drawer, 5kg on top
Allowed number of stacks: 13 stacks
Can be fitted with casters (sold separately)



15253784 Shallow **S\$16.00**
W37 x D26 x H12cm
Tolerable weight (with casters): About 1.5kg per drawer, 5kg on top
Allowed number of stacks: 10 stacks
Can be fitted with casters (sold separately)



15253777 2 Drawers **S\$19.00**
W37 x D26 x H9cm
Tolerable weight (with casters): About 0.5kg per drawer, 5kg on top
Allowed number of stacks: 13 stacks
Can be fitted with casters (sold separately)



15253791 Deep **S\$17.90**
W37 x D26 x H17.5cm
Tolerable weight (with casters): About 2kg per drawer, 5kg on top
Allowed number of stacks: 6 stacks
Can be fitted with casters (sold separately)



Example of Use

*This series can be combined with PP Storage Rack on pg22.

PP Carry Box With Lock |



18723713 Deep **S\$23.00**
W36 x D52 x H33cm
Tolerable weight (with casters): About 9kg
Allowed number of stacks: 5 stacks
Can be fitted with casters (sold separately)



18723690 Large **S\$19.00**
W36 x D52 x H16.5cm
Tolerable weight (with casters): About 7kg
Allowed number of stacks: 8 stacks
Can be fitted with casters (sold separately)



61793030 Small / Deep **S\$17.90**
W25.5 x D37 x H33cm
Tolerable weight: About 8kg
Allowed number of stacks: 5 stacks



18723676 Small **S\$14.90**
W25.5 x D37 x H16.5cm
Tolerable weight: About 5kg
Allowed number of stacks: 8 stacks



61793016 Small / Thin **S\$11.00**
W25.5 x D37 x H8.5cm
Tolerable weight: About 4kg
Allowed number of stacks: 14 stacks

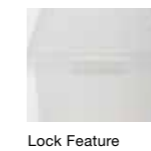

Lock Feature

PP Carry Box |



47807493 Deep **S\$19.00**
W36 x D51 x H33cm
Tolerable weight (with casters): About 9kg
Allowed number of stacks: 5 stacks
Can be fitted with casters (sold separately)



47686692 Large **S\$16.00**
W36 x D51 x H16.5cm
Tolerable weight (with casters): About 7kg
Allowed number of stacks: 8 stacks
Can be fitted with casters (sold separately)



47686685 Small **S\$11.00**
W25.5 x D36 x H16.5cm
Tolerable weight: About 5kg
Allowed number of stacks: 8 stacks



Foldable Type
47686715 Large **S\$23.00**
W36 x D51 x H24.5cm
Tolerable weight (with casters): About 7kg
Allowed number of stacks: 8 stacks
Can be fitted with casters (sold separately)



Foldable Type
47686708 Small **S\$16.00**
W36 x D25.5 x H16.5cm
Tolerable weight: About 5kg
Allowed number of stacks: 8 stacks



When Folded



| Additional Parts |



Stopper for PP Storage - Set of 4 pieces
 1 [47554908] Small S\$5.90
 2 [47554892] Big S\$5.90
 Silicone Rubber



Castor for PP Storage
 [15523788] Set of 4 pieces S\$6.30

Styrol Partition Plate PP Storage
 [47479584] Large / Set of 4 pieces S\$16.00
 W65.5 x D0.2 x H11cm



Non-Woven Partition Case - Set of 2 pieces
 [18182817] Large S\$9.60
 W24 x D38 x H12cm
 [18182824] Medium S\$7.90
 W16 x D38 x H12cm
 [18182831] Small S\$6.30
 W12 x D38 x H12cm

Examples of Use for Non-Woven Partition Case

Item Examples
 L T-Shirt, Collared Shirt, Sweater, Cardigan, Bath Towel
 M Camisole, T-Shirt, Pajamas, Face Towel
 S Socks, Shorts, Necktie, Mini Towel

PP Clothes Drawer

PP Closet

PP Storage Case

PP Storage Case Horizontal Wide

| PP Stocker |



(1) 1xMedium + 2xDeep

[15521821] 4 Tier S\$46.00
 W18 x D40 x H83cm
 Allowed number of stacks:
 Shallow (15880171): +3 stacks
 Medium (47721584): +2 stacks
 Deep (15880164): +1 stack



(2) 2xMedium + 1xDeep + 1xShallow

[15880188] 3 Tier S\$49.00
 W18 x D40 x H83cm
 Allowed number of stacks:
 Shallow (15880171): +3 stacks
 Medium (47721584): +2 stacks
 Deep (15880164): +1 stack



(3) 1xMedium + 3xDeep + 1xShallow

[15880195] 4 Tier S\$56.00
 W18 x D40 x H83cm
 Allowed number of stacks:
 Shallow (15880171): +3 stacks
 Medium (47721584): +2 stacks
 Deep (15880164): +1 stack



(4) 3xMedium + 1xDeep + 1xShallow

[15880201] 5 Tier S\$76.00
 W18 x D40 x H122cm
 Allowed number of stacks:
 Shallow (15880171): +3 stacks
 Medium (47721584): +2 stacks
 Deep (15880164): +1 stack



(5) 3xMedium + 1xDeep + 1xShallow

[15880218] 5 Tier S\$79.00
 W18 x D40 x H122cm
 Allowed number of stacks:
 Shallow (15880171): +3 stacks
 Medium (47721584): +2 stacks
 Deep (15880164): +1 stack



| PP Stacker Drawer Add On Parts |



[15880164] Deep S\$19.00
 W18 x D40 x H30.5cm
 Allowed number of stacks:
 4 stacks



[47721584] Medium S\$13.00
 W18 x D40 x H21cm
 Allowed number of stacks:
 5 stacks



[15880171] Shallow S\$11.00
 W18 x D40 x H11cm
 Allowed number of stacks:
 10 stacks



PP Wagon With Casters
 [15253807] 3 Tiers S\$29.00
 W29 x D41.5 x H83cm



* Remove the top cover or castor to add on PP stack in the desired combination to create your original design.
 * The maximum stacking height is 122 cm.

Note: The units cannot be dismantled mid-way

Stackable Storage Unit Guide & Size Module

Stackable Storage Unit Guide

	Maximum Estimated Load (with castor fitted on)			Approximate Single Tier Storage Capacity
	Per Tier	Top Surface	Total	
Add On [15880164] Deep Type	±5kg	±3kg	±30kg	1000ml bottles x 4
Add On [47721584] Medium	±5kg	±3kg	±30kg	350ml cans x 4
Add On [15880171] Shallow Type	±2.5kg	±3kg	±30kg	

Stackable Storage Unit Guide

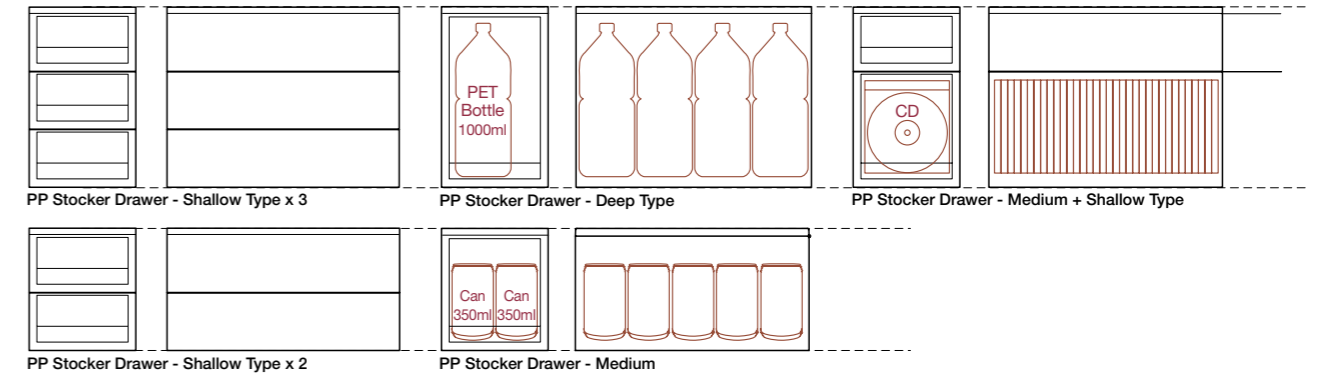

Example of Combination
 PP Stacker Drawer Add On - Shallow x 1
 + PP Stacker Drawer Add On - Medium x 1
 + PP Stacker Drawer Add On - Deep x 1
 + PP Storage Castor

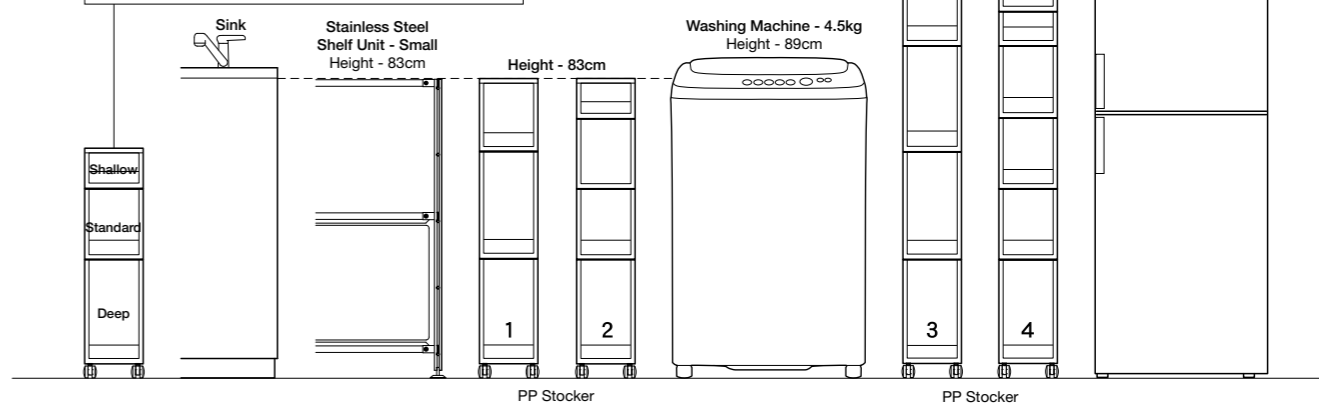



Stackable Storage Basket

Natural-looking hand-woven baskets made from good quality material from the Philippines. These baskets are light, easy to handle and smooth to the touch. These storage baskets comes in standard size for easy storing and stacking.



Bouli Rectangular Basket
47027907 Small S\$16.00
W37 x D26 x H12cm



Bouli Rectangular Basket Lid
18014026 S\$6.90
W37 x D26 x H2cm

*Can be used for S, M, L Basket



Bouli Rectangular Basket
47027914 Medium S\$19.00
W37 x D26 x H16cm



Bouli Rectangular Basket
18014002 Large S\$26.00
W37 x D26 x H24cm



Bouli Rectangular Basket
47027921 Extra Small S\$13.00
W26 x D18.5 x H12cm



Bouli Rectangular Basket Lid
18014033 S\$5.30
W26 x D18.5 x H2cm



Bouli Square Basket
47027938 Medium S\$23.00
W35 x D37 x H16cm

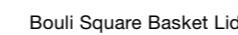

Bouli Square Basket Lid
18014019 S\$9.30
W35 x D37 x H2cm

*Can be used for M, L, XL Basket



Bouli Square Basket
18013999 Large S\$33.00
W35 x D37 x H24cm



Bouli Square Basket
47027945 Extra Large S\$36.00
W35 x D37 x H32cm



Rattan Rectangular Basket
47381290 Small S\$33.00
W36 x D26 x H12cm



Rattan Rectangular Basket Lid
15004768 S\$16.00
W36 x D26 x H3cm



Rattan Rectangular Basket
47381306 Medium S\$39.00
W36 x D26 x H16cm



Rattan Rectangular Basket
47381313 Large S\$49.00
W36 x D26 x H24cm



Rattan Laundry Basket With Lid
47405262 Large S\$79.00
W36 x D26 x H32cm



Rattan Rectangular Box
47381238 Small S\$33.00
W36 x D18 x H12cm



Rattan Rectangular Box With Lid
47381337 S\$36.00
W26 x D18 x H16cm



Rattan Rectangular Box With Handle
47028454 S\$23.00
W15 x D22 x H9cm



Rattan Square Basket
18021833 Medium S\$56.00
W35 x D36 x H18cm

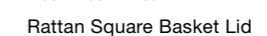

Rattan Square Basket
18021826 Large S\$79.00
W35 x D36 x H24cm

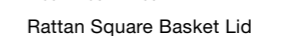

Rattan Square Basket Lid
15004775 S\$19.00
W35 x D36 x H3cm



Holds CDs



Holds DVDs



Holds A4 Documents



Storable on Stacking Shelf

Cleaning natural storage boxes: Avoid using at humid areas. Take it out under the sun regularly and clean it from dust using a vacuum or a brush.

Bac Bac, Cotton Linen Polyester Soft Box Storage

Bac Bac Storage baskets are made from hand-twisted Apaca rope (Manila hemp). The Cotton Linen Polyester Soft Box can be folded when not in use. These storage items comes in standard size for easy storing and stacking.

| Bac Bac Storage |



Bac Bac Rectangular Box
[76249221] With Lid S\$29.00
W26 x D18 x H16cm



Bac Bac Rectangular Basket With Lid
[76249207] Medium S\$46.00
W36 x D26 x H16cm



[76249214] Extra Large S\$56.00
W36 x D26 x H32cm



Example of Use

| Cotton Linen Polyester Soft Box Storage |



Cotton Linen Polyester Soft Box - Half Size
[15003501] Extra Small S\$11.00
W12 x D37 x H12cm
*DO NOT WASH



[15003518] Small S\$13.00
W26 x D18.5 x H16cm



When Folded



Example of Use



Cotton Linen Polyester Soft Box - Oblong
[18428847] Small S\$16.00
W37 x D26 x H16cm
*DO NOT WASH



[18428861] Medium S\$19.00
W37 x D26 x H26cm



[18428854] Medium With Lid S\$23.00
W37 x D26 x H26cm



[18428762] Large S\$23.00
W37 x D26 x H34cm



Cotton Linen Polyester Soft Box Square
[15003525] Small S\$19.00
1 [15003532] Small With Lid S\$23.00
W35 x D35 x H16cm
*DO NOT WASH



Cotton Linen Polyester Soft Box
[18285044] Large S\$23.00
2 [18285051] Large with Lid S\$33.00
W35 x D35 x H132cm
*DO NOT WASH



Cotton Linen Polyester Soft Box - Cloth Case
[18428779] Small S\$33.00
W59 x D39 x H18cm
*DO NOT WASH



[15003549] Large S\$36.00
W59 x D39 x H23cm



Storable on Stacking Shelf

Stainless Steel Wire Basket

Wire baskets made from the strong and rust-proof stainless steel. Designed with handles for easy carrying. Can be stacked over one another when the holders are tucked inside the basket.



18-8 Stainless Steel Wire Basket
[15117048] 2 S\$33.00
W37 x D26 x H8cm
Tolerable weight: 5kg
Allowed number of stacks: 2 stacks



[15117055] 3 S\$39.00
W37 x D26 x H12cm
Tolerable weight: 5kg
Allowed number of stacks: 2 stacks

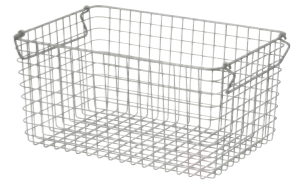

[15117062] 4 S\$43.00
W37 x D26 x H18cm
Tolerable weight: 5kg
Allowed number of stacks: 2 stacks

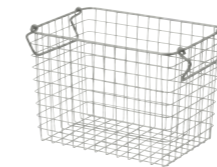

18-8 Stainless Steel Wire Basket
[15117031] 1 S\$29.00
W26 x D18 x H18cm
Tolerable weight: 5kg
Allowed number of stacks: 2 stacks



Example of Use



Holds A4 Documents



Acrylic Storage

Acrylic Storage Series allows easy identification of the contents stored. It is scratch resistant to maintain the beauty of the material. Available in a wide variety of shapes and sizes that fits your desk or even bathroom sink.



Acrylic Case With Drawer - 2 Rows
 47380910 Small S\$23.00
 W17.5 x D13 x H9.5cm
 Stackable with other similar sized acrylic storage items.



Acrylic Case With Drawer - 2 Rows
 47380934 Large S\$39.00
 W25.5 x D17 x H9.5cm
 Stackable with other similar sized acrylic storage items.



Acrylic Case With Drawer - 2 Rows
 47380965 Small S\$23.00
 W17.5 x D13 x H9.5cm
 Stackable with other similar sized acrylic storage items.



Acrylic Case With Drawer - 2 Rows
 47380989 Large S\$39.00
 W25.5 x D17 x H9.5cm
 Stackable with other similar sized acrylic storage items.



Velour Inner Case - Longitudinal
 47381009 S\$7.90
 W16 x D12 x H2.5cm
 Inner box for storing accessories and watches in the Acrylic Case With Drawer.
 *Two can be fitted into the large drawer.



Velour Inner Case - 15 Partitions
 47266825 S\$19.00
 W16 x D12 x H2.5cm
 Inner box for storing jewelry in the Acrylic Case With Drawer.
 *Two can be fitted into the large drawer.



Velour Inner Case - 6 Partitions
 47266887 S\$16.00
 W24 x D16 x H2.5cm
 Inner box for storing accessories and watches in the Acrylic Case With Drawer.
 *One can be fitted into the large drawer.



Velour Inner Case - Ring
 47266870 S\$16.00
 W24 x D16 x H2.5cm
 Inner box for storing jewelry in the Acrylic Case With Drawer.
 *One can be fitted into the large drawer.



Acrylic Glasses Stand
 61174280 S\$39.00
 W6.7 x D17.5 x H25cm
 Holds glasses and small items in four drawers. This storage item can be used upright or sideways.



Velour Inner Case
 61155036 S\$9.90
 W5 x D16.5 x H2.5cm
 *Exclusively for Acrylic Glasses Stand.



Acrylic Earrings & Necklace Stand
 18958207 S\$23.00
 W6.7 x D13 x H25cm
 Perfect for hanging earrings and necklace. Transparent storage stand for easy identification of the contents stored.



Velour Inner Case
 61155388 S\$9.90
 W5 x D12 x H2.5cm
 Inner box for storing rings.
 *Exclusively for Acrylic Earrings & Necklace Stand.



Acrylic Stand for Letter
 [15296224] W5 x D13 x H14.1cm **S\$9.00**
 A desktop stand convenient for storing envelopes and postcards.



Acrylic Stand - Deep
 [61407876] W17.5 x D13 x H9.5cm **S\$23.00**
 Stackable drawer-type acrylic case. Convenient for storing small cosmetic items and toiletries.



Acrylic Storage Stand
 [61798233] A5 **S\$23.00**
 Perfect for organizing the things on your desk. Suitable for storing A5 documents, notebooks and catalogues.



Acrylic Case
 [61485546] 3 Rows **S\$23.00**
 W26 x D17.5 x H10cm
 [15873128] 5 Rows **S\$39.00**
 W26 x D17.5 x H16cm



Acrylic Box - 3 Drawers
 [18076697] **S\$26.00**
 W13 x D8.8 x H14cm



Acrylic Box 3 Drawers
 [76475958] 3 Drawers **S\$49.00**
 [76476941] 6 Drawers **S\$59.00**
 Can be used upright or sideways by changing the arrangement of inner plates.



Acrylic Single Drawer Unit
 [61798196] W25.2 x D17 x H8.7cm **S\$29.00**
 Perfect for holding tiny miscellaneous items. Finished with high transparency acrylic material for easy identification of the contents stored.



Acrylic 3 Drawer Unit
 [61798202] W8.7 x D17 x H25.2cm **S\$39.00**
 Finished with high transparency acrylic material for easy identification of the contents stored. Combine with other acrylic storage items for extra storage space.



Acrylic Pen Stand
 [61479798] W5.5 x D4.5 x H9cm **S\$2.90**



Acrylic Pot
 [61479781] Small **S\$4.90**
 Dia8 x H11cm
 [61485584] With Lid **S\$5.90**
 Dia8 x H11.5cm



Acrylic Tissue Box
 [76226284] W26 x D13 x H7cm **S\$12.90**



Acrylic Stand with Partition - Half
 [61407869] Small **S\$9.90**
 W17.5 x D6.5 x H4.8cm
 [61407852] Large **S\$13.90**
 W17.5 x D6.5 x H9.5cm
 Stackable acrylic case perfect for storing small cosmetic items and toiletries.



Acrylic Stand with Partition - Clear
 [61407838] W17.5 x D13 x H9.5cm **S\$19.00**
 Stackable with other similar sized acrylic storage items.



Acrylic Stand with Partition - Half
 [61407845] Large **S\$29.00**
 W25.8 x D17.5 x H6.1cm
 Stackable acrylic case perfect for storing small cosmetic items and toiletries. Internal dividers can be removed to create more storage space.



Acrylic Pen Stand
 [15296231] Small **S\$11.90**
 W8.8 x D8.8 x H9.5cm
 [15296248] Large **S\$16.00**
 W13 x D8.8 x H9.5cm



Acrylic Rack
 [15296286] Small **S\$19.00**
 W8.8 x D13 x H14.2cm
 [15296309] Large **S\$29.00**
 W17.5 x D13 x H14.2cm



Acrylic Partition Shelf
 [15919833] Small **S\$9.60**
 W26 x D17.5 x H10cm
 [15919840] Large **S\$13.00**
 W26 x D17.5 x H16cm



Acrylic Collect Box
 [61703671] 4x4 **S\$49.00**
 W27.5 x D7.2 x H34.7cm
 Uses non-transparent rear panel for better presentation of items.
 Contents can be taken in and out from both front and back.



Acrylic CD Stack Rack
 [76226277] **S\$23.00**
 W13.5 x D27 x H15.5cm
 Stackable CD rack. Holds about 25 CDs.



Acrylic CD Rack - Box Type
 [76226253] **S\$19.00**
 W17.5 x D13 x H14cm
 Stackable CD box. Holds about 16 CDs.

| MDF Small Storage |

MDF accessory storage finished in size perfect for storing the items on your desk.



MDF Drawer
 [76617969] 6 Tier **S\$59.00**
 W8.4 x D17 x H25.2cm
 [76617952] 3 Tier **S\$49.00**
 W8.4 x D17 x H25.2cm
 MDF, Sliced ash wood veneer, Lacquer-finished Finished with an ash wood surface, easy to match interior décor. Usable both upright and sideways by changing the arrangement of drawers.



MDF Single Drawer Unit
 [76617945] **S\$39.00**
 W25.2 x D17 x H8.4cm
 A size perfect for organizing the things on your desk. Comes with one piece of inner divider for partitioning.



MDF Storage Stand
 [61798066] A5 **S\$26.00**
 W8.4 x D17 x H25.2cm
 MDF, Sliced ash wood veneer, Lacquer-finished Finished with an ash wood surface, easy to match interior décor. A size perfect for organizing the things on your desk.



MDF Document Tray
 [76316510] A4 **S\$39.00**
 W32x D24 x H10.5cm
 MDF, Sliced ash wood veneer, Lacquer-finished Finished with an ash wood surface, easy to match interior décor. A size perfect for organizing the things on your desk.

Study Desk Working Chair

Make your own desk by combining your choice of top board and legs. Simple yet durable, this product can be used for various applications. Optional parts are available for your customization.



Oak Desk with Drawers

15874781
W110 x D55 x H70cm

S\$399.00



Oak Desk Cabinet

15874804
W35 x D48 x H56cm

S\$239.00



Desk Top Panel - Ash

61394572
W150 x D60 x Thk2cm

S\$229.00

61394565
W120 x D60 x Thk2cm

S\$199.00



Desk Top Panel - Melamine White

61394541
W150 x D60 x Thk2cm

S\$229.00

61394534
W120 x D60 x Thk2cm

S\$199.00



Desk Steel Legs

15914555
W150 x D60 x H72cm

S\$139.00

15914562
W120 x D60 x H72cm

S\$119.00

| Optional Parts |



Steel Cabinet - Light Grey

18121236
W39.5 x D56 x H62.5cm

S\$339.00



Designed with rounded corners for safety with the intention of minimizing the pain if you hit against it.

The back board of the top and middle drawers are made higher to prevent things kept in the drawers from falling.

The bottom drawer is designed to be able to be pulled out to the end of its back board.



Working Chair

18121298 Light Grey

S\$209.00

18121304 Black

S\$209.00

W55.5 x D73 x H74~84cm (Seat Height 39~49cm)



When the arm is attached



More Backward Arm Position

Arms were positioned more backward for easy elbow resting during relax time.



Lower Seat Height

Seat height is made lower for the users that are small in size and users who do not wear shoes in the room.



Sophisticated Rear View

Bolts on the back rest are made invisible for a more sophisticated appearance.



Round Finished Legs

Legs are finished with a roundish shape to avoid hurting the bare foot of the user.

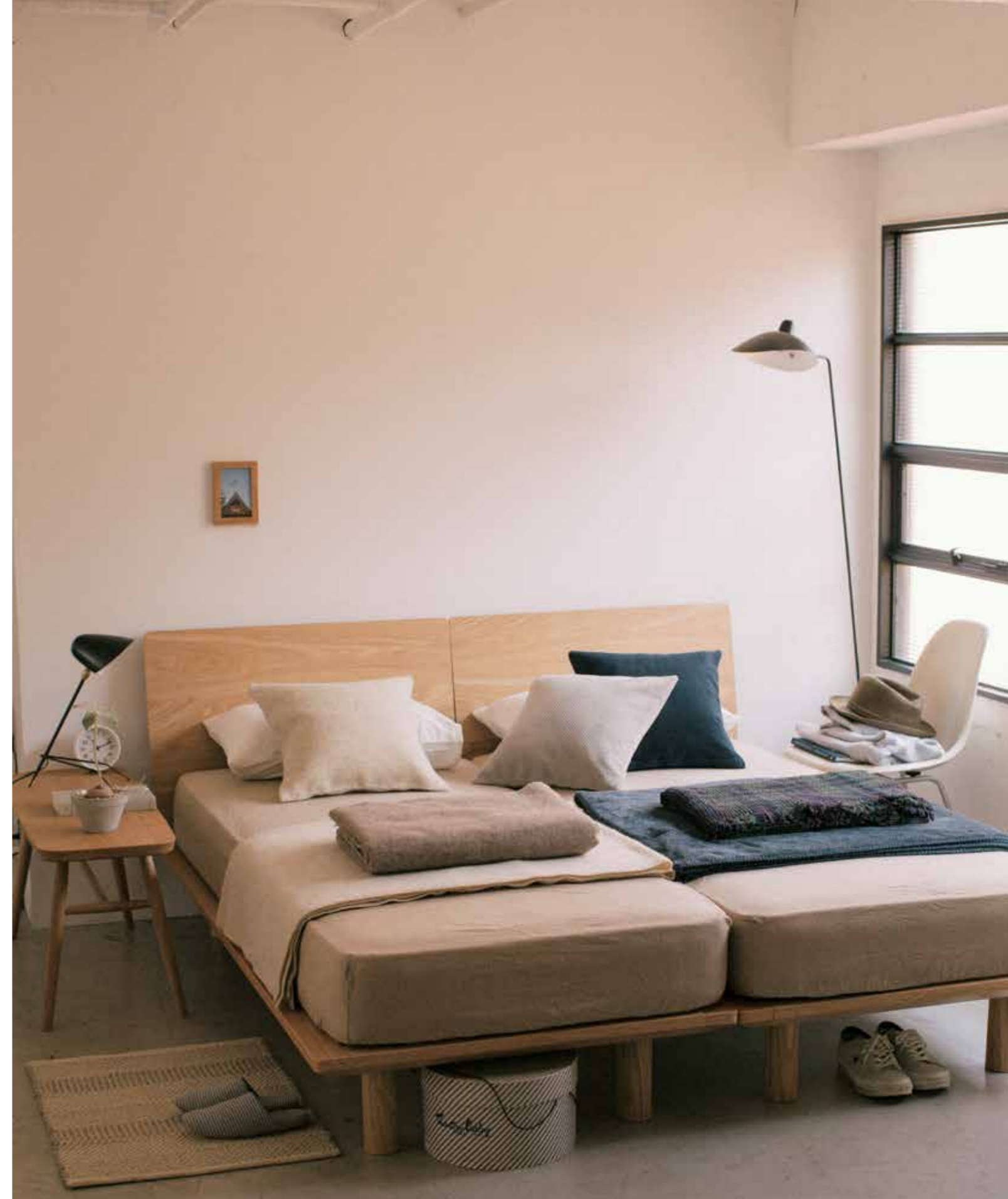

Bedding

Wooden Bed Frame

A simple bed with a thin frame that makes the room look bigger. You can add a headboard or storage baskets under the bed according to your preference.



*Combination example: Mattress is sold separately.



*Combination example: Mattress is sold separately.

Wooden Bed Frame

1	37285453	Oak / Single	S\$469.00
		W103 x D202 x H25.5cm	
	37285477	Oak / Double	S\$629.00
		W147 x D202 x H25.5cm	
3	37285491	Walnut / Single	S\$549.00
		W103 x D202 x H25.5cm	
	37285514	Walnut / Double	S\$709.00
		W147 x D202 x H25.5cm	



Wooden Bed Headboard

2	37285538	Oak / Single	S\$189.00
		W103 x D8 x H53cm	
	37285552	Oak / Double	S\$289.00
		W147 x D8 x H53cm	
	37285583	Walnut / Single	S\$239.00
		W103 x D8 x H53cm	
	37285606	Walnut / Double	S\$339.00
		W147 x D8 x H53cm	



Choose your own bed base

There are many features we want to have for our bed simply because we spend a lot of time on it. Some of us want to have 2 single beds side-by-side or beds with spacious storage; beds with a more rounded design or beds with good ventilation. The list is endless.

This MUJI wooden bed is a bed designed in answer to these desires. The wooden springs of this bed come with belts to adjust the bedstead to the desired hardness or softness. The headboard and the wooden under-bed storage drawers have also been designed for effective space usage when 2 single beds are joined side-by-side.

MUJI's aim is to create a bed that is comfortable to sleep on and practical in daily living.

1. Headboard

The reclined headboard has been designed for a more relaxing posture when leaned against while doing some reading or writing before bedtime – the other way to enjoy this bed.

2. Wooden Springs

The wooden springs are given some sort of flexibility too. This doubles the effect of the mattress, minimizing the body weight distribution to the back and hip.

3. Base Legs

The base legs can be dismantled for those who prefer to have their bed frame lie flat on the floor instead.

4. Storage

The spacious wooden under-bed storage drawers can be a great tool to effectively use the space under the bed. These wooden storage drawers can be used to keep large fabrics such as blankets or compartmentalized to keep frequently used smaller items.

5. Mattress

Choose from the 3 types of mattresses available that suit your preferences.



Wooden Bed Storage Box - Large

4	37285620	Oak	S\$189.00
	37285637	Walnut	S\$229.00
		W80 x D90.5 x H19cm	



Wooden Bed Storage Box

5	37285644	Oak	S\$159.00
	37286139	Walnut	S\$189.00
		W80 x D60.5 x H19cm	



Pocket For Wooden Bed

6	61048970		S\$33.00
		W29 x H26.5cm	





Oak Bed

A basic bed made from durable and sturdy laminated solid wood that can be used for a long period of time.



*Combination example: Mattress is sold separately.

Oak Bed

[37285248] Single W100 x D202 x H74cm	S\$629.00
[37285279] Queen W60 x D202 x H74cm	S\$1199.00
[37285286] King W103 x D202 x H25.5cm	S\$1399.00



It is designed at an slant angle for our body to lean comfortably against it. The bed frame is also wider and thicker to increase stability.



It is broad enough to place alarm clock and other small things.

Storage Bed

A bed with an under-bed storage equivalent to the storage of 2 units of 4-tier wide chest drawers. Suitable to store everyday clothing or even larger items such as suitcases or futon mattresses.



Additional Box
With wooden spring base removed.
*There is no base board under the open space as shown.

[Storage Area] Double Bed

4 Tier Wide Chest with storage power of 2 combined units.

For a more effective storage in rooms, we have relooked into under-bed storage designs. Using storage box itself to support the mattress, more storage space is now available.



*Combination example: Mattress is sold separately.

Storage Bed - Oak

[15238217] / Single	S\$499.00
W105.5 x D201 x H27cm	
[15056729] / [15057016] Double	S\$619.00
W148.5 x D201 x H27cm	



Storage Bed - Walnut

[15238293] / Single	S\$599.00
W105.5 x D201 x H27cm	
[15238316] / Double	S\$699.00
W148.5 x D201 x H27cm	



Storage Bed Additional Box - Oak

[76359920] Single	S\$96.00
W105.5 x D15 x H27cm	
[76359944] Double	S\$129.00
W148.5 x D15 x H27cm	



Storage Bed Additional Box - Walnut

[76359951] Single	S\$109.00
W105.5 x D15 x H27cm	
[76359975] Double	S\$149.00
W148.5 x D15 x H27cm	



Bonnell Coil Mattress

The mattress focuses on the inner layer such as spring coils. Bed pads are washable to maintain cleanliness. Available in various types.



Muji refocuses on the structure of the mattress that is defined for a greater comfort and body support as desired. The frame material is now changed from wood to steel in order to enhance breathability and durability. Now, removing the cover is simple; thus makes washing easy for a longer period of usage.

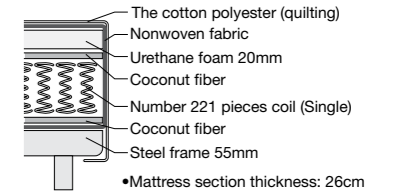

Simple Classic Bed

1. Cover

Changing the cover is simple. With periodic washing, the cover can be kept clean. The cover can be removed and machine-washed.

2. Spring Unit

MUJI mattress uses bonnell coils. It is covered in non-woven fabric so the unit can be changed easily when necessary.

3. Steel Frame

The strength of the mattress is reinforced by changing the frame from wood to steel.

4. Wooden Legs in Natural Wood

Choose from two different heights to suit your preference.

Height: 20cm / 26cm



Mattress - Single

[15831128]	S\$259.00
W98 x D198 x H26cm	

Legs for Mattress - Set of 4pcs

[47462203] H20cm	S\$33.00
[15296972] H26cm	S\$39.00

Mattress (Single) + With Legs (H20cm)

S\$292.00

Mattress (Single) + With Legs (H26cm)

S\$298.00

| Solid Oak Series |

Featuring hardness, solidness and durability, oak is the ideal material for a furniture that will be used for a long period of time. The texture of oak also becomes more attractive over time.



*Combination example: Mattress is sold separately.

Oak Solid Wood Bed

• [15890835] Single	S\$799.00
W105 x D202 x H75cm	
[15892174] Queen	S\$1299.00
W168 x D202 x H75cm	
• Only for Special Order.	



Example of Use With Storage Box

Mattress, Bed Pad

The use of urethane foam is minimized as much as possible so that a comfortable sleep induced from the use of spring coils can be maximized. Add on a washable bed pad to maintain cleanliness.



More spring coils, higher stability for a good sleep posture.

Increasing the number of coils disperses the body pressures. It also suppresses the load to the backbone and hip. As coils move in synchrony with the unevenness of the body, the coils can support the body in good balance and maintain a longer stable body posture.

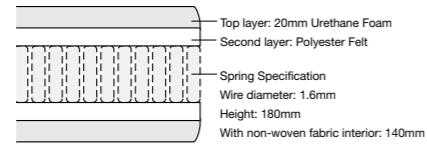

High Density Pocket Coil Mattress

[15783724] Single	S\$899.00
W97 x D195 x H19cm	
[15783748] Double	S\$1299.00
W140 x D195 x H19cm	
[15783755] Queen	S\$1599.00
W160 x D195 x H19cm	



Stand-alone coils provide point-support to the body.

The many stand-alone coils are closely positioned to one another to create a mechanism that absorbs the body weight on each of its point. This links to a balanced support to the entire body. It maintains a stable posture of the body and prevents the wobbling or indents on the mattress.

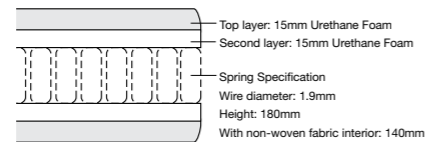

Pocket Coil Mattress

[18094844] Single	S\$499.00
W97 x D195 x H19cm	
[18094868] Double	S\$899.00
W140 x D195 x H19cm	
[61863351] Queen	S\$1099.00
W160 x D195 x H19cm	



The high resilience provides a steady support to the body.

Drum-shaped coils are joined together so that the entire mattress surface firmly supports the body pressure. This product uses Bonnel coil springs which are currently the most popular and reliable with proven performance and excellent resiliency.

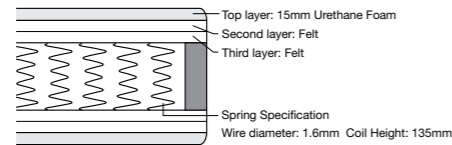

Spring Mattress

[15901838] Single	S\$239.00
W97 x D195 x H18cm	
[15901852] Double	S\$399.00
W140 x D195 x H18cm	



Bed Pad With Elastic Rubber
 [18988877] Queen S\$139.00
 W160 x L200cm
 Fabric: 50% Cotton, 50% Polyester
 Filling: 100% Wool



Antibacterial Washable Bed Pad With Elastic Rubber
 [18557325] Single S\$49.00
 W100 x L200cm
 [18557349] Double S\$69.00
 W140 x D195 x H18cm
 Fabric: 55% Cotton, 45% Polyester
 Filling: 50% Cotton, 50% Polyester



Example of Use

Futon, Pillow

For sleeping comfort, our bedding has been developed to focus on materiality and functionality. Select your ideal bedding from our wide range of variety.



Body Pressure Dispersion Futon

[15000739] Single S\$399.00
 W100 x L200cm
 Fabric: Front - 65% Polyester, 35% Cotton; Back - 100% Polyester
 Padding: Urethane Foam
 *Do not wash



Polyester Hard Mattress For Futon

[18387403] Single S\$93.00
 W95 x D210 x H4cm
 Fabric: 50% Polyester, 50% Cotton
 Filling: 100% Polyester
 *Do not wash



Wool Polyester Quilted Futon

[37107854] Single S\$189.00
 W100 x L210cm
 Fabric: 100% Cotton
 Filling: 50% Wool, 50% Polyester
 Solid Cotton: 100% Polyester



Feather Pillow

[15828494] S\$19.00
 43 x 63cm
 [15808500] S\$23.00
 50 x 70cm
 Made with lightweight feathers, the pillow feels soft and does not sink easily providing comfort for a good sleep.



Urethane Foam Low Repulsion Pillow

[15001910] S\$33.00
 43 x 63cm
 This pillow is made from low and high repulsion urethane which provides extreme comfort on your neck and head.



Urethane Foam Low Repulsion Molded Pillow

[15828524] S\$79.00
 43 x 63cm
 Uses low repulsion urethane mould which exerts a small change in its hardness caused by the change of temperature. Features extreme comfort for your neck and head.

*Regularly let the mattress stand off the floor to ventilate it. Leaving the mattress over a long period on the floor may cause the formation of moulds.



Sofa

Living Dining Table & Chair

Embracing the unity of the two spaces catering to relaxation, dining or both. With the right furniture, a living and dining area can live beautifully within the same walls.



- Living Dining Table**
- 1 [15253845] Table 1 / Depth 65cm W150 x D65 x H60cm S\$649.00
 - 2 [15253852] Table 2 / Depth 65cm W130 x D65 x H60cm S\$569.00
 - 3 [15253881] Table 3 / Depth 80cm W150 x D80 x H60cm S\$889.00
- Only for Special Order.
-



- Living Dining Bench**
- 3 [15257058] Bench 1 W115 x D46 x H40.5cm S\$399.00
 - 4 [15257065] Bench 2 W58 x D46 x H40.5cm S\$239.00
-



- Living Dining Sofa Chair**
- [15253722] Chair W55 x D78 x H77cm S\$399.00
 - 6 [15549597] Connecting Plate / Set of 2 pieces S\$16.00
 - 5 [15253739] Arm Set Set of 2 pieces S\$49.00
-



- Oak AV Rack Flat Type With Sliding Door**
- 7 [37153660] AV Rack 1 W150 x D35 x H36.5cm S\$549.00
 - 8 [37153653] AV Rack 2 W110 x D35 x H36.5cm S\$469.00



*All covers sold separately. Kindly refer to page 47 for cover selection.



Wide Arm Sofa

Comfort at its own. Choose the cushion type, the colour of the legs and the combination of the cover that matches your home.

| Feather Pocket Coil Cushion |

The sofa is a coupled-effect of the soft feather cushioning and the assuring stability of the pocket coils.



Sofa Body - 2.5 Seater

[47276992]
W190 x D87.5 x H75cm

S\$899.00



The feather and pocket coil combination sofa sort of wraps one's body when sat on. The back rest has a soft feather cushiony feel while the sofa seat itself has a sturdy and soft coil-feather feel. A design made for relaxation.



Back rest: Urethane + Feather



Seat: Pocket Coil + Feather

| Urethane Foam Cushion |

A slightly sturdy sofa that eases the movement of getting up and seating. The cushion softens up to the body after frequent use.



Sofa Body - 2.5 Seater

[47276985]
W190 x D87.5 x H75cm

S\$699.00



A combination of a very sturdy seat and urethane cushion, this sofa uses a just-right urethane hardness to create the needed stability for seating. The sturdy urethane back rest and seat is not too soft which provides a great support to the body.



Back rest: Urethane



Seat: Urethane



Ottoman

[47276916]
W54.5 x D35 x H35cm

S\$129.00



| Additional Parts |

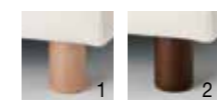

Legs for Sofa / Ottoman

1	[47277029] Natural	S\$33.00
2	[47277036] Brown	S\$33.00
	H10cm	

*All covers sold separately. Kindly refer to page 47 for cover selection.

Unit Sofa

MUJI Unit Sofa Series is now available in two sizes. Freely arrange the unit sofas in a position that suits your living space and lifestyle. Made with urethane foam, this sofa range assures good seating comfort.



With Armrest

[15815159] Large
W95 x D82 x H66cm
S\$489.00

[15815180] Small
W82 x D82 x H66cm
S\$399.00



Armless

[15815166] Large
W74 x D82 x H66cm
S\$399.00

[15815197] Small
W61 x D82 x H66cm
S\$319.00



Ottoman

[15815173] Large
W74 x D61 x H37cm
S\$319.00

[15815203] Small
W61 x D61 x H37cm
S\$289.00



Box

[76580577] Shelf
W75 x D32 x H41cm
S\$239.00

[76580584] Table
W59 x D75 x H32cm
S\$319.00

Sofa Chair Cover

Pick a cover that best suits your home. Choose from the different colours and materials in the selection below.

Cover		Cotton	Cotton Polyester		Cotton Chenille		
		Dark Brown	Beige	Brown	Light Grey	Green	Charcoal Grey
Wide Arm Sofa	2.5 Seater	[15999118] S\$259.00	[18022182] S\$389.00	[18022168] S\$389.00	[61048499] S\$389.00	[61048369] S\$389.00	[61048239] S\$389.00
	Ottoman	[15999163] S\$49.00	[18022069] S\$63.00	[18022052] S\$63.00	[61048543] S\$63.00	[61048413] S\$63.00	[61048284] S\$63.00
Unit Sofa	With Armrest L		[15435777] S\$239.00	[15439072] S\$239.00	[15449118] S\$239.00	[15453351] S\$239.00	
	With Armrest S		[15435807] S\$209.00	[15439102] S\$209.00	[15449149] S\$209.00	[15454303] S\$209.00	
	Armless L		[15435784] S\$209.00	[15439089] S\$209.00	[15449125] S\$209.00	[15454280] S\$209.00	
	Armless S		[15435814] S\$179.00	[15439119] S\$179.00	[15449156] S\$179.00	[15454464] S\$179.00	
	Ottoman L		[15435791] S\$179.00	[15439096] S\$179.00	[15449132] S\$179.00	[15454297] S\$179.00	
	Ottoman S		[15435821] S\$129.00	[15439126] S\$129.00	[15449163] S\$129.00	[15454532] S\$129.00	
Living Dining Series	Sofa Chair		[15435845] S\$99.00	[37610873] S\$99.00	[15256471] S\$99.00	[15256488] S\$99.00	
	Bench 1		[15435852] S\$79.00	[37610897] S\$79.00	[15257096] S\$79.00	[15257102] S\$79.00	
	Bench 2		[15436705] S\$49.00	[37610910] S\$49.00	[15257133] S\$49.00	[15257140] S\$49.00	
Highback Reclining Sofa	1 Seater		[37155411] S\$309.00	[37155428] S\$309.00			
	2 Seater		[37157309] S\$449.00	[37157392] S\$449.00			
	Ottoman		[37158207] S\$79.00	[37158214] S\$79.00			

• Only for Special Order.

*All covers sold separately. Kindly refer to page 47 for cover selection.



Sofa Bench Series

Made with steel frame for added durability. It has been designed to suit different lifestyles. Sit in comfort, lie down to relax, have your meal or even use it for gatherings.



Pair Sofa Bench with Ottoman or Side Table (sold separately) to arrange in the way you like.

Sofa Bench

37146761
W180 x D90 x H60.5cm
*comes with legs in black colour.

S\$1099.00



Cover for Sofa Bench

37244856
Grey Beige (base) x Brown (back)

S\$229.00

Sofa Bench - Ottoman

37146778
W60 x D60 x H40.5cm
*comes with legs in black colour.

S\$239.00



Cover for Ottoman

37244825
Grey Beige

S\$79.00



Sofa Bench - Table

37148765
W60 x D60 x H37cm

S\$309.00



Enjoy Freestyle Arrangements

Sit with style at your comfort.



Lie down and Relax.



Gather with your friends & families.



Beads Cushion

Flexible sofa that freely moulds its shape to your sitting preference with ultra micro beads and stretchable cover that wraps your body in comfort.



Beads Cushion	
61049182	S\$169.00
W65 x D65 x H43cm	
Beads Cushion Cover	
1 61048888	Grey Beige S\$49.00
2 61048871	Dark Brown S\$49.00
3 76580294	Navy S\$49.00
4 37137516	Coral Pink S\$49.00
5 37137509	Ash Grey S\$49.00
6 37137493	Corn Yellow S\$49.00
W65 x D65 x H43cm	



Ultra micro beads of approximately 0.5mm are resistant to deformation which provides an extra soft sitting comfort.

When placed on its side

Wraps your body from waist till neck and keeps you in your favourite posture. Ideal for reading and watching television.

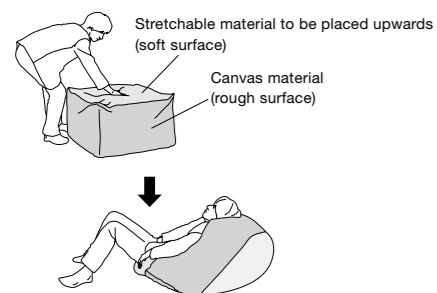

When placed upright

Sinks and widens in all directions making it comfortable when resting.

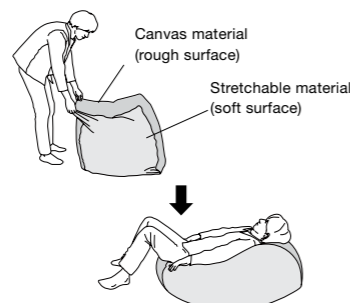

Reclining Sofa

MUJI's reclining sofa has been designed to achieve that relaxed reclining comfort that you need.



Highback Reclining Sofa - 2 Seater
1 37153608 S\$809.00
W148 x D100 x H93cm

Highback Reclining Sofa - 1 Seater
2 37153592 S\$489.00
W74 x D100 x H93cm

Highback Reclining Sofa - Ottoman
3 37153615 S\$209.00
W68.5 x D43 x H38cm



Highback Reclining Sofa (Cover) - 2 Seater	
4 37156784	Cotton Beige S\$359.00
5 37156913	Cotton Dark Brown S\$359.00
6 37157309	Cotton Polyester Beige S\$449.00
7 37157392	Cotton Polyester Brown S\$449.00

Highback Reclining Sofa (Cover) - 1 Seater	
4 37154681	Cotton Beige S\$239.00
5 37154698	Cotton Dark Brown S\$239.00
6 37155411	Cotton Polyester Beige S\$309.00
7 37155428	Cotton Polyester Brown S\$309.00

Highback Reclining Sofa (Cover) - Ottoman	
4 37158061	Cotton Beige S\$49.00
5 37158122	Cotton Dark Brown S\$49.00
6 37158207	Cotton Polyester Beige S\$79.00
7 37158214	Cotton Polyester Brown S\$79.00

High back design offering greater support up to the head

The high back design allows you to lie back and relax on the sofa. The cushions gently support your body right up to the neck position.

With reclining function

The reclining function of this chair is for both the backrest and the headrest, which allows you to adjust the sofa to your desired angle. The backrest is adjustable to six positions by the lever; and the headrest can be adjusted to six positions, even when the sofa is laid flat.



With reclining function

The cushions are made with soft and fluffy feathers to provide an exceptional sitting comfort. Urethane chips are mixed with feathers to enhance cushion resilience. The cover is detachable from the cushion body. If wrinkles are observed on the sofa surface, remove the cover and knead the cushion to puff it up.





Wood Tables and Chairs

Enjoy every meal and tea-time. The joy in our everyday life begins when we gather around the table.



Oak Extension Table
 [15877553] **S\$799.00**
 W140-190 x D80 x H72cm
 Tolerable weight: 40kg, extension plate: 10kg



Oak Bench
 [15892419] **S\$309.00**
 W100 x D37 x H44cm
 Tolerable weight: Middle shelf 10kg



Oak Side Table Bench
 [15892341] **S\$159.00**
 W37 x D37 x H44cm
 Tolerable weight: 15kg



Oak Table 180cm
 [15892402] **S\$1199.00**
 W180 x D80 x H72cm
 Tolerable weight: 40kg



Oak Table 140cm
 [15892396] **S\$939.00**
 W140 x D80 x H72cm
 Tolerable weight: 40kg



Pinewood Foldable Table
 [18499441] High **S\$83.00**
 W80 x D50 x H70cm
 [18499434] Low **S\$73.00**
 W80 x D50 x H35cm
 Tolerable weight: 15kg



When Folded Back



Oak Solid Wood Table Bench
 [15892426] **S\$739.00**
 W120 x D37.5 x H44cm
 Tolerable weight: Storage 20kg



Example of Use



Oak Solid Wood Bench
 4 [15892358] Large **S\$189.00**
 W100 x D30 x H44cm
 5 [15892365] Small **S\$159.00**
 W45 x D30 x H44cm



Oak Chair With Beige Seat
 [15892372] Natural **S\$249.00**
 W38 x D48.5 x H79cm
 (P)

Low Table

Use this U-Shape furniture as an informal table that can be used throughout the year as a low table. Now available in square, rectangular and even oblong designs.



Ash Plywood Oval Table

[47549256]	W140cm	S\$599.00
W140 x D79 x H35cm		
1 [47549263]	W110cm	S\$499.00
W110 x D62 x H35cm		
Tolerable weight: 40kg		



Oak Low Table

[15880850]	W120 x D60 x H35cm	S\$569.00
W120 x D60 x H35cm		
2 [15880843]	W90 x D60 x H35cm	S\$469.00
W90 x D60 x H35cm		
[15880836]	W90 x D45 x H35cm	S\$399.00
W90 x D45 x H35cm		
Tolerable weight: 40kg, 5kg per drawer		



With Cover

Side

Without Cover

Legless Chair (Body) - Large

[18481286]	S\$79.00
W57 x D102 x H10cm	

Legless Chair (Body) - Small

[18481293]	S\$59.00
W46 x D86 x H10cm	

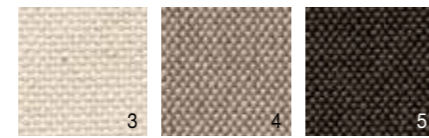

Legless Chair (Cover) - Large

3 [76936954]	Canvas Ecru	S\$39.00
4 [15999057]	Cotton Beige	S\$43.00
5 [15999699]	Cotton Brown	S\$43.00

Legless Chair (Cover) - Small

3 [76936961]	Canvas Ecru	S\$29.00
4 [15999064]	Cotton Beige	S\$33.00
5 [15999705]	Cotton Brown	S\$33.00



Ash Multi-Purpose U-Shape - W70cm

[18121656]	Natural	S\$139.00
[18121670]	Brown	S\$139.00
W70 x D30 x H35cm		
Tolerable weight: 40kg when used as a shelf		



Ash Multi-Purpose U-Shape - W35cm

[18121663]	Natural	S\$109.00
[18121687]	Brown	S\$109.00
W35 x D30 x H35cm		
Tolerable weight: 40kg when used as a shelf		



| Beech Wood Series |

Muji uses high quality beechwood from Europe. Since the pressing of beech requires easy strength, it has been a popular furniture material for a long time in Europe.



When Folded

Beech Folding Chair Wooden Seat Plywood

[87167117]	S\$99.00
W45.5 x D52.5 x H79.5cm	

Beech Low Table Round

[15902217]	S\$209.00
W459.5 x D59.5 x H35cm	



Beech Compact Table

[15120109]	S\$289.00
W75 x D40 x H70 cm	



HOME DELIVERY

* With effect from July 2015

Delivery Time	Delivery charges for purchases below S\$500	Delivery charges for purchases above S\$500
Monday - Friday		
10:00am - 7:00pm	S\$40	Free
7:00pm - 9:00pm	S\$60	S\$20
Saturday		
10:00am - 7:00pm	S\$60	S\$20

No deliveries on Sunday and Public Holidays.
Labour charge for walk-up apartment is at S\$10 per level.
Delivery service is based on single destination within Singapore only.

No assembly charges will be required on the first delivery, for subsequent request, assembly charge of \$8 per item will be applicable.

Stock availability and delivery charges vary for online and in-store. Kindly visit our webpage (www.muji.com/sg/store) for more information.

Please approach our staff for further enquiries.

MUJI (SINGAPORE) Pte Ltd reserves the right to amend the above Terms & Conditions without prior notice.