



## 2016 Furniture Catalogue



**MUJI**  
無印良品

[www.muji.com/sg/](http://www.muji.com/sg/)  
[www.facebook.com/muji.sg](https://www.facebook.com/muji.sg)

313@somerset	#B2-38 to 41 & 47 to 49	Tel: 6634 5053
Bugis Junction	#03-10F	Tel: 6336 7885
ION Orchard	#B4-16	Tel: 6509 9321
Jem	#04-33 to 37	Tel: 6339 2558
Marina Square	#02-326 to 330	Tel: 6336 6123
Paragon Orchard	#04-36 to 40	Tel: 6735 0123
Raffles City	#02-20/22	Tel: 6264 4189
Tampines 1	#03-07	Tel: 6509 9733
VivoCity	#02-198	Tel: 6376 8023

2016 © MUJI (Singapore) Pte. Ltd. All product and price information are correct as of print, and may be subject to change. Any dimensions quoted are for guidance only. All products are subject to availability. Refer to in-store display for latest updated pricing. All Rights Reserved. Published July 2016.



**MUJI**  
無印良品



# 2016 Furniture Catalogue

<b>Storage</b>	<b>6</b>	Storage Furniture	7
		Storage Items	23
		Desk Storage	36
<b>Bedding</b>	<b>43</b>	Bed	44
		Mattress, Bed Pad	50
		Futon, Pillow	51
<b>Sofa</b>	<b>52</b>	Living Dining Chair	53
		Wide Arm Sofa	54
		Unit Sofa	56
		Beads Cushion	58
		Reclining Sofa	59
<b>Tables &amp; Chairs</b>	<b>60</b>	Wood Furniture	61
		Low Table	62
		Beech Wood Series	62

## Pictorial Indicator Used In Catalog



Prefabrication Unit +  
Assembly Time (min)



Can be  
assembled alone



To be assembled by  
two or more persons



Product with optional  
parts sold separately



Requires Phillips  
Screw Driver

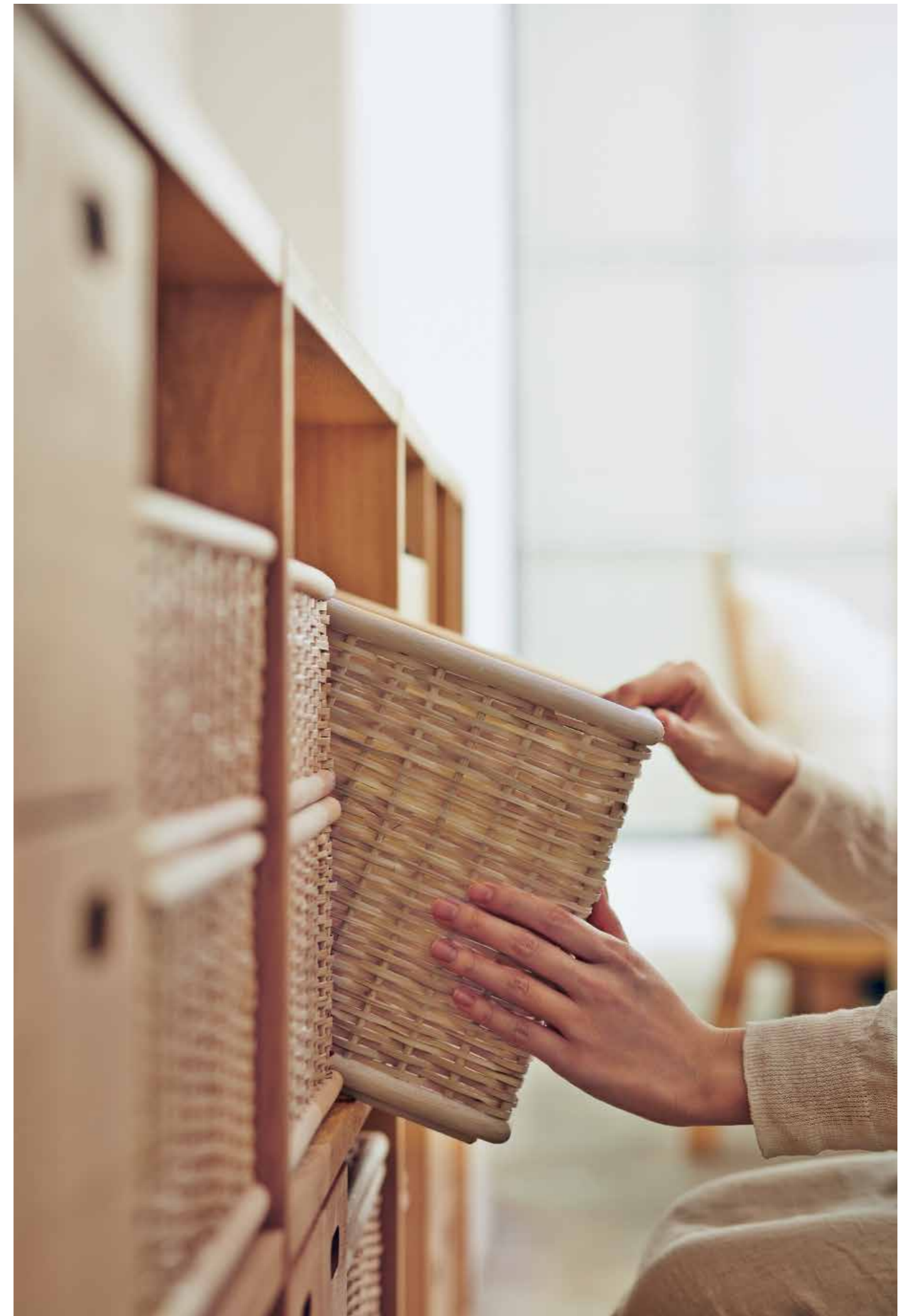



## Stacking Shelf

A shelf which can be extended both vertically and horizontally to suit various needs. As this shelf does not have a rear panel, it can be used as a bookshelf, a decorative shelf, or even as a room dividing shelf. A wide type is also available to suit different applications.

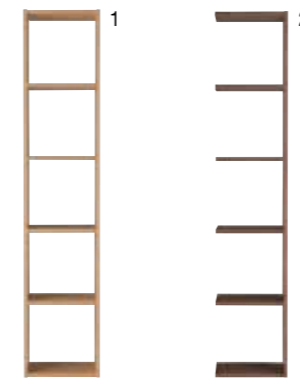

Stacking Shelf 5 Row Base

1	37263178	Oak	S\$309.00
	37265646	Walnut	S\$339.00
W42 x D28.5 x H200cm			

Stacking Shelf 5 Row Add On

	37263208	Oak	S\$279.00
2	37265677	Walnut	S\$309.00
W40 x D28.5 x H200cm			

Tolerable weight: 20kg per shelf, overall shelf 60kg

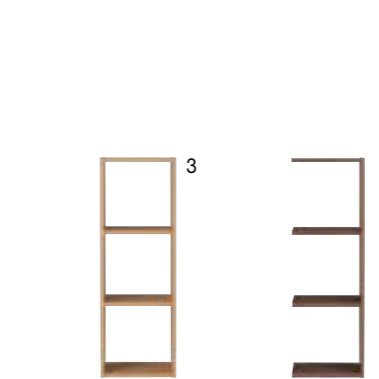

Stacking Shelf 3 Row Base

3	37263161	Oak	S\$239.00
	37265639	Walnut	S\$279.00
W42 x D28.5 x H121cm			

Stacking Shelf 3 Row Add On

	37263192	Oak	S\$229.00
4	37265660	Walnut	S\$259.00
W40 x D28.5 x H121cm			

Tolerable weight: 20kg per shelf, overall shelf 40kg

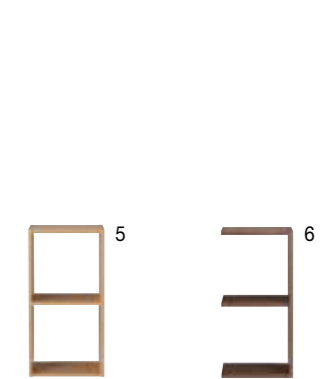

Stacking Shelf 2 Row Base

5	37263154	Oak	S\$199.00
	37265622	Walnut	S\$229.00
W42 x D28.5 x H81.5cm			

Stacking Shelf 2 Row Add On

	37263185	Oak	S\$179.00
6	37265653	Walnut	S\$209.00
W40 x D28.5 x H81.5cm			

Tolerable weight: 20kg per shelf, overall shelf 30kg

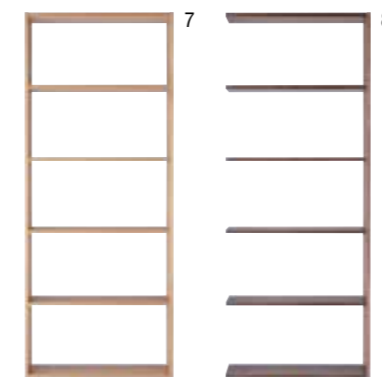

Stacking Shelf 5 Wide Base

7	37263239	Oak	S\$399.00
	37265707	Walnut	S\$439.00
W81.5 x D28.5 x H200cm			

Stacking Shelf 5 Row Wide Add On

	37263260	Oak	S\$369.00
8	37265738	Walnut	S\$399.00
W79.5 x D28.5 x H200cm			

Tolerable weight: 20kg per shelf, overall shelf 60kg

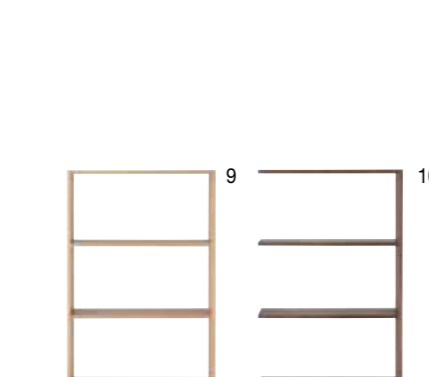

Stacking Shelf 3 Wide Base

9	37263222	Oak	S\$329.00
	37265691	Walnut	S\$359.00
W81.5 x D28.5 x H121cm			

Stacking Shelf 3 Row Wide Add On

	37263253	Oak	S\$309.00
10	37265721	Walnut	S\$339.00
W79.5 x D28.5 x H121cm			

Tolerable weight: 20kg per shelf, overall shelf 40kg

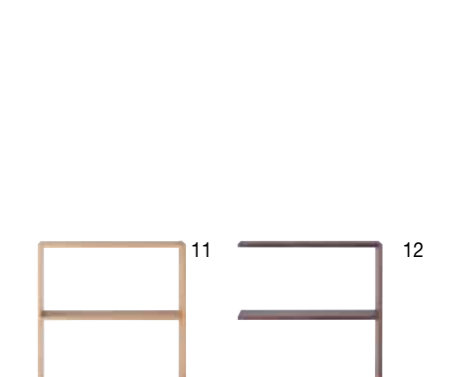

Stacking Shelf 2 Row Wide Base

11	37263215	Oak	S\$279.00
	37265684	Walnut	S\$309.00
W81.5 x D28.5 x H81.5cm			

Stacking Shelf 2 Row Add On

	37263246	Oak	S\$259.00
12	37265714	Walnut	S\$289.00
W79.5 x D28.5 x H81.5cm			

Tolerable weight: 20kg per shelf, overall shelf 30kg



# Storage Furniture



**Stacking Shelf 5R3L Add On**  
 1  37263277 Oak S\$499.00  
 37265745 Walnut S\$569.00  
 W120 x D28.5 x H200cm  
 Tolerable weight: Top storage area: overall shelf 20kg, centre top board: 40kg  
 \*Only for special order.



**Stacking Shelf 5R2L Add On**  
 2  37263291 Oak S\$399.00  
 37267039 Walnut S\$479.00  
 W80 x D28.5 x H200cm  
 Tolerable weight: Top storage area: overall shelf 20kg, centre top board: 30kg  
 \*Only for special order.



**Stacking Shelf 5R3L Add On (T-shape)**  
 3  37263284 Oak S\$199.00  
 37265752 Walnut S\$229.00  
 W118 x D28.5 x H40cm  
 Tolerable weight: Top board: 40kg  
 \*Only for special order.



**Stacking Shelf 5R2L Add On (T-shape)**  
 4  37263307 Oak S\$129.00  
 37267046 Walnut S\$159.00  
 W78 x D28.5 x H40cm  
 Tolerable weight: Top board: 30kg  
 \*Only for special order.



**| Stacking Shelf Set |**

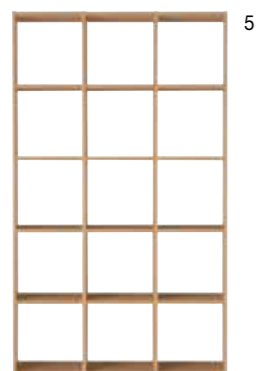

**Stacking Shelf Set 5R3L**  
 5  37263611 Oak S\$729.00  
 37267053 Walnut S\$799.00  
 W122 x D28.5 x H200cm  
 Tolerable weight: 20kg per shelf, overall shelf 90kg



**Stacking Shelf Set 5R2L**  
 6  37263628 Oak S\$519.00  
 37267060 Walnut S\$569.00  
 W82 x D28.5 x H200cm  
 Tolerable weight: 20kg per shelf, overall shelf 60kg



**Stacking Shelf Set 3R3L**  
 7  37263635 Oak S\$609.00  
 37267077 Walnut S\$699.00  
 W122 x D28.5 x H121cm  
 Tolerable weight: 20kg per shelf, overall shelf 60kg



**Stacking Shelf Set 3R2L**  
 8  37263970 Oak S\$399.00  
 37267084 Walnut S\$469.00  
 W82 x D28.5 x H121cm  
 Tolerable weight: 20kg per shelf, overall shelf 40kg



**| Stacking Drawers |**



**Stacking Chest Drawers 2 Tiers**  
 9  37414723 Oak S\$109.00  
 37414754 Walnut S\$129.00  
 W37 x D28 x H37cm



**Stackable Chest 4 Tier Shelf**  
 10  37414747 Oak S\$129.00  
 37414778 Walnut S\$149.00  
 W37 x D28 x H37cm



**Stacking Chest Drawers 4 Tiers**  
 11  37414730 Oak S\$129.00  
 37414761 Walnut S\$149.00  
 W37 x D28 x H37cm



Tolerable weight: Top board 5kg, 3kg per drawer, overall 5kg

**Structure of Stacking Shelf**

**You can build your own storage unit just by combining the basic and additional units.**

As shown in the drawing below, the units can be easily combined by joining the steel pipes inside the partition plate and then fastening them with bolts.

**Stacking Method**

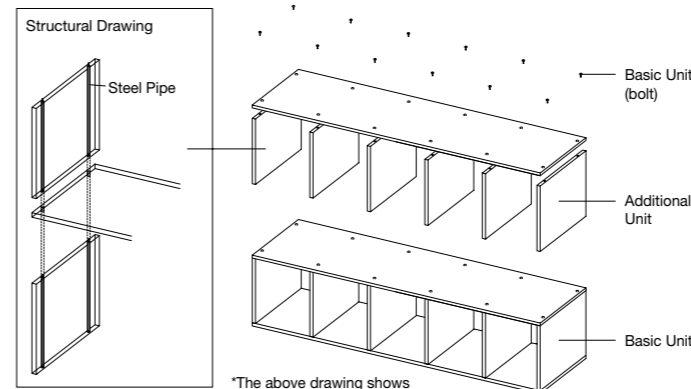

**Examples of combinations and load capacity**

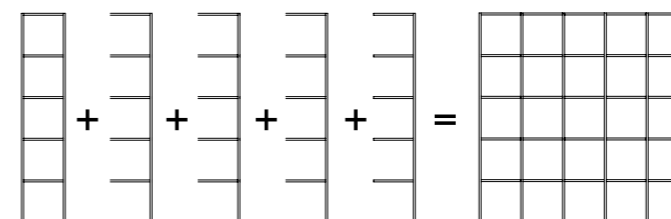

This is the combination method to join the units placed upright in a sideways direction.

Load capacity: Total 150kg = 60kg x 5units / 2

For combined unit:  
 Total load capacity: Load capacity of a unit x number of units / 2

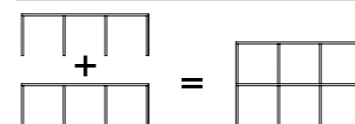

This is the combination method to join the units placed on their side in an upward direction.

Load capacity: Total 40kg = 40kg x 2units / 2

For combined unit:  
 Total load capacity: Load capacity of a unit x number of units / 2

**Example of Use**

**Using the unit with partition plates removed and only with steel pipes**

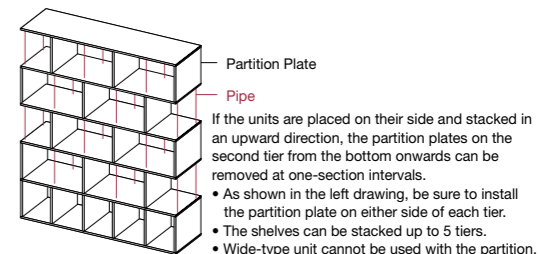
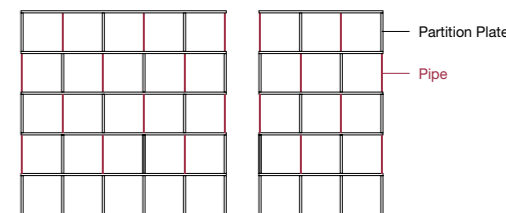

**Combining units with different number of tiers**

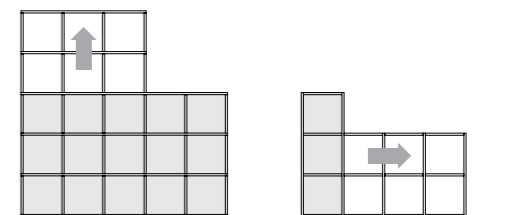

• The shelves can be stacked up to 5 tiers.  
 • Wide-type unit cannot be placed on its side.

**Combining units with different widths**

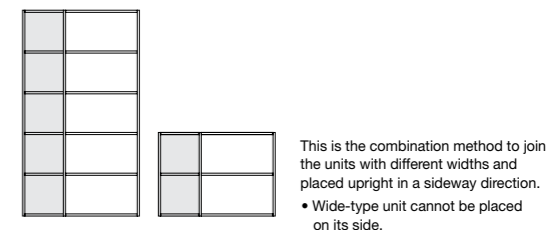

**Using the unit as a partition**

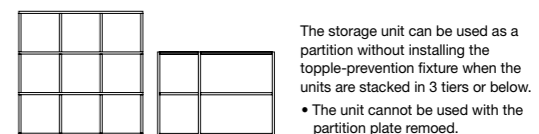

**Structure of Open-Type Stacking Shelf**

You can build your own storage unit just by combining the basic and open-type parts with steel pipes.

**Combination Example 1**

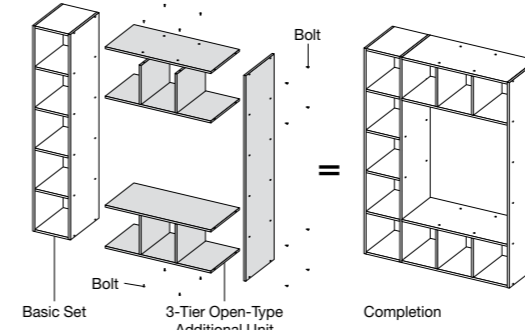

**Combination Example 2**

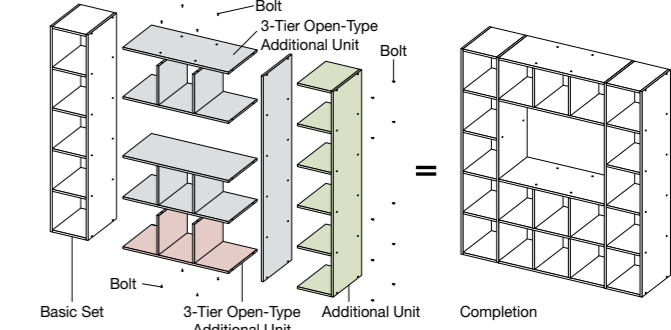



## Stacking Cabinets

Cabinets that is made possible to create original storage by combining a standard set with additional components. Whether it is to make an A/V rack, a bookshelf, or storage furniture for the living room or bedroom, storage units to suit each need can be created simply by combining components of your choice.



**Stackable Cabinet Set - 162.5cm**  
 1 [15256983](#) **S\$479.00**  
 W162.5 x D39.5 x H45cm  
 Tolerable weight: Top board 65kg, 5kg per shelf

**Stackable Cabinet Set Add On - 162.5cm**  
 2 [18805990](#) **S\$429.00**  
 W162.5 x D39.5 x H40cm



**Stackable Cabinet Set - 82.5cm**  
 3 [15256976](#) **S\$289.00**  
 W82.5 x D39.5 x H45cm  
 Tolerable weight: Top board 40kg, 5kg per shelf

**Stackable Cabinet Set Add On - 82.5cm**  
 4 [18805978](#) **S\$249.00**  
 W82.5 x D39.5 x H40cm



**Stackable Cabinet High Add On**  
 5 [18708468](#) **S\$569.00**  
 W162.5 x D39.5 x H79.5cm  
 Tolerable weight: Top board 30kg

The high type (additional set) can only be installed on the second stack and 1 stack of the additional set can be added onto it (width 162.5cm type only)



[Oak]  
 Top surface: flush structure, oak veneer, UV-cured coating  
 Shelf: particle board, oak veneer, UV-cured coating  
 Bottom: MDF, oak veneer, UV-cured coating  
 Side panel, divider: flush structure, oak veneer, UV-cured coating  
 Steel pipes: steel, epoxy powder coating  
 Legs: steel (H: 3 cm)

[Walnut]  
 Top surface: flush structure, walnut veneer, UV-cured coating  
 Shelf: particle board, walnut veneer, UV-cured coating  
 Bottom: MDF, walnut veneer, UV-cured coating  
 Side panel, divider: flush structure, walnut veneer, UV-cured coating  
 Steel pipes: steel, epoxy powder coating  
 Legs: steel (H: 3 cm)

### Additional Parts |



**Stacking Cabinet Dividing Board**  
[18806003](#) **S\$39.00**  
 T2.5 x D37.5 x H37.5cm



**Stackable Cabinet Glass Door**  
[18806034](#) Set of 2 pieces **S\$59.00**  
 Glass door type can only be used on the bottom stack. It cannot be used on the second or third stack.



**Stackable Cabinet Drawer Large**  
[18806010](#) **S\$79.00**  
 W77.5 x D37.5 x H17.5cm



**Stackable Cabinet Wooden Door**  
[18806027](#) Set of 2 pieces **S\$79.00**

### Construction of the stacking cabinet

Stack them up to get the style convenient for you and combine them with the optional parts to get a really handy cabinet.

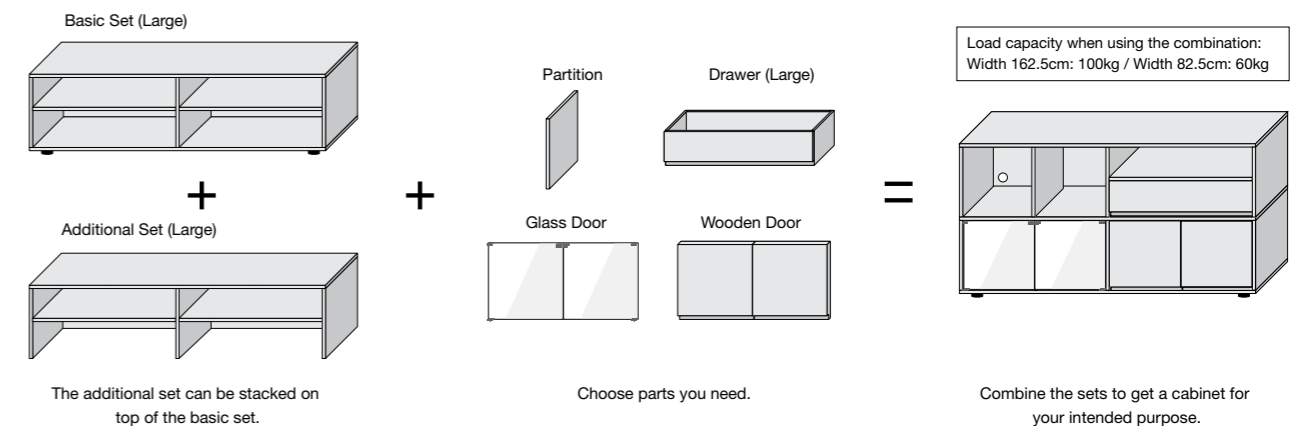

- Tolerable load when used in combination  
 Width: 162.5cm: 100kg in total  
 Width: 82.5cm: 60kg in total
- Do not place a TV set whose size protrudes out of the top board.
- Drawers can be fixed up to the third tier.
- For safety reasons, please restrain the use of glass doors at the lowest tier as a precautions against breakages and falling out.

- The sets can be stacked up to 5 tiers. The legs can also be removed. However, a movable rack must be fixed at that location. In addition, the glass or wooden door cannot be used at that location. the back boards at locations using the high type cannot be removed. (Used it when using large AV amplifiers or appliances that generate high heat.)

## Oak Storage

A warm wooden storage that can be easily used in the living room, dining room, kitchen or even bedroom. This series has standardized depth for easy combination with other storage range. Choose and arrange at your will.



**Oak Chest 4 Row - 120cm**  
 [15874842] Natural **S\$799.00**  
 W120 x D40 x H83cm  
 Tolerable weight: Top board 30kg, 5kg per drawer



**Oak Chest 4 Row - 80cm**  
 [15874859] Natural **S\$469.00**  
 W80 x D40 x H83cm  
 Tolerable weight: Top board 30kg, 5kg per drawer



**Oak Chest 6 Row - 80cm**  
 [15874866] Natural **S\$799.00**  
 W80 x D40 x H119.5cm  
 Tolerable weight: Top board 30kg, 5kg per drawer



**Oak Cabinet 3 Doors**  
 [15877843] Natural **S\$799.00**  
 W120 x D40 x H83cm  
 Tolerable weight: Top board 30kg, 10kg per shelf



**Oak Cabinet 2 Doors**  
 [15877829] Natural **S\$579.00**  
 W80 x D40 x H83cm  
 Tolerable weight: Top board 30kg, 10kg per shelf



**Oak Dresser With Stool**  
 [15874972] Natural **S\$469.00**  
 W46 x D36.5 x H72cm  
 Tolerable weight: Top board 15kg, storage unit 10kg  
 \* Please be careful not to catch your fingers between the lid and the main unit when opening/closing the lid.

[Dresser, Oak]  
 Main unit Legs: natural oak  
 Top surface, side panels: particle board, oak veneer  
 Stool Legs: natural oak Seat: urethane foam Outer shell: 100% cotton, urethane resin coating

[Chest, Oak]  
 Main unit: flush structure, oak veneer  
 Legs: natural wood (laminated oak), urethane resin coating



\* Some areas of the rear panel are fastened with a tacker.  
 \* Due to the use of natural wood, the colour of each product may slightly vary. The colour may also appear different under different lighting.  
 \* The characteristics of natural wood, such as the colour and grain pattern, may vary in appearance depending on the material.  
 \* Withstand loads are calculated based on evenly distributed weight.

## Side Furniture, Mirror, Coat Stand

Side furniture shaped in a minimalistic manner add to the joy of coordination with other furniture along with mirrors and coat hangers available in different materials and sizes. Each has been designed by using the advantages of each material.



**Oak Mirror**  
 [15874880] **S\$189.00**  
 W44 x D33 x H150.5cm  
 Frame: natural oak  
 Rear panel: MDF, urethane resin coating



This unit can be placed alongside a coat hanger.



**Pinewood Mirror**  
 [18122868] **S\$99.00**  
 W36 x D50 x H145cm  
 Pine, lacquer coating  
 Although pine is soft and is easily scratched due to the nature of the material, this will not cause problems in daily use.



**Aluminium Compact Mirror With Tray**  
 [15574940] Large **S\$43.00**  
 W20.5 x D18 x H34-44cm  
 [15574957] Small **S\$33.00**  
 W17 x D14 x H27cm  
 Both sides of the Large and Small models are a mirror while one side is a magnifying mirror.



The height can be adjusted in a stepless manner with the large size.



**Beech Coat Stand**  
 [61013107] **S\$99.00**  
 W48 x D42 x H173.5cm  
 Natural beechwood, lacquer coating  
 Withstand load: 15 kg  
 A three-legged coat hanger with a small footprint. This product can be carried home as it is designed to be assembled.  
 \*Please be sure to observe the withstand load. Make sure that children, etc. do not hang on this product.



**Oak Coat Hanger**  
 [15874873] **S\$169.00**  
 W44 x D53.5 x H150.5cm  
 Frame, shelf: natural wood veneer fibre board (oak veneer), urethane resin coating  
 Tolerable weight: Shelf 10kg, Hanger 10kg  
 Equipped with a shelf for storage of bags and small items. Designed to match the angle of the large mirror for a clean appearance when placed alongside each other.



**Steel Tray Stand**  
 [38326458] **S\$59.00**  
 W45.5 x D34.5 x H51.5cm  
 \*Wooden Tray sold separately.  
 Frame: steel, epoxy powder coating  
 A tray stand which can also be used in combination with the separately sold wooden tray. This unit can be used upright or on its side.



**Wooden Tray**  
 [61010502] Ash **S\$23.00**  
 W46 x D35 x H1.5cm  
 An LVL tray made of ash which is also used as a material for furniture.



**Ash Dust Box**  
 [18340170] **S\$43.00**  
 W28.5 x D15.5 x H30.5cm



**Ash Dust Box With Lid**  
 [76856085] **S\$49.00**  
 Dia23.5 x H30cm



**Aluminium Dust Box**  
 [76023739] **S\$16.90**  
 Dia22 x H25cm

# Stainless Steel Unit Shelf

Stainless Steel Unit Shelves made with selectable parts to match your style and convenience. Construct your own functional shelf for any purpose, from laundry rack to wardrobe, bookshelf, and desk.

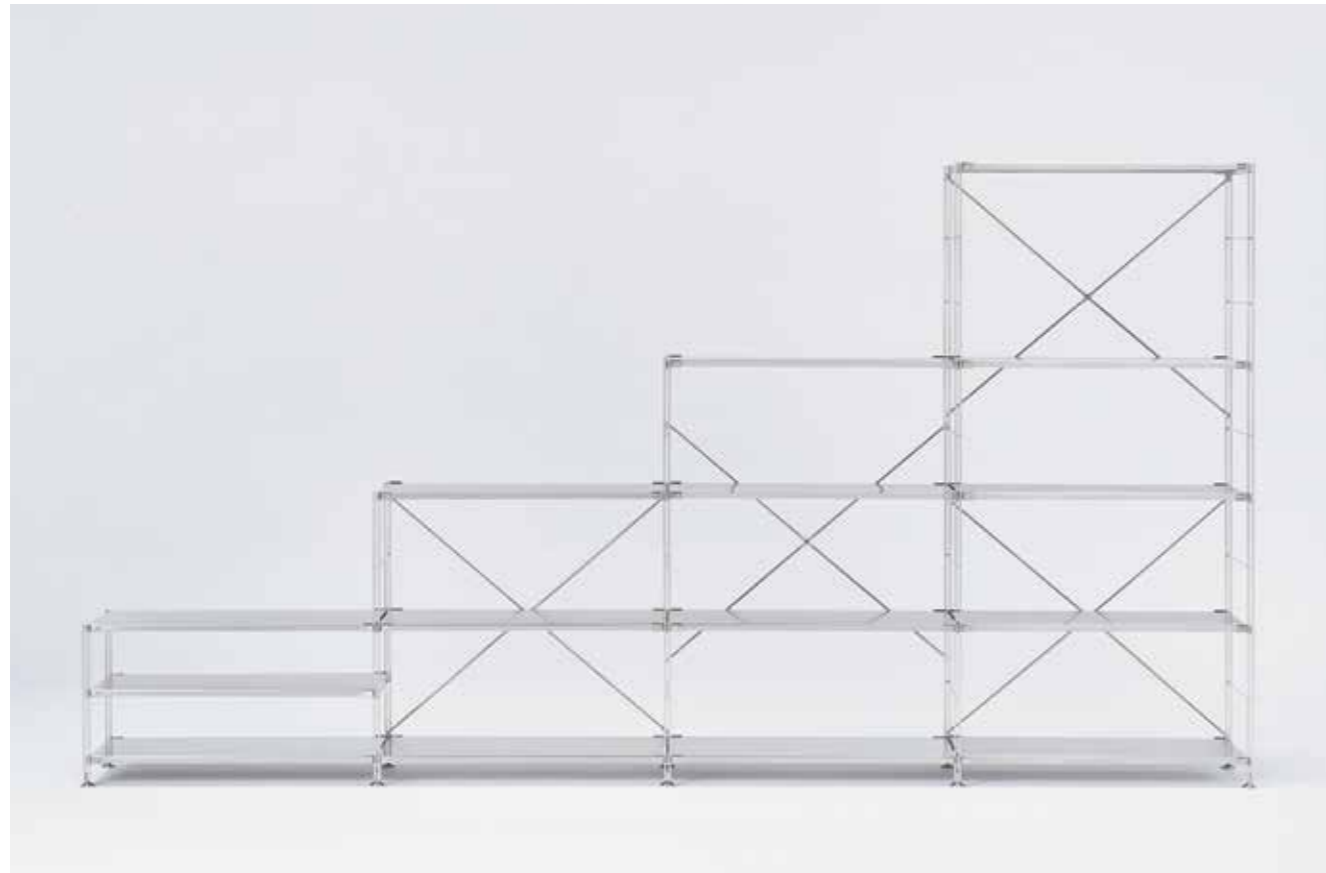

\*Picture is for illustration purpose only

## Structure of Unit Shelf

Construct your own shelf perfect for your room by freely combining the shelf boards, frames, and other parts as desired.

**Basic structure** ..... The body of the Unit Shelf consists of frames, shelf boards, and cross bars.

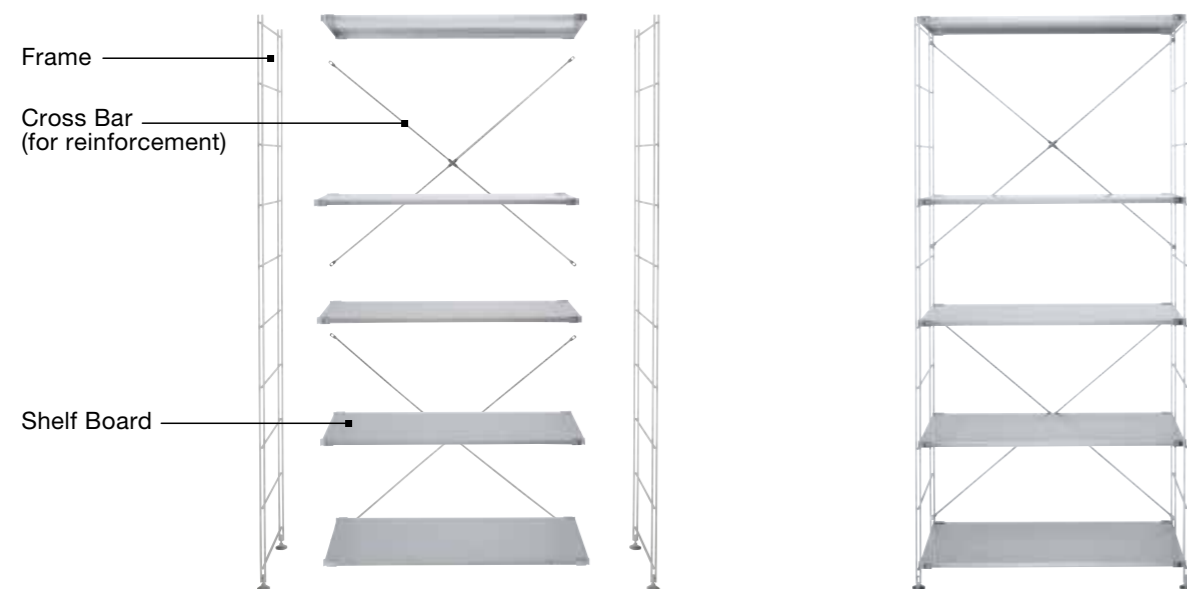

**Optional parts** ..... Add optional parts to create a shelf of your preference.

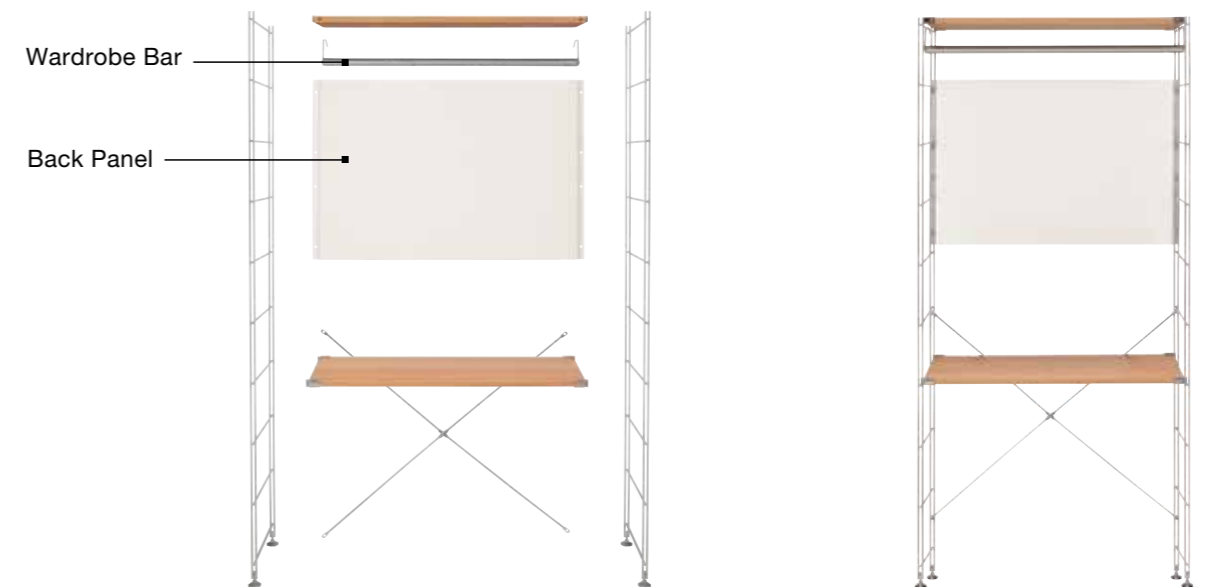



## Stainless Steel Unit Shelf Set

The basic combinations are provided as sets in two different sizes. Shelves are available in 3 types: Stainless steel, Oak, and Walnut.

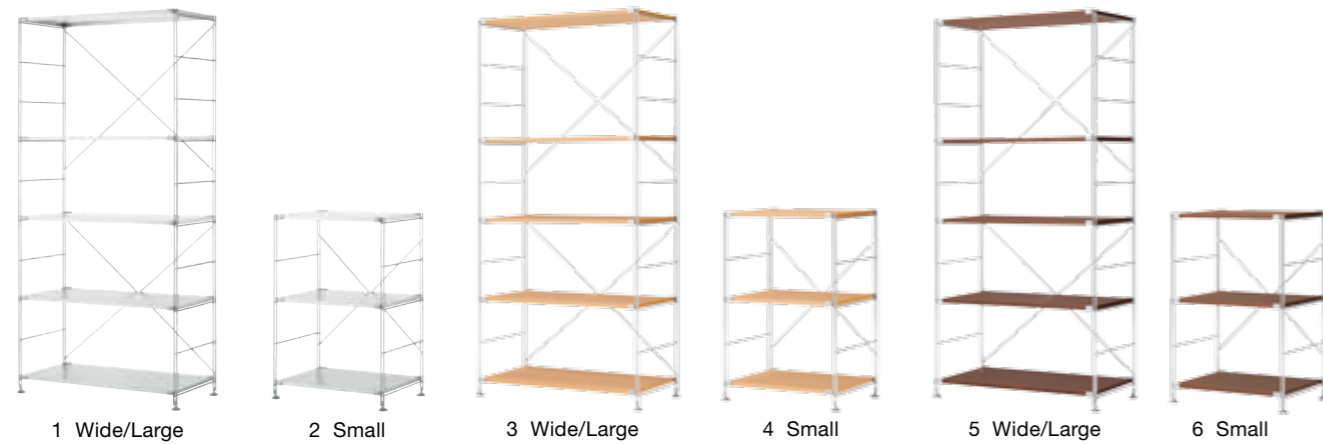

### Stainless Steel Unit Shelf

1	61179063	Wide/Large	S\$509.00
	61179032	Large	S\$459.00
	61179070	Wide/Medium	S\$459.00
	61179049	Medium	S\$349.00
	61179087	Wide/Small	S\$339.00
2	61179056	Small	S\$279.00

### Oak Shelf Set

3	37238992	Wide/Large	S\$609.00
	37236493	Large	S\$509.00
	37239005	Wide/Medium	S\$509.00
	37238978	Medium	S\$459.00
	37239012	Wide/Small	S\$389.00
4	37238985	Small	S\$339.00

### Walnut Shelf Set

5	37236462	Wide/Large	S\$629.00
	37236424	Large	S\$529.00
	37236479	Wide/Medium	S\$529.00
	37236431	Medium	S\$469.00
	37236486	Wide/Small	S\$399.00
6	37236455	Small	S\$349.00

Wide/Large: W 86 x D 41 x H 175.5 cm  
Wide/Medium: W 86 x D 41 x H 120 cm  
Wide/Small: W 86 x D 41 x H 83 cm



Large: W 58 x D 41 x H 175.5 cm  
Medium: W 58 x D 41 x H 120 cm  
Small: W 58 x D 41 x H 83 cm



## Shelf Board

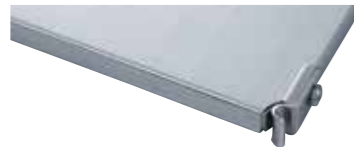

### Additional Stainless Steel Shelf

61179155	For 84cm wide unit	S\$79.00
61179162	For 56cm wide unit	S\$59.00
61179179	For 42cm wide unit	S\$49.00

Stainless steel hairline finish

### Additional Oak Shelf

37167025	For 84cm wide unit	S\$89.00
37167032	For 56cm wide unit	S\$69.00
37167049	For 42cm wide unit	S\$59.00

Shelf board: MDF, oak veneer, UV-cured coating  
Hook: stainless steel  
This type of shelf board for unit shelf uses oak for the sliced veneer.

### Additional Walnut Shelf

37167056	For 84cm wide unit	S\$99.00
37167056	For 56cm wide unit	S\$79.00
37167070	For 42cm wide unit	S\$69.00

Shelf board: MDF, oak veneer, UV-cured coating  
Hook: stainless steel  
This type of shelf board for unit shelf uses oak for the sliced veneer.

[Withstand Load]  
Individual shelf: Approx. 30 kg  
175.5 cm tall unit: Max. 100 kg  
120 cm tall unit: Max. 75 kg  
83 cm tall unit: Max. 50 kg  
46 cm tall unit: Max. 30 kg  
\* When load is distributed evenly across entire unit

[Effective Inside Dimensions]  
112 cm wide unit: W 108 x D 39.5 cm  
84 cm wide unit: W 80 x D 39.5 cm  
56 cm wide unit: W 52 x D 39.5 cm  
42 cm wide unit: W 38 x D 39.5 cm



\*Picture is for illustration purpose only

## Frame and Cross Bar

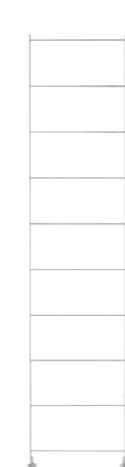

### Additional Stainless Frame

3	61179223	Large	S\$109.00
	61179230	Medium	S\$89.00
	61179247	Small	S\$59.00
	61179254	Mini	S\$49.00

### Stainless Cross Bar

61179261	Large / for 85cm wide unit	S\$26.00
61179278	Small / for 42-56cm wide unit	S\$23.00

Cross Bars provide stability between shelf frames.

### Additional Frame Sizes

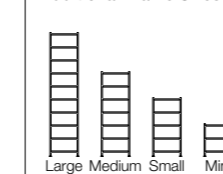

Large: For 175.5 cm tall unit  
Medium: For 120 cm tall unit  
Small: For 83 cm tall unit  
Mini: For 46 cm tall unit



**| Height Adjustment Bracket |**



**Height Adjustment Bracket**  
**76580850** Set of 4 **S\$19.00**  
 Steel, nickel plating

Enable shelf height adjustment by replacing the standard shelf brackets with these parts.  
 \* Up to 3 sets of Height Adjustment Brackets (enough for 3 shelf boards) can be used for each set of shelves.  
 \* Shelves with Height Adjustment Brackets attached can be raised up approximately 9.5 cm higher.  
 \* Make sure to consider the height of the other shelves that do not use Height Adjustment Brackets.  
 \*1



Usage example

**| Auxiliary Parts |**



**Reinforcement Part For Frame / 41cm Deep Type**

**76580874** For 84cm wide unit **S\$43.00**  
 Inside dimensions: W78 X D36cm

**76580881** For 56cm wide unit **S\$39.00**  
 Inside dimensions: W50 X D36cm

Steel, nickel plating  
 Attach this Reinforcement Part instead of the bottom shelf, and use the empty space for large items such as a washing machine or refrigerator.



Usage example

**| Side Panel |**



**Side Panel / 2 Compartment Type**  
**76580898** Light Gray **S\$23.00**  
**76580904** Dark Gray  
 Steel, epoxy powder coating



**Side Panel / 3 Compartment Type**  
 1 **76581390** Light Gray **S\$33.00**  
**076581406** Dark Gray  
 Steel, epoxy powder coating  
 Side panels can be easily attached on a crosspiece of the frame, which enables the unit shelf to be used as a bookshelf.

**| Back Panel |**



**Back Panel / S / Light Grey (2 Compartment Type)**  
 2 **76580959** 84cm wide unit **S\$26.00**  
**76580966** 56cm wide unit **S\$23.00**  
 Steel, epoxy powder coating



**Back Panel / S / Dark Grey (2 Compartment Type)**  
 3 **76580997** 84cm wide unit **S\$26.00**  
**76581000** 56cm wide unit **S\$23.00**  
 Steel, epoxy powder coating



**Back Panel / L / Light Grey (3 Compartment Type)**  
 5 **76580973** 84cm wide unit **S\$39.00**  
**76580980** 56cm wide unit **S\$33.00**  
 Steel, epoxy powder coating



**Back Panel / L / Dark Grey (3 Compartment Type)**  
 6 **76580775** 84cm wide unit **S\$39.00**  
**76580782** 56cm wide unit **S\$33.00**  
 Steel, epoxy powder coating

Back Panels can reduce swaying of the shelves and allow shelves to be used as partitions. Magnets can be attached to light grey and dark grey types.

**| Wardrobe Bar |**



**Unit Shelf Wardrobe Bar**  
**61179797** 84cm wide unit **S\$33.00**  
**61179803** 56cm wide unit **S\$29.00**  
 Stainless steel hairline finish  
 Withstand load: 10kg



Usage example

**| Reference Table for Required Number of Unit Shelf Parts |**

To ensure a certain level of stability for Unit Shelves, a specified number of parts are required for assembly. Refer to the table below for the minimum number of parts required for your particular configuration.

Frame size		Large	Medium	Small	Mini
W 112 cm	Shelf Board	3	3	2	3
	Cross Bar / Extra large	2	1	1	0
W 84 cm	Shelf Boards or Reinforcement Part For Frame	3	3	2	3
	Cross Bar / Large	2	1	1	0
W 56 cm	Shelf Boards or Reinforcement Part For Frame	3	3	2	3
	Cross Bar / Small	2	1	1	0
W 42 cm	Shelf Board	3	3	2	3
	Cross Bar / Small	2	1	1	0

\* The stability may also vary depending on the location of the assembled parts. The stability of the unit may decrease if the shelf boards are not evenly spaced, even if more than the required number of parts are used.  
 In particular, if you do not use a shelf board at the top or bottom of the unit, or if you leave excess space between shelves, it may cause the unit to be shaky. Make sure to install the shelf boards so that they are evenly spaced.  
 \* Side Panels, and the Additional Shelf / Narrow Type are not designed to function effectively as Reinforcement Part For Frame.  
 \* The required number of parts may vary when Cross Bars are used to replace the Back Panel, depending on the configuration.  
 For more information, please approach our store staff for assistance.

**| Notes on using Unit Shelf Parts |**

Unit Shelves cannot be assembled in the configurations shown in the illustrations below.

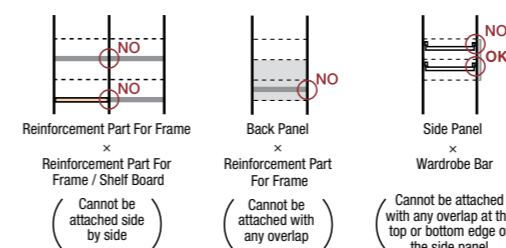









\*1 This item cannot be attached to an Additional Stainless Steel Shelf / Wire Type or Additional Shelf / Narrow Type.

# Steel Unit Shelf

Available in a variety of heights, this Steel Unit Shelf can be customised to meet your storage requirements. The base material is steel, and the grey colour is suitable for any space.

## | Basic Set - Depth 41cm |

Wide/Large: W 86 × D 41 × H 175.5 cm		Large: W 58 × D 41 × H 175.5 cm	
Wide/Medium: W 86 × D 41 × H 120 cm		Medium: W 58 × D 41 × H 120 cm	
Wide/Small: W 86 × D 41 × H 83 cm		Small: W 58 × D 41 × H 83 cm	
Wide/Mini: W 86 × D 41 × H 46 cm		Mini: W 58 × D 41 × H 46 cm	

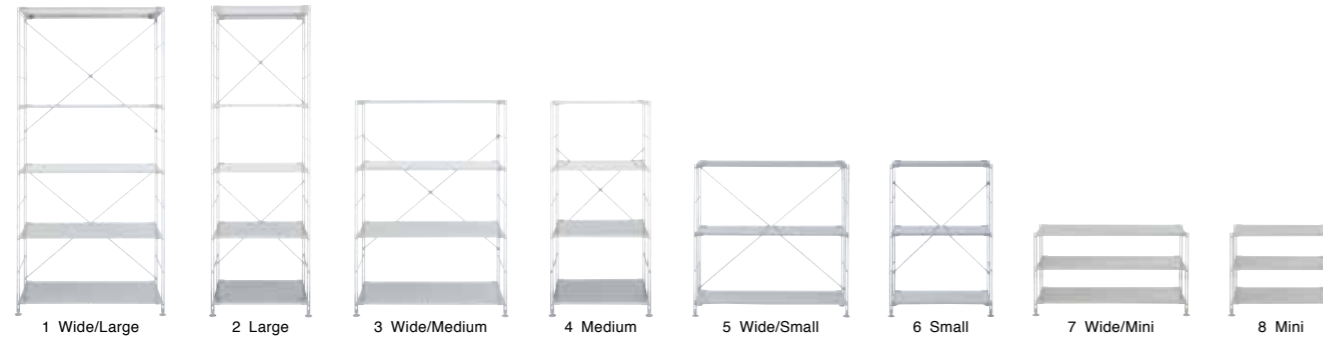

### Steel Shelf Set Wide / Gray

1 [61179391] Wide / Large	S\$279.00
3 [61179407] Wide / Medium	S\$209.00
5 [61179414] Wide / Small	S\$159.00
7 [61179421] Wide / Mini	S\$129.00

Steel, epoxy powder coating

### Steel Frame / Gray

9 [61179629] Large	S\$49.00
[61179636] Medium	S\$39.00
[61179643] Small	S\$29.00
[61179650] Mini	S\$19.00

## | Shelf Boards / Frames - Depth 41cm |



### Additional Steel Shelf / Gray

[61361987] For 112cm wide unit	S\$43.00
[61179551] For 84cm wide unit	S\$33.00
[61179568] For 56cm wide unit	S\$29.00
[61179575] For 42cm wide unit	S\$23.00





Steel shelf: epoxy powder coating

### Additional Wodden Shelf / Gray

[61179582] For 84cm wide unit	S\$49.00
[61179599] For 56cm wide unit	S\$39.00
[61179605] For 42cm wide unit	S\$33.00

Wood shelf: MDF, natural wood veneer, UV-cured coating  
Hooks: steel, epoxy powder coating

### Additional Frame Sizes

	Large: For 175.5 cm tall unit
	Medium: For 120 cm tall unit
	Small: For 83 cm tall unit
	Mini: For 46 cm tall unit

[Withstand load of 41 cm deep units]

Individual shelf: Approx. 30 kg  
175.5 cm tall unit: Max. 100 kg  
120 cm tall unit: Max. 75 kg  
83 cm tall unit: Max. 50 kg  
46 cm tall unit: Max. 30 kg

[Inside dimensions of 41 cm deep units]

112 cm wide unit: W 108 × D 39.5 cm  
84 cm wide unit: W 80 × D 39.5 cm  
56 cm wide unit: W 52 × D 39.5 cm  
42 cm wide unit: W 38 × D 39.5 cm

\* When load is distributed evenly across entire unit

## | Height Adjustment Bracket |



### Height Adjustment Bracket

[76580867] Set of 4 S\$13.90

Steel, epoxy powder coating  
Enable shelf height adjustment by replacing the standard shelf brackets with these parts.

\* Up to 3 sets of Height Adjustment Brackets (enough for 3 shelf boards) can be used for each set of shelves.

\* Shelves with Height Adjustment Brackets attached can be raised up to approximately 9.5 cm higher.

\* Make sure to consider the height of the other shelves that do not use Height Adjustment Brackets.

\*1

## | Crossbar |



### Crossbar - Gray

[61789941] Extra Large	S\$13.00
Width 112cm	
[61179667] Large	S\$10.90
Width 84cm	
[61179674] Small	S\$9.90
Width 42-56cm	

The use of the cross bar is to give stability to joined shelves.

## | Auxiliary Parts |



### Reinforcement Part for Frame / Gray

[61179766] For 84cm wide unit	S\$29.00
Inside dimensions: W 78 × D 36 cm	
[61179773] For 56cm wide unit	S\$23.00
Inside dimensions: W 50 × D 36 cm	

Steel, epoxy powder coating  
Attach this Reinforcement Part instead of the bottom shelf, and use the empty space for large items such as a washing machine or refrigerator.



## Pulp Board Storage

Light and durable storage boxes that can be placed upright or on its side. It is useful as a wall storage furniture, that can join up to 5 units sideways. Available in a wide selection of shapes and sizes.



**Pulp Board Box A4 - 5 Rows**

47549201 S\$63.00  
W37.5 x D29 x H180cm  
Fixed shelf tolerable weight: 15kg per shelf, overall shelf 40kg



18121717 Slim S\$56.00

W25 x D29 x H180cm  
Fixed shelf tolerable weight: 15kg per shelf, overall shelf 40kg



**Pulp Board Box A4 - 4 Rows**

18511341 S\$53.00  
W37.5 x D29 x H144cm  
Fixed shelf tolerable weight: 15kg per shelf, overall shelf 35kg



18511358 Slim S\$49.00

W25 x D29 x H144cm  
Fixed shelf tolerable weight: 15kg per shelf, overall shelf 35kg



**Pulp Board Box A4 - 3 Rows**

47549195 S\$43.00  
W37.5 x D29 x H109cm  
Fixed shelf tolerable weight: 15kg per shelf, overall shelf 25kg



18121700 Slim S\$39.00

W25 x D29 x H109cm  
Fixed shelf tolerable weight: 15kg per shelf, overall shelf 25kg



**Pulp Board Box A4 - 2 Rows**

47549188 S\$26.00  
W37.5 x D29 x H73cm  
Fixed shelf tolerable weight: 15kg per shelf, overall shelf 20kg



18121694 Slim S\$23.00

W25 x D29 x H73cm  
Fixed shelf tolerable weight: 15kg per shelf, overall shelf 20kg

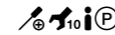

**Pulp Board Box Multi-Rack**

18121724 S\$53.00  
W37.5 x D17.5 x H109cm  
Tolerable weight: 8kg per fixed shelf, overall shelf 25kg



**Pulp Board Box Free Rack**

18121731 S\$49.00  
W25 x D29 x H109cm  
Tolerable weight: 8kg per fixed shelf, overall shelf 25kg



**Pulp Board Box with Caster**

61789712 S\$79.00  
W76 x D29 x H64cm  
Tolerable weight: 15kg per fixed shelf, moveable shelf 8kg, overall shelf 20kg  
Vertical position tolerable weight: 15kg per fixed shelf, overall shelf 20kg



Vertical Position



**Pulp Board Box Joint Clamp**

18960941 S\$3.90  
2Pcs Set



These fittings are to be installed on every other compartment in the lateral direction.



**Notes regarding the metal fittings**  
When placing units sideways, be sure to attach the Metal Joint Fittings For Pulp Board Boxes shown on the left on the rear side of the units in order to prevent tipping.



## Storage Items

# Polypropylene (PP) Storage Case Series

Our PP Storage Case Series are multifunctional; they are stackable, packable and versatile enough to be utilised for practically anything. Combine different size storage case to match the space requirement and usage.

## PP Clothes Drawer | (W40 x D65cm)



**15112081** Large **S\$29.00**  
W40 x D65 x H30cm  
Allowed number of stacks: 6 stacks  
Can be fitted with casters (sold separately)



**15112098** Medium **S\$23.00**  
W40 x D65 x H24cm  
Allowed number of stacks: 7 stacks  
Can be fitted with casters (sold separately)



**15112104** Small **S\$19.00**  
W40 x D65 x H18cm  
Allowed number of stacks: 8 stacks  
Can be fitted with casters (sold separately)



Tolerable weight: about 7kg (with casters: 3.5kg)

## PP Closet Drawer | (W44 x D55cm)



**15199693** Large **S\$29.00**  
W44 x D55 x H30cm  
Allowed number of stacks: 6 stacks  
Can be fitted with casters (sold separately)



**15199709** Medium **S\$23.00**  
W44 x D55 x H24cm  
Allowed number of stacks: 7 stacks  
Can be fitted with casters (sold separately)



**15236640** Small **S\$19.00**  
W44 x D55 x H18cm  
Allowed number of stacks: 8 stacks  
Can be fitted with casters (sold separately)



Tolerable weight: about 7kg (with casters: 3.5kg)

## PP Storage Case Horizontal Wide | (W55 x D44.5cm)



**76331476** Deep **S\$36.00**  
W55 x D44.5 x H30cm  
Tolerable weight: About 2kg (with casters: about 2.5kg)  
Allowed number of stacks: 6 stacks  
Can be fitted with casters (sold separately)



**76331483** Large **S\$29.00**  
W55 x D44.5 x H24cm  
Tolerable weight: About 3kg (with casters: about 3.0kg)  
Allowed number of stacks: 5 stacks  
Can be fitted with casters (sold separately)



**76331490** Small **S\$23.00**  
W55 x D44.5 x H18cm  
Tolerable weight: About 3kg (with casters: about 3.0kg)  
Allowed number of stacks: 5 stacks  
Can be fitted with casters (sold separately)



A wide storage case that can hold 2 pieces of shirts or sweaters side by side.



**18510269** 4 Tier **S\$99.00** **18510252** 3 Tier **S\$73.00**  
W55 x D44.5 x H90cm  
W55 x D44.5 x H67.5cm  
Allowed number of stacks: 5 stacks  
Allowed number of stacks: 5 stacks (add on one stack Horizontal Wide case)  
Tolerable weight: About 9kg, 3kg per stack (with wheels on: about 3kg per stack)  
Can be fitted with casters (sold separately)  
The unit cannot be dismantled mid-way of drawers.



Example of Use



With Casters

## PP Storage Case | (W34 x D44.5cm)



**18816156** Deep **S\$23.00**  
W34 x D44.5 x H30cm  
Allowed number of stacks: 6 stacks  
Can be fitted with casters (sold separately)



**18816163** Large **S\$19.00**  
W34 x D44.5 x H24cm  
Allowed number of stacks: 7 stacks  
Can be fitted with casters (sold separately)



**18816170** Small **S\$16.00**  
W34 x D44.5 x H18cm  
Allowed number of stacks: 9 stacks  
Can be fitted with casters (sold separately)

Tolerable weight: about 5kg (with casters: 3.0kg)



### Combination Examples of Stackable Storage Units

\*First 3 sets: Horizontal Wide, next 3 sets: Storage Case

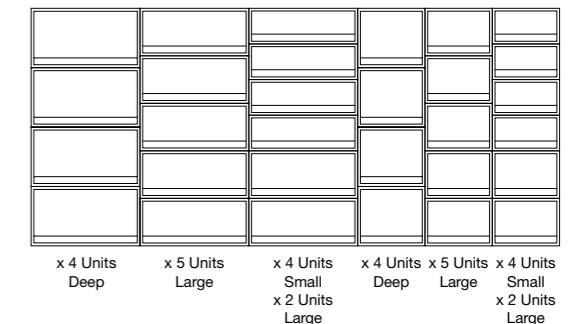

### Semi-transparent boxes - making the best use of polypropylene's natural colour

MUJI made away with the colouring process - a common process to create colourful polypropylene products - to develop these colourless products. Removing the colouring process not only brings the cost down but the semi-transparent result helps in the identification of contents kept in the case while at the same time not showing too much or rather only vaguely showing the contents of the case.

There are 4 series lined up for the large type; these are the "storage case", "clothing case", "closet case" and "wide case". Choose the width, depth and height that suit the size of your cupboard. You can also use the drawer type for dust-proofing or fit in the wheelers to ease transfers of the contents.

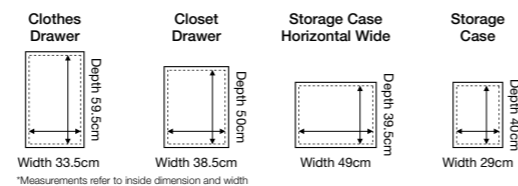

\* Please follow the pre-set "allowable number of stacks" and "tolerable weight" to avoid any untoward accidents.  
\* Due to the nature of polypropylene, there might be a slight variation in the hardening of the propylene cases. When stacked up, the height of each stack might slightly vary.

**PP Storage Drawer - Deep Type | (W26 x D37cm / Half: W14 x D37cm)**



**76749028** 2 Drawers (with partition) **S\$23.00**  
W26 x D37 x H17.5cm

Tolerable weight (with casters): About 2kg per drawer, 2kg top surface



**37192447** **S\$16.00**  
W26 x D37 x H17.5cm

Tolerable weight (with casters): About 4kg per drawer, 2kg top surface



Allowed number of stacks: 6 stacks  
Can be fitted with casters (sold separately)



**76749035** Half / 1 Drawer (with partition) **S\$14.90**  
W14 x D37 x H17.5cm

Tolerable weight (with casters): About 2kg per drawer, 2kg top surface



Allowed number of stacks: 4 stacks  
Can be fitted with casters (sold separately)



Example of Use

**PP Storage Drawer - Shallow Type | (W26 x D37cm / Half: W14 x D37cm)**



**76749004** 6 Drawers (with partition) **S\$49.00**  
W26 x D37 x H32.5cm

Tolerable weight (with casters): About 1.5kg per drawer, 2kg top surface



**37192430** 3 Drawers **S\$29.00**  
W26 x D37 x H32.5cm

Tolerable weight (with casters): About 3kg per drawer, 2kg top surface



Allowed number of stacks: 3 stacks  
Can be fitted with casters (sold separately)



**76748984** 2 Drawers (with partition) **S\$19.00**  
W26 x D37 x H12cm

Tolerable weight (with casters): About 1.5kg per drawer, 2kg top surface



**37192423** **S\$14.90**  
W26 x D37 x H12cm

Tolerable weight (with casters): About 3kg per drawer, 2kg top surface



Allowed number of stacks: 10 stacks  
Can be fitted with casters (sold separately)



**76749042** Half / 1 Drawer (with partition) **S\$13.00**  
W14 x D37 x H12cm

Tolerable weight (with casters): About 1.5kg per drawer, 2kg top surface



Allowed number of stacks: 6 stacks  
Can be fitted with casters (sold separately)

**PP Storage Drawer - Thin Type | (W26 x D37cm)**



**76749073** 2 Tier **S\$19.00**  
W26 x D37 x H16.5cm

Allowed number of stacks: 7 stacks



**76749066** **S\$13.00**  
W26 x D37 x H9cm

Allowed number of stacks: 13 stacks



Can be fitted with casters (sold separately)



**PP Rack | (W37 x D26cm)**



**37150621** Thin **S\$11.00**  
W37 x D26 x H9cm

Tolerable weight: 3kg  
Allowed number of stacks: 13 stacks

Can be fitted with casters (sold separately)  
The maximum stacking height is 120cm  
Tolerable weight (without casters): 39kg  
Tolerable weight (with casters or place reverse): 19.5kg



**37150713** Deep **S\$13.90**  
W37 x D26 x H17.5cm

Tolerable weight: 4kg  
Allowed number of stacks: 6 stacks

**37150720** Deep Large **S\$16.00**  
W37 x D26 x H26cm

Tolerable weight: 5kg  
Allowed number of stacks: 4 stacks

If you are stacking PP Rack on top of each other, please firmly insert the joint parts (provided with PP Rack) to all 4 corners.

\*Even when stacking with other PP Storage such as PP Case Drawer Wide Series, please use the joint parts as well.

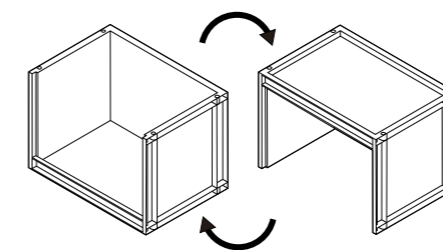
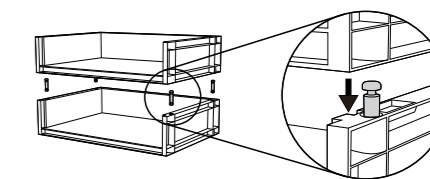

It can be used in both directions.

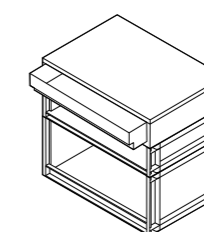

Can be stacked with PP Case Drawer Wide Series (3753/3777/3784/3791).

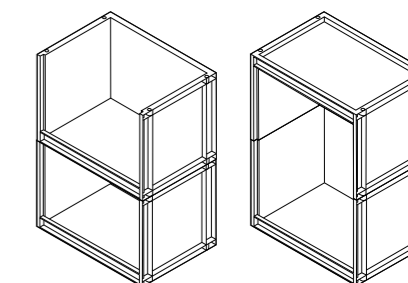

Can be stacked in both directions.

\*Mix & match different height of rack. It can also be fitted with casters, to use it as a wagon.

\*To efficiently utilize a storage space like under the sink. You can adjust the height according to the items you want to store.

PP Storage Drawer - Wide Type | (W37 x D26cm)



15253753 Thin S\$14.90  
W37 x D26 x H9cm  
Tolerable weight (with casters): About 1kg per drawer, 5kg on top  
Allowed number of stacks: 13 stacks  
Can be fitted with casters (sold separately)



15253784 Shallow S\$16.00  
W37 x D26 x H12cm  
Tolerable weight (with casters): About 1.5kg per drawer, 5kg on top  
Allowed number of stacks: 10 stacks  
Can be fitted with casters (sold separately)



Example of Use



15253777 2 Drawers S\$19.00  
W37 x D26 x H9cm  
Tolerable weight (with casters): About 0.5kg per drawer, 5kg on top  
Allowed number of stacks: 13 stacks  
Can be fitted with casters (sold separately)



15253791 Deep S\$17.90  
W37 x D26 x H17.5cm  
Tolerable weight (with casters): About 2kg per drawer, 5kg on top  
Allowed number of stacks: 6 stacks  
Can be fitted with casters (sold separately)

\*This series can be combined with PP Storage Rack on pg22.

PP Carry Box With Lock



18723713 Deep S\$23.00  
W36 x D52 x H33cm  
Tolerable weight (with casters): About 9kg  
Allowed number of stacks: 5 stacks  
Can be fitted with casters (sold separately)



18723690 Large S\$19.00  
W36 x D52 x H16.5cm  
Tolerable weight (with casters): About 7kg  
Allowed number of stacks: 8 stacks  
Can be fitted with casters (sold separately)



61793030 Small / Deep S\$17.90  
W25.5 x D37 x H33cm  
Tolerable weight: About 8kg  
Allowed number of stacks: 5 stacks



18723676 Small S\$14.90  
W25.5 x D37 x H16.5cm  
Tolerable weight: About 5kg  
Allowed number of stacks: 8 stacks



61793016 Small / Thin S\$11.00  
W25.5 x D37 x H8.5cm  
Tolerable weight: About 4kg  
Allowed number of stacks: 14 stacks



Lock Feature

PP Carry Box



47807493 Deep S\$19.00  
W36 x D51 x H33cm  
Tolerable weight (with casters): About 9kg  
Allowed number of stacks: 5 stacks  
Can be fitted with casters (sold separately)



47686692 Large S\$16.00  
W36 x D51 x H16.5cm  
Tolerable weight (with casters): About 7kg  
Allowed number of stacks: 8 stacks  
Can be fitted with casters (sold separately)



47686685 Small S\$11.00  
W25.5 x D36 x H16.5cm  
Tolerable weight: About 5kg  
Allowed number of stacks: 8 stacks



Foldable Type  
47686715 Large S\$23.00  
W36 x D51 x H24.5cm  
Tolerable weight (with casters): About 7kg  
Allowed number of stacks: 8 stacks  
Can be fitted with casters (sold separately)



Foldable Type  
47686708 Small S\$16.00  
W36 x D25.5 x H16.5cm  
Tolerable weight: About 5kg  
Allowed number of stacks: 8 stacks



When Folded



Additional Parts



Stopper for PP Storage - Set of 4 pieces  
1 47554908 Small S\$5.90  
2 47554892 Big S\$5.90  
Silicone Rubber



Caster for PP Storage  
15523788 Set of 4 pieces S\$6.30



Styrol Partition Plate PP Storage  
47479584 Large / Set of 4 pieces S\$16.00  
W65.5 x D0.2 x H11cm



Height Adjustable Nonwoven Fabric Separation Case

38309772 L / 2 Pcs S\$16.00 W22.5 x D32.5 x H21cm  
38309765 M / 2 Pcs S\$13.90 W15 x D32.5 x H21cm  
38309758 S / 2 Pcs S\$11.60 W11 x D32.5 x H21cm

100% polypropylene  
Use these cases to partition inside a variety of storage units. Height can be adjusted by folding the top edges. They are also useful as inside covers for natural material storage units.



Usage example

Sample uses of height adjustable nonwoven fabric separation case

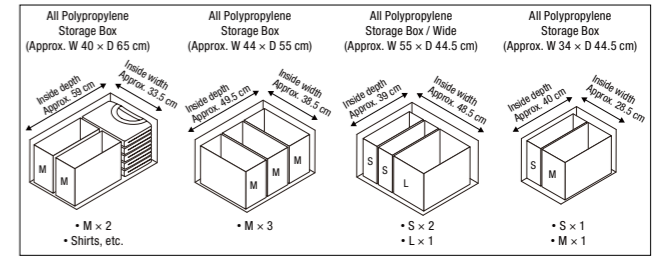

PP Stocker



15521821 4 Tier S\$46.00  
W18 x D40 x H83cm  
Allowed number of stacks:  
Shallow (15880171): +3 stacks  
Medium (47721584): +2 stacks  
Deep (15880164): +1 stack



(1) 1xMedium + 2xDeep S\$49.00  
15880188 3 Tier S\$49.00  
W18 x D40 x H83cm  
Allowed number of stacks:  
Shallow (15880171): +3 stacks  
Medium (47721584): +2 stacks  
Deep (15880164): +1 stack



(2) 2xMedium + 1xDeep + 1xShallow S\$56.00  
15880195 4 Tier S\$56.00  
W18 x D40 x H83cm  
Allowed number of stacks:  
Shallow (15880171): +3 stacks  
Medium (47721584): +2 stacks  
Deep (15880164): +1 stack



(3) 1xMedium + 3xDeep + 1xShallow S\$76.00  
15880201 5 Tier S\$76.00  
W18 x D40 x H122cm



(4) 3xMedium + 1xDeep + 1xShallow S\$79.00  
15880218 5 Tier S\$79.00  
W18 x D40 x H122cm

PP Stoker Drawer Add On Parts



<b>[15880164]</b> Deep <b>S\$19.00</b> W18 x D40 x H30.5cm Allowed number of stacks: 4 stacks Ⓢ ⓐ Ⓜ Ⓟ	<b>[47721584]</b> Medium <b>S\$13.00</b> W18 x D40 x H21cm Allowed number of stacks: 5 stacks Ⓢ ⓐ Ⓜ Ⓟ	<b>[15880171]</b> Shallow <b>S\$11.00</b> W18 x D40 x H11cm Allowed number of stacks: 10 stacks Ⓢ ⓐ Ⓜ Ⓟ
--	--	--

**PP Wagon With Casters**  
[15253807] 3 Tiers **S\$29.00**  
W29 x D41.5 x H83cm



\* Remove the top cover or caster to add on PP stack in the desired combination to create your original design.  
\* The maximum stacking height is 122 cm.  
**Note:** The units cannot be dismantled mid-way

Stackable Storage Unit Guide & Size Module

Stackable Storage Unit Guide

	Maximum Estimated Load (with caster fitted on)			Approximate Single Tier Storage Capacity
	Per Tier	Top Surface	Total	
Add On [15880164] Deep Type	±5kg	±3kg	±30kg	1000ml bottles x 4
Add On [47721584] Medium	±5kg	±3kg	±30kg	350ml cans x 4
Add On [15880171] Shallow Type	±2.5kg	±3kg	±30kg	

Stackable Storage Unit Guide

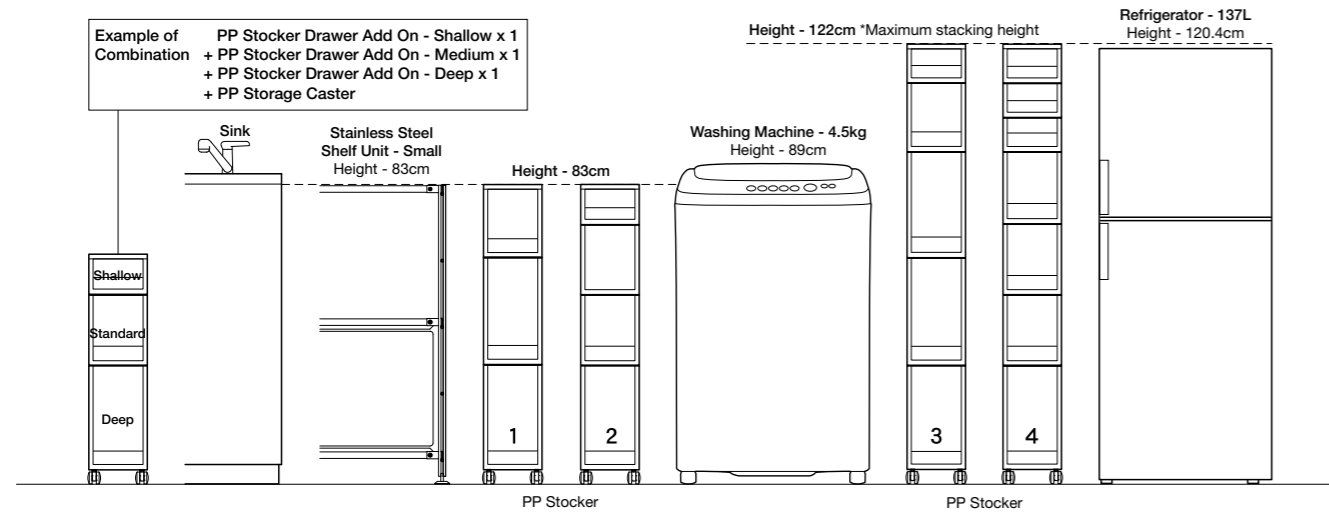
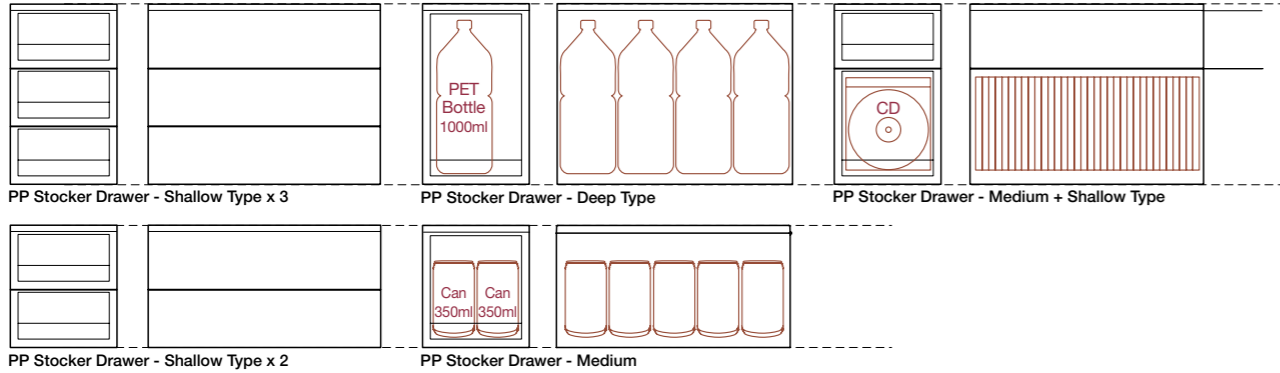

Polypropylene Strong Storage Box



Usage example

<b>[37525986]</b> M <b>S\$29.00</b> Approx. W 60.5 x D 39 x H 37 cm Withstand load: (Lid) approx. 100 kg (Storage) approx. 13.5 kg Stacking limit: 3 units Capacity: 50 L	<b>[61050652]</b> M <b>S\$19.00</b> Approx. W 40.5 x D 39 x H 37 cm Withstand load: (Lid) approx. 100 kg (Storage) approx. 13.5 kg Stacking limit: 3 units Capacity: 30 L
---	---

Polypropylene Strong Storage Box can be used outdoors

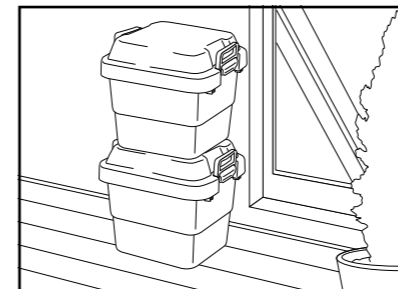

Good for outdoor storage on the balcony or under the eaves. Large and small types are stackable up to 3 units.

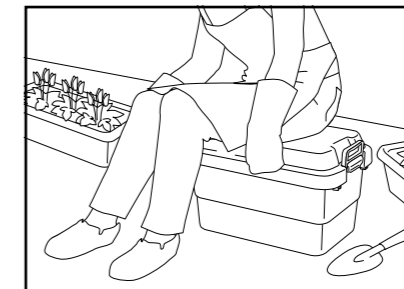

Use as a chair during gardening or other outdoor activities.

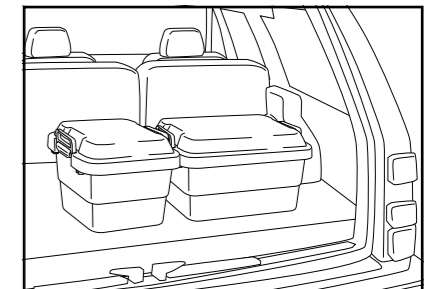

Organise your trunk--these storage boxes are robustly designed to withstand vehicle vibrations.





## Stackable Storage Basket

Natural-looking hand-woven baskets made from good quality materials from the Philippines and Vietnam are light, easy to handle and smooth to touch. These storage baskets come in standard sizes for easy storing and stacking.

 <p><b>Bouli Rectangular Basket</b> 47027907 Small S\$16.00 W37 x D26 x H12cm A4</p> <p><b>Bouli Rectangular Basket Lid</b> 18014026 S\$6.90 W37 x D26 x H2cm *Can be used for S, M, L Basket</p>	 <p><b>Bouli Rectangular Basket</b> 47027914 Medium S\$19.00 W37 x D26 x H16cm A4</p>	 <p><b>Bouli Rectangular Basket</b> 18014002 Large S\$26.00 W37 x D26 x H24cm A4</p>	
 <p><b>Bouli Rectangular Basket</b> 47027921 Extra Small S\$13.00 W26 x D18.5 x H12cm A4</p> <p><b>Bouli Rectangular Basket Lid</b> 18014033 S\$5.30 W26 x D18.5 x H2cm</p>	 <p><b>Bouli Square Basket</b> 47027938 Medium S\$23.00 W35 x D37 x H16cm A4</p> <p><b>Bouli Square Basket Lid</b> 18014019 S\$9.30 W35 x D37 x H2cm *Can be used for M, L, XL Basket</p>	 <p><b>Bouli Square Basket</b> 18013999 Large S\$33.00 W35 x D37 x H24cm A4</p> <p><b>Bouli Square Basket</b> 47027945 Extra Large S\$36.00 W35 x D37 x H32cm A4</p>	
 <p><b>Rattan Rectangular Basket</b> 47381290 Small S\$33.00 W36 x D26 x H12cm A4</p> <p><b>Rattan Rectangular Basket Lid</b> 15004768 S\$16.00 W36 x D26 x H3cm</p>	 <p><b>Rattan Rectangular Basket</b> 47381306 Medium S\$39.00 W36 x D26 x H16cm A4</p>	 <p><b>Rattan Rectangular Basket</b> 47381313 Large S\$49.00 W36 x D26 x H24cm A4</p>	 <p><b>Rattan Rectangular Basket</b> 38309819 Extra Large S\$76.00 W36 x D26 x H31cm A4</p>
 <p><b>Rattan Rectangular Box</b> 47381238 Small S\$33.00 W36 x D18 x H12cm A4</p>	 <p><b>Rattan Rectangular Box With Lid</b> 47381337 S\$36.00 W26 x D18 x H16cm A4</p>	 <p><b>Rattan Rectangular Box With Handle</b> 47028454 S\$23.00 W15 x D22 x H9cm A4</p>	 <p><b>Rattan Square Basket</b> 18021833 Medium S\$56.00 W35 x D36 x H18cm A4</p> <p><b>Rattan Square Basket Lid</b> 15004775 S\$19.00 W35 x D36 x H3cm</p>
 <p><b>Rattan Rectangular Box</b> 47028454 Extra Small S\$23.00 W26 x D9 x H6cm A4</p>			 <p><b>Rattan Square Basket</b> 18021826 Large S\$79.00 W35 x D36 x H24cm A4</p>

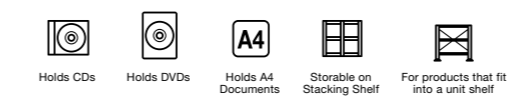

Cleaning natural storage boxes: Avoid using at humid areas. Take it out under the sun regularly and clean it from dust using a vacuum or a brush.

## Cotton Linen Polyester Soft Box Storage

Coated on the inside, MUJI's foldable fabric boxes are made from polyester, cotton, and hemp. The modules have a unified design, which allow them to be combined with shelves and other items. It is easy to store, simply fold it in when not in use.

### | Cotton Linen Polyester Soft Box Storage |



#### Cotton Linen Polyester Soft Box - Half Size

[15003501] Extra Small	S\$9.90	[15003518] Small	S\$10.90
W12 x D37 x H12cm		W26 x D18.5 x H16cm	
[Not Washable]			



#### Cotton Linen Polyester Soft Box Square

[15003525] Small	S\$16.90	[15003532] Small With Lid	S\$20.90
W35 x D35 x H16cm		W35 x D35 x H16cm	
[Not Washable]			



#### Cotton Linen Polyester Soft Box

[18285044] Large	S\$20.90	[18285051] Large with Lid	S\$27.90
W35 x D35 x H132cm		W35 x D35 x H132cm	
[Not Washable]			



#### Cotton Linen Polyester Soft Box - Oblong

[18428847] Small	S\$13.90	[18428861] Medium	S\$16.90	[18428854] Medium With Lid	S\$20.90	[18428762] Large	S\$19.90
W37 x D26 x H16cm		W37 x D26 x H26cm		W37 x D26 x H26cm		W37 x D26 x H34cm	
*DO NOT WASH							



#### Cotton Linen Polyester Soft / Box Square

[15003532] S with Lid	S\$20.90	[15003525] Small	S\$16.90
Approx. W 35 x D 35 x H 16 cm		Approx. W 35 x D 35 x H 16 cm	
Convenient for organising kids' toys. Comes with a lid to keep dust from entering the box.		Convenient for organising kids' toys. The boxes can be folded for storage when not in use.	
[Not Washable]			

#### Cotton Linen Polyester Soft Box - Cloth Case

[18428779] Small	S\$27.90	[15003549] Large	S\$36.00
W59 x D39 x H18cm		W59 x D39 x H23cm	
[Not Washable]			



MUJI's Cotton Linen Polyester Storage Units are useful for keeping toys, clothes, and other small items.



Cotton Linen Polyester Soft Box / Rectangular / S when folded  
Sample use of Cotton Linen Polyester Soft Box / Clothes Case / S

## Stainless Steel Wire Basket

Wire baskets made from the strong and rust-proof stainless steel. Designed with handles for easy carrying. Can be stacked over one another when the holders are tucked inside the basket.



#### 18-8 Stainless Steel Wire Basket

[15117048] 2	S\$33.00	[15117055] 3	S\$39.00	[15117062] 4	S\$43.00
W37 x D26 x H8cm		W37 x D26 x H12cm		W37 x D26 x H18cm	
Tolerable weight: 5kg		Tolerable weight: 5kg		Tolerable weight: 5kg	
Allowed number of stacks: 2 stacks		Allowed number of stacks: 2 stacks		Allowed number of stacks: 2 stacks	
[A4]		[A4]		[A4]	



#### 18-8 Stainless Steel Wire Basket

[15117031] 1	S\$29.00	[15117079] 5	S\$49.00
W26 x D18 x H18cm		W 37 x D 26 x H 24 cm	
Tolerable weight: 5kg		Withstand load: 10kg, Stacking limit: 2 units	
Allowed number of stacks: 2 stacks			



Example of Use  
The basket is made of stainless steel and can be stacked when the handles are folded inside





## Acrylic Storage

Acrylic Storage Series allow easy identification of the contents stored. It is scratch resistant to maintain the beauty of the material. Available in a wide variety of shapes and sizes that fit your desk or even bathroom sink.



**Acrylic Case With Drawer - 2 Rows**  
**47380910** Small      **S\$23.00**  
 W17.5 x D13 x H9.5cm  
 Stackable with other similar sized acrylic storage items.



**Acrylic Case With Drawer - 2 Rows**  
**47380934** Large      **S\$39.00**  
 W25.5 x D17 x H9.5cm  
 Stackable with other similar sized acrylic storage items.



**Acrylic Case With Drawer - 2 Rows**  
**47380965** Small      **S\$23.00**  
 W17.5 x D13 x H9.5cm  
 Stackable with other similar sized acrylic storage items.



**Acrylic Case With Drawer - 2 Rows**  
**47380989** Large      **S\$39.00**  
 W25.5 x D17 x H9.5cm  
 Stackable with other similar sized acrylic storage items.



**Velour Inner Case - Longitudinal**  
**47381009**      **S\$9.90**  
 W16 x D12 x H2.5cm  
 Inner box for storing accessories and watches in the Acrylic Case With Drawer.  
 \*Two can be fitted into the large drawer.



**Velour Inner Case - 15 Partitions**  
**38373544**      **S\$16.00**  
 W16 x D12 x H2.5cm  
 Inner box for storing jewelry in the Acrylic Case With Drawer.  
 \*Two can be fitted into the large drawer.



**Velour Inner Case - 6 Partitions**  
**47266887**      **S\$16.00**  
 W24 x D16 x H2.5cm  
 Inner box for storing accessories and watches in the Acrylic Case With Drawer.  
 \*One can be fitted into the large drawer.



**Velour Inner Case - Ring**  
**38373551**      **S\$16.00**  
 W24 x D16 x H2.5cm  
 Inner box for storing jewelry in the Acrylic Case With Drawer.  
 \*One can be fitted into the large drawer.



**Acrylic Glasses Stand**  
**61174280**      **S\$39.90**  
 W6.7 x D17.5 x H25cm  
 Holds glasses and small items in four drawers. This storage item can be used upright or sideways.



**Velour Inner Case**  
**37353855**      **S\$9.90**  
 W5 x D16.5 x H2.5cm  
 \*Exclusively for Acrylic Glasses Stand.



**Acrylic Earrings & Necklace Stand**  
**18958207**      **S\$23.00**  
 W6.7 x D13 x H25cm  
 Perfect for hanging earrings and necklace. Transparent storage stand for easy identification of the contents stored.



**Velour Inner Case**  
**61155388**      **S\$9.90**  
 W5 x D12 x H2.5cm  
 Inner box for storing rings.  
 \*Exclusively for Acrylic Earrings & Necklace Stand.





**Acrylic Stand for Letter**

[15296224] **S\$9.00**  
 W5 x D13 x H14.1cm  
 A desktop stand convenient for storing envelopes and postcards.



**Acrylic Stand - Deep**

[61407876] **S\$23.00**  
 W17.5 x D13 x H9.5cm  
 Stackable drawer-type acrylic case. Convenient for storing small cosmetic items and toiletries.



**Acrylic Case**

[61485546] 3 Rows **S\$33.00**  
 W26 x D17.5 x H10cm  
 [15873128] 5 Rows **S\$46.00**  
 W26 x D17.5 x H16cm



**Acrylic Box 3 Drawers**

[8907589] 3 Drawers **S\$49.00**  
 [8907572] 6 Drawers **S\$59.00**  
 Can be used upright or sideways by changing the arrangement of inner plates.



**Acrylic Single Drawer Unit**

[61798196] **S\$29.00**  
 W25.2 x D17 x H8.7cm  
 Perfect for holding tiny miscellaneous items. Finished with high transparency acrylic material for easy identification of the contents stored.



**Acrylic 3 Drawer Unit**

[61798202] **S\$39.00**  
 W8.7 x D17 x H25.2cm  
 Finished with high transparency acrylic material for easy identification of the contents stored. Combine with other acrylic storage items for extra storage space.



**Acrylic Pen Stand**

[61479798] **S\$2.90**  
 W5.5 x D4.5 x H9cm



**Acrylic Pot**

[61479781] Small **S\$4.90**  
 Dia8 x H11cm  
 [61485584] With Lid **S\$5.90**  
 Dia8 x H11.5cm



**Acrylic Tissue Box**

[76226284] **S\$12.90**  
 W26 x D13 x H7cm



**Acrylic Stand with Partition - Half**

[61407869] Small **S\$9.90**  
 W17.5 x D6.5 x H4.8cm  
 [61407852] Large **S\$13.90**  
 W17.5 x D6.5 x H9.5cm  
 Stackable acrylic case perfect for storing small cosmetic items and toiletries.



**Acrylic Stand with Partition - Clear**

[61407838] **S\$19.00**  
 W17.5 x D13 x H9.5cm  
 Stackable with other similar sized acrylic storage items.



**Acrylic Stand with Partition - Half**

[61407845] Large **S\$29.00**  
 W25.8 x D17.5 x H6.1cm  
 Stackable acrylic case perfect for storing small cosmetic items and toiletries. Internal dividers can be removed to create more storage space.



**Acrylic Pen Stand**

[15296231] Small **S\$11.90**  
 W8.8 x D8.8 x H9.5cm  
 [15296248] Large **S\$16.00**  
 W13 x D8.8 x H9.5cm



**Acrylic Rack**

[15296286] Small **S\$19.00**  
 W8.8 x D13 x H14.2cm  
 [15296309] Large **S\$29.00**  
 W17.5 x D13 x H14.2cm



**Acrylic Partition Shelf**

[15919833] Small **S\$11.90**  
 W26 x D17.5 x H10cm  
 [15919840] Large **S\$13.90**  
 W26 x D17.5 x H16cm



**Acrylic Collect Box**

[61703671] 4x4 **S\$49.00**  
 W27.5 x D7.2 x H34.7cm  
 Uses non-transparent rear panel for better presentation of items.  
 Contents can be taken in and out from both front and back.



**Acrylic CD Stack Rack**

[76226277] **S\$23.00**  
 W13.5 x D27 x H15.5cm  
 Stackable CD rack. Holds about 25 CDs.



**Acrylic CD Rack - Box Type**

[76226253] **S\$19.00**  
 W17.5 x D13 x H14cm  
 Stackable CD box. Holds about 16 CDs.

## MDF and Polypropylene Storage Units

MUJI offers useful desktop storage units made from MDF as well as polypropylene boxes for organising A4-size documents. Select from a variety of types to suit your purposes.



**MDF Single Drawer Unit**  
 [76617945] S\$39.00  
 Approx. W 25.2 x D 17 x H 8.4 cm  
 Supplied with 1 partition  
 MDF, sliced ash veneer, lacquer coating  
 Useful size for organising desktop items. One partition is provided to separate the inside into compartments.



**MDF Organizer Box (A4 wide)**  
 [76316510] S\$39.00  
 Approx. W 32 x D 24 x H 10.5 cm  
 MDF, sliced ash veneer, lacquer coating  
 An organizer tray which accommodates A4-sized paper. This partition stand is useful for organising and sorting postcards, envelopes, and documents for circulation.



**MDF Storage Stand**  
 [61798066] A5 S\$26.00  
 Approx. W 8.4 x D 17 x H 25.2 cm  
 MDF, sliced ash veneer, lacquer coating  
 By using ash on the surface, the storage stand blends into any interior design. Perfect size to place on a desk for organising documents.



**MDF Drawer Unit**  
 [76617969] 6 Tier S\$59.00  
 [76617952] 3 Tier S\$49.00  
 Approx. W 8.4 x D 17 x H 25.2 cm  
 MDF, sliced ash veneer, lacquer coating  
 By using ash on the surface, the storage stand blends into any interior design. Drawers can be replaced so that the frame can be used vertically or horizontally.



**Cardboard File Box Set / 5 Pieces**  
 [15095094] A4 S\$12.90  
 Approx. W 10 x D 31.6 x H 24.6 cm



**Cardboard Stand File Box / 5 Pieces**  
 [15095087] A4 S\$12.90  
 Approx. W 10 x D 27.6 x H 31.8 cm



**Polypropylene Carry Box / Wide**  
 [15915453] S\$13.90  
 [37035508] White Gray  
 Approx. W 15 x D 32 x H 8 cm  
 Withstand load: Approx. 5 kg  
 Useful carry box for organising and carrying around tools and stationery. \*1



**Polypropylene File Box / Wide**  
 [76475965] A4 S\$13.90  
 [76475972] A4, White Gray  
 Approx. W 15 x D 32 x H 24 cm  
 This wide type file box can store up to two 50 mm wide double-hole files.



**Polypropylene File Box / Standard Type**  
 [15734528] A4 S\$11.30  
 [15556366] A4, White Gray  
 Approx. W 10 x D 32 x H 24 cm  
 Made of thick, solid plastic. This file box can also be stood on its side.



**Polypropylene Stand File Box / A4 Wide**  
 [61796895] A4 S\$13.90  
 [61796895] A4, White Gray  
 Approx. W 15 x D 27.6 x H 31.8 cm  
 This wide type file box can store up to two 50 mm wide double-hole files.



**Polypropylene Stand File Box**  
 [15318476] A4 S\$11.30  
 [15790821] A4, White Gray  
 Approx. W 10 x D 27.6 x H 31.8 cm  
 [37035669] Half S\$9.60  
 Approx. W 5 x D 27.4 x H 31.5 cm  
 Stores A4 and wide A4 size documents.



**Polypropylene Box / A4**  
 [61154909] 6 Drawers S\$36.00  
 [61164458] 3 Drawers S\$29.00  
 Approx. W 11 x D 24.5 x H 32 cm  
 The drawers are suitable for storing all sorts of items. The height is the same as that of file boxes, so they can be easily placed on a bookshelf. Drawers can be replaced so that the frame can be used vertically or horizontally.



\*1 Although identical products can be stacked, be careful of stacking too many units. (Up to 3 units is recommended) This item can also be stacked on the "Polypropylene File Box / Wide." As it cannot be secured, please take due care when using it stacked.

## ABS Resin Tray

MUJI trays help keep your desk organised by storing documents and stationery, as well as miscellaneous small items. Trays in the same series can be used in combination with each other.



**ABS A4 Tray with Legs**  
 [37328587] A4, with legs S\$23.00  
 Outside dimensions (with legs attached):  
 Approx. W 24 x D 32 x H 20.8 cm  
 (Tray portion): Approx. H 4.2 cm  
 Inside dimensions: Approx. 23.5 x D 31.5 x H 1.5 cm  
 Stackable number of units: 2 tiers  
 Total withstand load: 4.5 kg  
 This tray can be used as a shelf by attaching the included legs.



**ABS A4 Filing Tray**  
 [37328594] A4 S\$19.00  
 Outside dimensions: Approx. W 24 x D 32 x H 4.5 cm  
 Inside dimensions: Approx. W 23.5 x D 31.5 x H 4.2 cm  
 Stackable number of units: 3 tiers  
 Total withstand load: 9 kg  
 This tray is useful for keeping documents organised.



**ABS A4 Tray**  
 [37328600] A4 S\$19.00  
 Outside dimensions: Approx. W 24 x D 32 x H 4.5 cm  
 Inside dimensions: Approx. W 23.5 x D 31.5 x H 4.2 cm  
 Stackable number of units: 3 tiers  
 Total withstand load: 9 kg  
 The inside of this tray is divided into separate compartments.



**ABS Tray 1/2**  
 [37328617] A5 S\$13.00  
 Outside dimensions:  
 Approx. W 16 x D 24 x H 2.9 cm  
 Inside dimensions:  
 Approx. W 15.5 x D 23.5 x H 2.6 cm  
 Stackable number of units: 3 tiers  
 Total withstand load: 3 kg  
 The inside of this tray is divided into separate compartments.



**ABS Tray 1/4**  
 [37328891] A6 S\$11.30  
 Outside dimensions:  
 Approx. W 12 x D 16 x H 2.9 cm  
 Inside dimensions:  
 Approx. W 11.5 x D 15.5 x H 2.6 cm  
 Stackable number of units: 3 tiers  
 Total withstand load: 1.5 kg  
 The inside of this tray is divided into separate compartments.



**ABS Stand 1/8**  
 [37328938] S\$11.30  
 Dimensions:  
 Approx. W 8 x D 11 x H 8 cm  
 Inside dimensions:  
 Top: Approx. W 7.4 x H 8.2 cm  
 Bottom: Approx. W 7.4 x H 4.8 cm  
 The inside of this stand is divided into separate compartments for writing utensils and small office items.



**ABS Tray with Legs 1/2**  
 [37328945] A5 size, with 4 legs S\$16.00  
 Outside dimensions (with legs attached):  
 Approx. W 16 x D 24 x H 14.7 cm  
 (Tray portion): Approx. H 2.6 cm  
 Inside dimensions:  
 Approx. W 15.5 x D 23.5 x H 1 cm  
 Stackable number of units: 2 tiers  
 Total withstand load: 1.5 kg  
 This tray can be used as a shelf by attaching the included legs.

- \* Do not allow the resin material to come in contact with chemicals such as alcohol, oil, thinner, polish remover, strong acid, or strong alkali, as they may cause discoloration or deformation.
- \* To prevent scratches when cleaning, avoid using cleansers, abrasive powder, or hard materials such as scouring pads.
- \* Due to the characteristics of the material, stains or smudges may be visible on the surface when it is dirty.
- \* To clean the resin material, gently wipe with a soft cloth soaked in a neutral detergent diluted with 50% water.
- \* Do not use an acidic detergent for cleaning. Doing so may result in deformation.

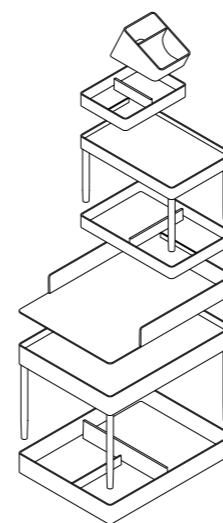

The items in this series are perfect for keeping your desk free of clutter.

These items can be stacked or used in combination with each other, enabling you to make more efficient use of the space on your desk. For smaller items, you can use trays that are divided into separate compartments, or you can attach legs to trays and use them as small shelves. These products are convenient when you do not have much to store, but want a place to put a few items.



Conveniently store pens and various desk items.



Stack three trays for A4 size documents to keep your magazines, catalogues, and documents organised.



Trays with legs make efficient use of space and keep small, miscellaneous items organized.

# Study Desk Working Chair

## | Structure of the Desk (system type) |

While being of a simple structure, these desks have excellent strength and can be used for a wide range of applications including use as a working desk or as a meeting table.



Desk (system type) combination price chart

	120 cm wide	150 cm wide
Top panel: Oak	S\$239.00	S\$279.00
Top panel: Melamine	S\$199.00	S\$249.00
Desk legs	S\$119.00	S\$139.00
Combination price (Top panel: Oak)	S\$358.00	S\$418.00
Combination price (Top panel: Melamine)	S\$318.00	S\$388.00



\* Withstand load of top panel: Oak, white melamine: 40 kg



## Working Chair

[18121298] Gray [18121304] Black S\$199.00

W 55.5 x D 53 x H 74-84  
(height of seat surface: 39-49) cm  
Outer shell: 100% polyester  
Frame: steel, polyester powder coating



## Working Chair Arm / Pair

[18121861] Gray [18121878] Black S\$43.00

When armrests are attached:  
W 57 x D 53 x H 74-84 cm  
Outer shell: 100% polyester  
Frame: steel, polyester powder coating



When armrests are attached

These desks make use of natural-grain wood, making them ideal for writing or studying. System type desks are available with optional parts that enable you to customise the configuration, making them perfect for a wide range of applications. Height-adjustable chairs that can be used with attachable armrests are also available.

## | Top panel, Legs |

The top panel is available in the two materials of oak and melamine.



### Desk Top Panel / Oak

[37526464] Width 150cm S\$279.00

W150 x D60 x thk. 2cm

[37526426] Width 120cm S\$239.00

W 120 x D 60 x thk. 2 cm  
MDF, oak veneer, UV-cured coating



### Desk Top Panel / Melamine / White

[37526389] Width 150cm S\$249.00

W150 x D60 x thk. 2cm

[37526341] Width 120cm S\$199.00

W 120 x D 60 x thk. 2 cm  
MDF, melamine finish



### Desk Legs / Steel / Light Gray

[15914555] S\$139.00

W 150 x D 60 x H 72 cm

[15914562] S\$119.00

W 120 x D 60 x H 72 cm  
(Dimensions when legs are combined with the top panel)  
Steel, epoxy powder coating

## | Optional Parts |

Optional parts which can be combined with the Desk.



### Steel Cabinet / Light Gray

[18121236] S\$339.00

W 39.5 x D 53.5 x H 62.5 cm (with handle)

Inside dimensions of drawer:  
(Top/middle) W 32 x D 41 x H 7 cm  
(Bottom) W 32 x D 41 x H 15 cm

Withstand load:  
15 kg for top panel, 2.5 kg for top and middle drawer, 5 kg for bottom drawer

Steel, epoxy powder coating  
With key and casters



### Partition for Desk / Light Gray

1 [15914579] S\$89.00

W 86 x D 6.5 x H 34 cm (Height when partition is attached to desk: 31.5 cm)

Steel, epoxy powder coating



### L-Shaped Shelf for Desk with Magnet / Light Gray

2 [15914586] S\$33.00

W 30 x D 12 x H 12 cm

Steel, epoxy powder coating

## Oak Desk with Drawers

[15874781] S\$409.00

W110 x D55 x H70cm



## Oak Desk Cabinet

[15874804] S\$289.00

W35 x D48 x H56cm



### More Backward Arm Position

Arms were positioned more backward for easy elbow resting during relax time.



### Lower Seat Height

Seat height is made lower for the users that are small in size and users who do not wear shoes in the room.



### Sophisticated Rear View

Bolts on the back rest are made invisible for a more sophisticated appearance.



### Round Finished Legs

Legs are finished with a roundish shape to avoid hurting the bare foot of the user.

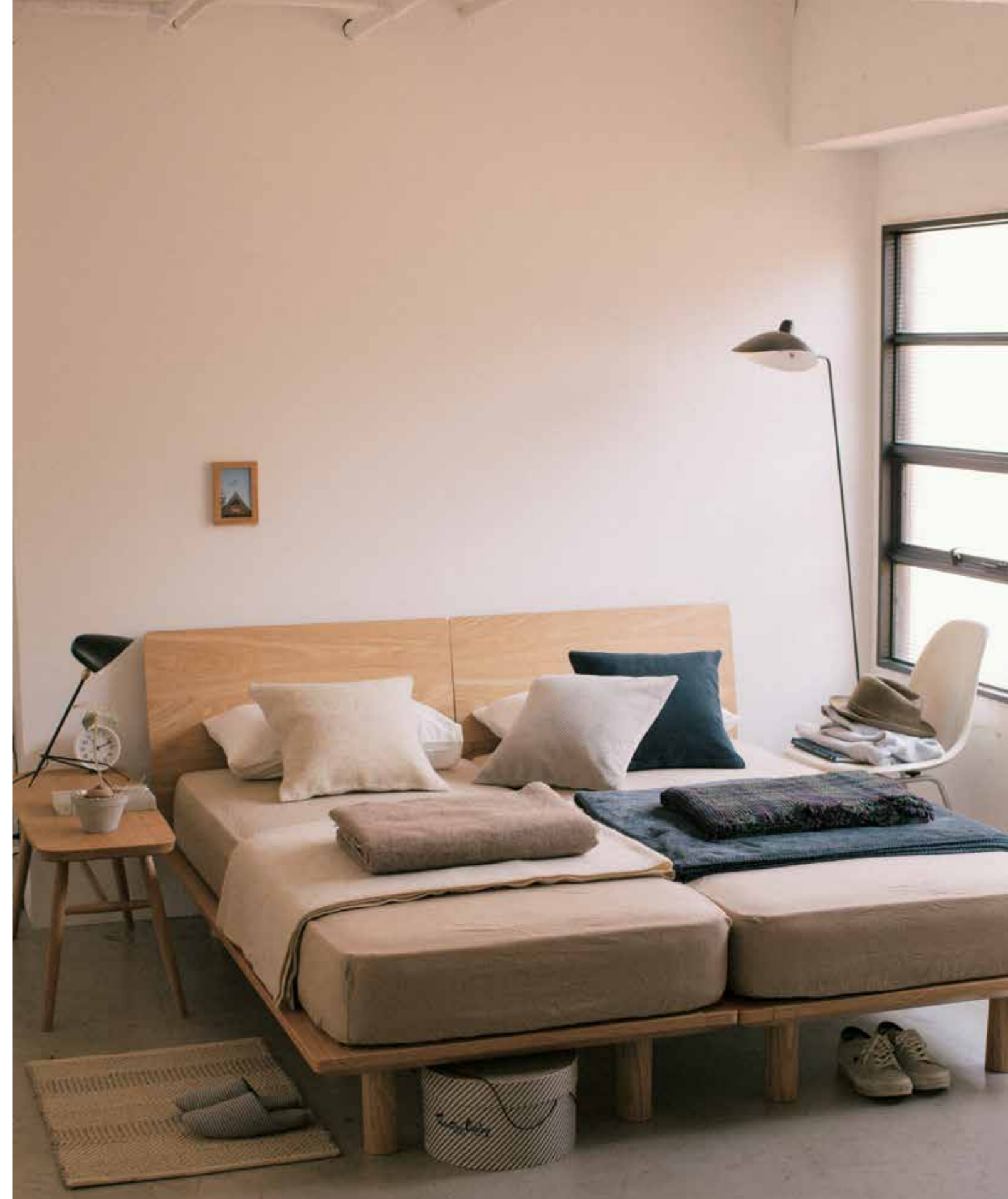

# Bedding

# Wooden Bed Frame

The low-profile frames create a simple bed design with a cosy feel. By moving the belts attached to the wood springs, you can adjust the firmness to your preference. Available in oak and walnut.



## Your original bed frame

People wish for uniquely different characteristics in beds, which is natural for equipment that people share the most time with. More storage space, using two single sizes side-by-side, a rounded design to protect the body from injuries, and airiness, to name a few preferences.

MUJI's bed frames are born from such customer feedback. The firmness/softness of the bed can be adjusted by moving the belts on the wood springs. The headboard is designed so that two beds can be seamlessly placed next to each other. The bed frame provides space underneath for storage. MUJI developed its new bed for the comfort of users during sleep and in daily life.

### 1 Headboard

The angle of the headboard is adapted to give comfort and relaxation. One way of enjoying a bed is reading before bedtime while leaning against the headboard.

### 2 Wood springs

The wood springs add a cushioning effect along with the mattress, dispersing the body pressure and reducing the load on the back and hips. This function of the wood springs also extends the life of the mattress. By changing the positions of the belts attached to the wood springs, you can arrange the firmness to your best sleeping comfort.

### 3 Legs

The supplied legs can be removed to use the bed placed directly on the floor.

### 4 Storage

Space beneath the bed can be effectively used by installing a large capacity storage unit under the bed frame. This space can be partitioned according to the items, which can include large fabrics such as heavy towels to smaller frequently-used commodities.

### 5 Mattress

MUJI provides a selection of mattresses that offer 3 different types of sleeping comfort.

## How to adjust the wood springs

Moving the belts attached to the wood springs toward the outside makes the wood springs softer while moving the belts toward the inside makes the wood springs more rigid. You can customise your bed comfort, for example, by making the lower back part firmer and the other parts softer using the adjuster belts. Adjust the wood springs to your preference before placing the mattress.

\* A pair of belts should be placed symmetrically at an even distance from the centre.

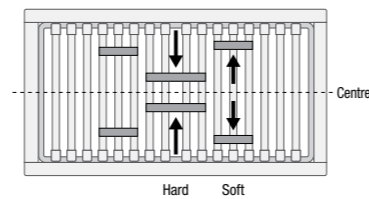

### Wooden Bed Frame

1	37285453 Oak / Single W103 x D202 x H25.5cm	S\$469.00
	37285477 Oak / Double W147 x D202 x H25.5cm	S\$629.00
3	37285491 Walnut / Single W103 x D202 x H25.5cm	S\$549.00
	37285514 Walnut / Double W147 x D202 x H25.5cm	S\$709.00



### Wooden Bed Headboard

2	37285538 Oak / Single W103 x D8 x H53cm	S\$189.00
	37285552 Oak / Double W147 x D8 x H53cm	S\$289.00
	37285583 Walnut / Single W103 x D8 x H53cm	S\$239.00
	37285606 Walnut / Double W147 x D8 x H53cm	S\$339.00



### Wooden Bed Storage Box - Large

4	37285620 Oak	S\$189.00
	37285637 Walnut W80 x D90.5 x H19cm	S\$229.00



### Wooden Bed Storage Box

5	37285644 Oak	S\$159.00
	37286139 Walnut W80 x D60.5 x H19cm	S\$189.00





## Oak Bed

MUJI's easy-build oak beds feature a beautiful wood pattern. The basic design never loses its lustre. The frame uses robust laminated lumber.



\*Combination example: Mattress is sold separately.

### Oak Bed

37285248 Single	S\$699.00
W100 x D202 x H74cm	
37285279 Queen	S\$1199.00
W60 x D202 x H74cm	
37285286 King	S\$1399.00
W103 x D202 x H25.5cm	



It is designed at an slant angle for our body to lean comfortably against it. The bed frame is also wider and thicker to increase stability.



The lower crosspiece of the headboard has a depth that allows you to put clocks and other items on the crosspiece.



### Materials are carefully selected for your long-term use.

The square wood pieces used for the Oak Bed legs are produced by pasting together three 1-inch (approx. 2.5 cm) wood boards that are commonly available to make a square block. This way, resources are economically and efficiently used, which also contributes to reasonable prices. MUJI's beds, made with durable materials, can be used for a long time.

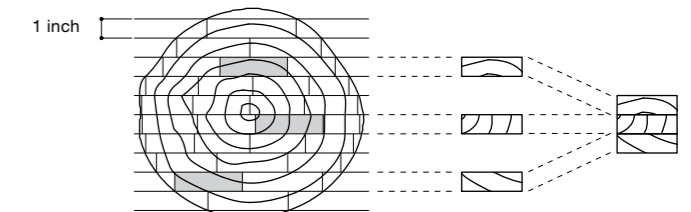

Wood boards are pasted together to make a stronger, square block.

- ◆ To ensure the long term use of your bed frame, please use a bed mattress that provides superior body weight distribution. (When using a futon mattress on a bed frame, your body weight is applied directly to bed board, which can eventually lead to problems such as cracked bed board.)
- \* Due to the use of natural wood, the colour of each product may slightly vary. The colour may also appear different under different lighting.
- \* Due to the nature of the material, oak may have a unique pattern which is referred to as a "tiger grain." \* The characteristics of natural wood, such as the colour and grain pattern, may vary in appearance depending on the material.



## Storage Bed

A bed with an under-bed storage equivalent to the storage of 2 units of 4-tier wide chest drawers. Suitable to store everyday clothing or even larger items such as suitcases or futon mattresses.



Additional Box

With wooden spring base removed.  
\*There is no base board under the open space as shown.

[Storage Area] Double Bed

### 4 Tier Wide Chest with storage power of 2 combined units.

For a more effective storage in rooms, we have relooked into under-bed storage designs. Using storage box itself to support the mattress, more storage space is now available.



\*Combination example: Mattress is sold separately.

#### Storage Bed - Oak

[37407947](#) / Single  
W105.5 x D201 x H27cm

S\$559.00

[37407961](#) / Double  
W148.5 x D201 x H27cm

S\$719.00



#### Storage Bed - Walnut

[37407985](#) / Single  
W105.5 x D201 x H27cm

S\$639.00

[37408005](#) / Double  
W148.5 x D201 x H27cm

S\$759.00



#### Storage Bed Additional Box - Oak

[37416659](#) Single  
W105.5 x D15 x H27cm

S\$149.00

[37416673](#) Double  
W148.5 x D15 x H27cm

S\$179.00



#### Storage Bed Additional Box - Walnut

[37416925](#) Single  
W105.5 x D15 x H27cm

S\$169.00

[37416949](#) Double  
W148.5 x D15 x H27cm

S\$199.00



## Bonnell Coil Mattress

The mattress focuses on the inner layer such as spring coils. Bed pads are washable to maintain cleanliness. Available in various types.



Muji refocuses on the structure of the mattress that is defined for a greater comfort and body support as desired. The frame material is now changed from wood to steel in order to enhance breathability and durability. Now, removing the cover is simple; thus makes washing easy for a longer period of usage.

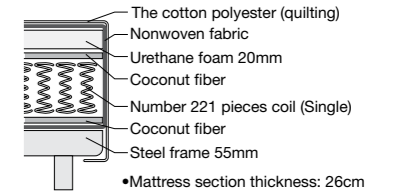

•Mattress section thickness: 26cm

### Simple Classic Bed

#### 1. Cover

Changing the cover is simple. With periodic washing, the cover can be kept clean. The cover can be removed and machine-washed.

#### 2. Spring Unit

MUJI mattress uses bonnell coils. It is covered in non-woven fabric so the unit can be changed easily when necessary.

#### 3. Steel Frame

The strength of the mattress is reinforced by changing the frame from wood to steel.

#### 4. Wooden Legs in Natural Wood

Choose from two different heights to suit your preference.

Height: 20cm / 26cm



Mattress - Single

[37497788](#)  
W98 x D198 x H26cm

S\$309.00



Legs for Mattress - Set of 4pcs

[47462203](#) H20cm  
[15296972](#) H26cm

S\$33.00  
S\$39.00

### The cover (outer cloth) and spring unit can be replaced.

The legs, steel frame, and coil unit can be separated; the cover (outer cloth) with Velcro tape encompasses them. The parts are also available separately. Environmental stress can be reduced by only replacing the worn parts and sorting the parts when disposing.

\*Replacement parts for the steel frame are not available.



### Rotate the mattress for longer life

Switch the head side and feet side every season. The strength of springs may deteriorate if a load is continuously applied at the same point. By changing the mattress orientation and distributing your body weight more evenly over time, you can reduce the load on the springs. Make sure to periodically air out the mattress by letting it stand on its side. Moisture may build up inside the mattress if it is always kept on the bed frame, possibly leading to the formation of mould.

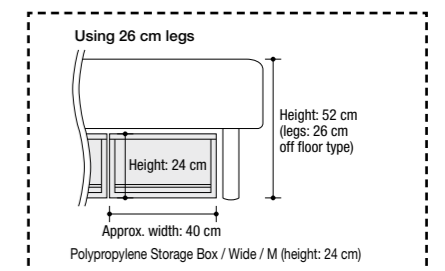
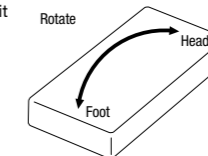

## Mattress, Bed Pad

The mattress focuses on the inner layer such as spring coils. Bed pads are washable to maintain cleanliness. Available in various types.



### More spring coils, higher stability for a good sleep posture.

The increased number of coils enables the mattress to more evenly distribute your body weight, reducing the pressure on your spine and lower back. The coils work together to conform to the shape of your body, providing a well-balanced and stable posture for longer periods of time.

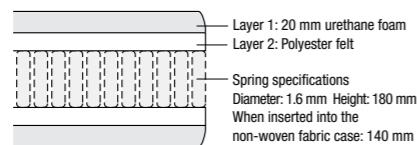

#### High Density Pocket Coil Mattress

[15783724] Single	S\$799.00
W97 x D195 x H19cm	
[15783748] Double	S\$1199.00
W140 x D195 x H19cm	
[15783755] Queen	S\$1499.00
W160 x D195 x H19cm	



### Stand-alone coils provide point-support to the body.

This mattress is constructed with a dense arrangement of independent coils that function as numerous points to absorb your body weight and provide well-balanced support. The mattress ensures a stable posture and reduces the amount of shakiness and sinking.

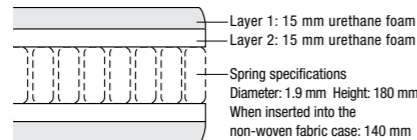

#### Pocket Coil Mattress

[18094844] Single	S\$499.00
W97 x D195 x H19cm	
[18094868] Double	S\$799.00
W140 x D195 x H19cm	
[61863351] Queen	S\$999.00
W160 x D195 x H19cm	
[61854182] King	S\$1199.00
W180 x D195 x H19cm	



### The high resilience provides a steady support to the body.

This mattress features an interlocking design of hourglass-shaped springs that firmly support your body weight across the entire surface. The mattress uses Bonnell coil springs, which are currently the most prevalent and reliable type of mattress coil in use.

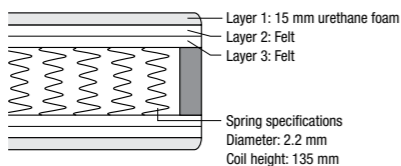

#### Spring Mattress

[15901838] Single	S\$239.00
W97 x D195 x H18cm	
[15901852] Double	S\$399.00
W140 x D195 x H18cm	



#### Polyester Bed Pad with Elastic

[37288157] Single	S\$56.00
100 x 200 cm Wadding weight: 0.80 kg	
[37288171] Double	S\$83.00
140 x 200 cm Wadding weight: 1.12 kg	
[37288188] Queen	S\$99.00
160 x 200 cm Wadding weight: 1.28 kg	
Outer shell: 52% cotton, 48% polyester	
Wadding material: 50% cotton, 50% polyester	
[Machine washable (in mesh bag)]	
Elastic bands hold the mattress pad securely in place.	

## Futon, Pillow

For sleeping comfort, our bedding has been developed to focus on materiality and functionality. Select your ideal bedding from our wide range of variety.



#### Profile Urethane Foam Cutting Futon

[37288249] Single	S\$289.00
-------------------	-----------

100 x 200 cm Padding weight: 3.0 kg  
Outer shell: 85% polyester, 15% cotton  
Wadding/padding: urethane foam

Cutting the urethane foam to create protrusions and recessions creates a comfortable futon mattress which supports the body at points. The outer shell can be taken off for washing which enables clean use.



\* Please handle this product upon referring to the manual provided with your washing machine. (It may not be possible to wash this item depending on the capacity of your washing machine.)

\* The padding and urethane foam cannot be washed.



#### Wool Polyester Quilted Futon

[37107854] Single	S\$189.00
-------------------	-----------

W100 x L210cm  
Fabric: 100% Cotton  
Filling: 50% Wool, 50% Polyester  
Solid Cotton: 100% Polyester



#### Polyester Hard Mattress For Futon

[18387403] Single	S\$93.00
-------------------	----------

W95 x D210 x H4cm  
Fabric: 50% Polyester, 50% Cotton  
Filling: 100% Polyester

\*Do not wash



#### Feather Pillow

[15828494]	S\$19.00
------------	----------

43 x 63cm

[15808500]	S\$23.00
------------	----------

50 x 70cm

Made with lightweight feathers, the pillow feels soft and does not sink easily providing comfort for a good sleep.



#### Urethane Foam Low Repulsion Pillow

[337-750364]	S\$33.00
--------------	----------

43 x 63cm

This pillow is made from low and high repulsion urethane which provides extreme comfort on your neck and head.



#### Urethane Foam Low Repulsion Molded Pillow

[15828524]	S\$79.00
------------	----------

43 x 63cm

Uses low repulsion urethane mould which exerts a small change in its hardness caused by the change of temperature. Features extreme comfort for your neck and head.

\*Regularly let the mattress stand off the floor to ventilate it. Leaving the mattress over a long period on the floor may cause the formation of moulds.



# Sofa

## Living Dining Table & Chair

Living in comfort in a compact space. Embracing the unity of two spaces catering to relaxation, dining or both. With the right furniture, a living and dining area can live beautifully within the same walls.



Side of Depth 65cm



Side of Depth 80cm

### Living Dining Table

- 1 [15253845] Table 1 / Depth 65cm W150 x D65 x H60cm S\$649.00
- 2 [15253852] Table 2 / Depth 65cm W130 x D65 x H60cm S\$569.00
- [37145481] Table 3 / Depth 80cm W150 x D80 x H60cm S\$889.00

• Only for Special Order.



### Living Dining Bench

- 3 [15257058] Bench 1 W158 x D46 x H40.5cm S\$399.00
- 4 [15257065] Bench 2 W58 x D46 x H40.5cm S\$239.00



### Living Dining Sofa Chair

- [15253722] Chair W55 x D78 x H77cm S\$399.00
- 6 [15549597] Connecting Plate / Set of 2 pieces S\$16.00
- 5 [15253739] Arm Set Set of 2 pieces S\$49.00



### AV Rack / Slim Type

- 4 [38318347] Width 150cm W 150 x D 35 x H 36.5 cm S\$549.00
- 5 [37153653] Width 110cm W 110 x D 35 x H 36.5 cm S\$469.00

An AV Rack with a compact height and depth. This rack has also been designed with sliding doors in the rear panel for easy wiring.  
 \* While the 150 cm-wide type can be used with a supplementary leg, please be sure to attach the supplementary leg when placing objects that weigh more than 20 kg on the top surface.  
 \* The supplementary leg is not included with the 110 cm-wide type.

Main unit: flush structure, oak veneer (outer side), decorative oak veneer (inner side / bottom)  
 Movable shelf: particle board, decorative oak veneer  
 Legs: LVL, oak veneer  
 Paint: urethane resin coating  
 Withstand load: 40 kg for top surface, 14 kg for shelf



An AV rack with a compact height and depth. This rack has been designed with sliding doors in the back panel for easy wiring.  
 \* With the 150 cm-wide type, please be sure to attach the supplementary leg when placing objects that weigh more than 20 kg on the top surface.  
 \* The supplementary leg is not included with the 110 cm-wide type.

a \*All covers sold separately. Kindly refer to page 57 for cover selection.



## Wide Arm Sofa

One can choose a comfort of their liking from selected feather with pocket coils, and urethane. Parts can be replaced which enables use over many years.

### | Feather Pocket Coil Cushion |

The sofa is a coupled-effect of the soft feather cushioning and the assuring stability of the pocket coils.



Sofa Body - 2.5 Seater

37408135

W190 x D87.5 x H75cm

S\$1099.00



The feather and pocket coil combination sofa sort of wraps one's body when sat on. The back rest has a soft feather cushiony feel while the sofa seat itself has a sturdy and soft coil-feather feel.



Back rest: Urethane + Feather



Seat: Pocket Coil + Feather

A design made for relaxation.

### Ottoman / Feather Cushion (Large Ottoman)

37408104 + Legs: Natural/brown

W 77 x D 54.5 x H 40 cm (with legs attached)

S\$369.00

The addition of the "Large Ottoman" with the "Sofa" makes use possible as not only an ottoman but also a compact 1 seater or use of the regular sofa as a couch sofa. Greater variation in combinations increase the range of how the sofa can be used which makes it perfect for use over many years.

\* The legs can be selected from either natural or brown.

### | Urethane Foam Cushion |

A slightly sturdy sofa that eases the movement of getting up and seating. The cushion softens up to the body after frequent use.



Sofa Body - 2.5 Seater

47276985

W190 x D87.5 x H75cm

S\$699.00



A combination of a very sturdy seat and urethane cushion, this sofa uses a just-right urethane hardness to create the needed stability for seating. The sturdy urethane back rest and seat is not too soft which provides a great support to the body.



Back rest: Urethane



Seat: Urethane



Headrest

76580690 W77cm for 2.5 Seater

S\$89.00

Body: Urethane foam, feather, steel

Simply attaching the headrest will convert the "Sofa" into a high-back sofa to lean on. Be sure to use this item with the separately sold cover.

\* The headrest unit cannot be installed on the older models of "Wide arm sofas (2007)" and "Sofa units (2005)."

Ottoman

47276916

W54.5 x D35 x H35cm

S\$129.00



### | Additional Parts |

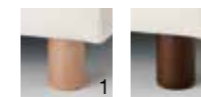

Legs for Sofa / Ottoman

1 47277029 Natural

S\$33.00

2 47277036 Brown

S\$33.00

H10cm

\*All covers sold separately. Kindly refer to page 57 for cover selection.

## Unit Sofa

A sofa that can be freely combined to suit different lifestyles and spaces. Assembly is easy with free combinations where the armrests can be attached to either side. With an eye on comfort, molded urethane which keeps its shape has been used for the interior.



With Armrest		Armless		Ottoman		Box	
[15815159] Large	S\$489.00	[15815166] Large	S\$399.00	[15815173] Large	S\$319.00	[76580577] Shelf	S\$239.00
W95 x D82 x H66cm		W74 x D82 x H66cm		W74 x D61 x H37cm		W75 x D32 x H41cm	
[15815180] Small	S\$399.00	[15815197] Small	S\$319.00	[15815203] Small	S\$289.00	A shelf that perfectly accommodates upright A4-sized file boxes and can also be used as an arm rest.	
W82 x D82 x H66cm		W61 x D82 x H66cm		W61 x D61 x H37cm		[76580584] Table	S\$319.00
The armrest can be switched to either side.						W59 x D75 x H32cm (2 compartments in front and back) MDF, ash veneer, lacquer coating A table with two storage compartments in the front and back which perfectly accommodate storage items by MUJI.	

\* The Unit Sofa series shown in the photo is covered with the grey beige plain weave polyester cover (sold separately).  
\* Be sure to use this item with the separately sold cover.

## Sofa Chair Cover

Pick a cover that best suits your home. Choose from the different colours and materials in the selection below.

Cover		Cotton	Cotton Polyester		Cotton Chenille		
		Dark Brown	Beige	Brown	Light Grey	Green	Charcoal Grey
Wide Arm Sofa	2.5 Seater	[18531967] S\$249.00	[18022182] S\$369.00	[18022168] S\$369.00	[61048499] S\$369.00	[61048369] S\$369.00	[61048239] S\$369.00
	Ottoman	[18532025] S\$49.00	[18022069] S\$63.00	[18022052] S\$63.00	[61048543] S\$63.00	[61048413] S\$63.00	[61048284] S\$63.00
Unit Sofa [August]	With Armrest L		[15435777] S\$229.00	[15439072] S\$229.00	[15449118] S\$229.00	[15453351] S\$229.00	
	With Armrest S		[15435807] S\$209.00	[15439102] S\$209.00	[15449149] S\$209.00	[15454303] S\$209.00	
	Armless L		[15435784] S\$209.00	[15439089] S\$209.00	[15449125] S\$209.00	[15454280] S\$209.00	
	Armless S		[15435814] S\$179.00	[15439119] S\$179.00	[15449156] S\$179.00	[15454464] S\$179.00	
	Ottoman L		[15435791] S\$179.00	[15439096] S\$179.00	[15449132] S\$179.00	[15454297] S\$179.00	
Living Dining Series	Sofa Chair		[15435845] S\$99.00	[15439140] S\$99.00	[15256471] S\$99.00	[15256488] S\$99.00	
	Bench 1 [July]		[15435852] S\$79.00	[15439157] S\$79.00	[15257096] S\$79.00	[15257102] S\$79.00	
	Bench 2		[15436705] S\$49.00	[15439164] S\$49.00	[15257133] S\$49.00	[15257140] S\$49.00	

• Only for Special Order.

Free combinations allow these sofas to be used not only as a compact sofa but also as a sofa set in a large living room.



Unit Sofa / With Armrest / Small x 1  
Unit Sofa / Armless / Small x 1

Unit Sofa / With Armrest / Large x 1  
Unit Sofa / With Armrest / Small x 1  
Unit Sofa / Armless / Small x 1

Unit Sofa / With Armrest / Small x 2  
Unit Sofa / Armless / Large x 3  
Unit Sofa / Armless / Small x 2  
Unit Sofa Ottoman / Large x 1  
Unit Sofa Box / Shelf x 1

\*All covers sold separately. Kindly refer to page 57 for cover selection.

## Beads Cushion

Flexible sofa that freely moulds its shape to your sitting preference with ultra micro beads and stretchable cover that wraps your body in comfort.



Beads Cushion	
61049182	S\$169.00
W65 x D65 x H43cm Weight: Approx. 6 kg	
Beads Cushion Cover	
1 61048888	Grey Beige S\$49.00
2 61048871	Dark Brown S\$49.00
3 37137516	Coral Pink S\$49.00
4 37287594	Charcoal Grey S\$49.00
5 76580294	Navy S\$49.00
6 37100619	Denim/Navy S\$79.00
7 37287600	Denim/Hickory S\$79.00
8 37845602	Cotton chino/khaki S\$79.00
9 37497771	Chino/Olive drab S\$79.00
W65 x D65 x H43cm	

Ultra micro beads of approximately 0.5mm are resistant to deformation which provides an extra soft sitting comfort.

### When placed on its side

Wraps your body from waist till neck and keeps you in your favourite posture. Ideal for reading and watching television.

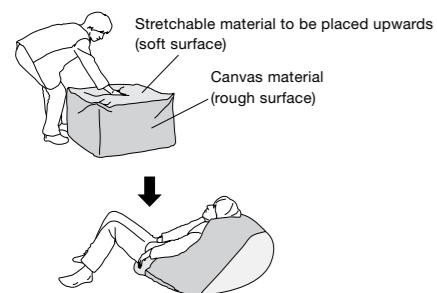

### When placed upright

Sinks and widens in all directions making it comfortable when resting.

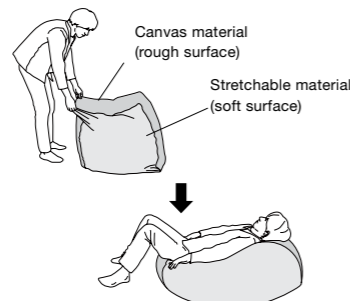

## Reclining Sofa

The reclining sofa which pursues relaxing comfort on which one can lay their body has been modified to allow a cover of your choice.

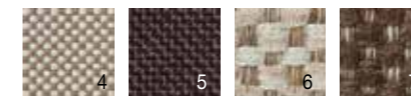

Highback Reclining Sofa (Cover) - 2 Seater	
4 37156784	Cotton Beige S\$339.00
5 37156913	Cotton Dark Brown S\$339.00
6 37157309	Cotton Polyester Beige S\$429.00
7 37157392	Cotton Polyester Brown S\$429.00

Highback Reclining Sofa (Cover) - 1 Seater	
4 37154681	Cotton Beige S\$229.00
5 37154698	Cotton Dark Brown S\$229.00
6 37155411	Cotton Polyester Beige S\$289.00
7 37155428	Cotton Polyester Brown S\$289.00

Highback Reclining Sofa (Cover) - Ottoman	
4 37158061	Cotton Beige S\$49.00
5 37158122	Cotton Dark Brown S\$49.00
6 37158207	Cotton Polyester Beige S\$79.00
7 37158214	Cotton Polyester Brown S\$79.00

### High back design offering greater support up to the head

The high back design allows you to lie back and relax on the sofa. The cushions gently support your body right up to the neck position.

### With reclining function

The reclining function of this chair is for both the backrest and the headrest, which allows you to adjust the sofa to your desired angle. The backrest is adjustable to six positions by the lever; and the headrest can be adjusted to six positions, even when the sofa is laid flat.

### With reclining function

The cushions are made with soft and fluffy feathers to provide an exceptional sitting comfort. Urethane chips are mixed with feathers to enhance cushion resilience. The cover is detachable from the cushion body. If wrinkles are observed on the sofa surface, remove the cover and knead the cushion to puff it up.



# Tables & Chairs

## Wood Tables and Chairs

Enjoy every meal and tea-time. The joy in our everyday life begins when we gather around the table.



**Oak Extension Table**  
 [15877553] S\$799.00  
 W140-190 x D80 x H72cm  
 Tolerable weight: 40kg, extension plate: 10kg



**Oak Bench**  
 [15892419] S\$309.00  
 W100 x D37 x H44cm  
 Tolerable weight: Middle shelf 10kg



**Oak Side Table Bench**  
 [15892341] S\$159.00  
 W37 x D37 x H44cm  
 Tolerable weight: 15kg



**Oak Table 180cm**  
 [15892402] S\$1199.00  
 W180 x D80 x H72cm  
 Tolerable weight: 40kg



**Oak Table 140cm**  
 [15892396] S\$939.00  
 W140 x D80 x H72cm  
 Tolerable weight: 40kg



**Pinewood Foldable Table**  
 [18499441] High S\$99.00  
 W80 x D50 x H70cm  
 [18499434] Low S\$89.00  
 W80 x D50 x H35cm  
 Tolerable weight: 15kg



When Folded Back



**Oak Solid Wood Table Bench**  
 [15892426] S\$739.00  
 W120 x D37.5 x H44cm  
 Tolerable weight: Storage 20kg



Example of Use

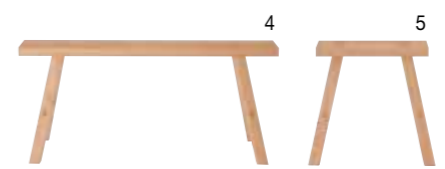

**Oak Solid Wood Bench**  
 4 [15892358] Large S\$189.00  
 W100 x D30 x H44cm  
 5 [15892365] Small S\$159.00  
 W45 x D30 x H44cm



**Oak Chair With Beige Seat**  
 [15892372] Natural S\$249.00  
 W38 x D48.5 x H79cm



### North American white oak series

By establishing a sustainable material supply route through efforts with areas where raw materials are produced, we have been able to create reasonable furniture that can be used for a long time.



### Oak

As used for furniture and whiskey barrels from back in the day, oak which is hard, solid, and durable is a perfect material for furniture to be used for a long time. The delicate and soft expression creates furniture having a relaxed look. Patterns referred to tiger grain which resemble the striped pattern of a tiger and its delicate and gentle grain are characteristics of oak. The look of oak is enhanced as the material ages over time.



### Walnut

Walnut has been in use for furniture and decorations from old times and is precious wood famous throughout the world and still used for high quality furniture and crafts. Walnut is characterised by its beautiful grain and minimal change in dimensions. As this wood contains a decent amount of oil, the wood has a gloss to it. Its unique texture is increased as people touch and use the items. This material allows one to enjoying how the material ages over time. This wood is a material that is sought after as one of the three best precious woods alongside cheek and mahogany.

## Low Table

Use this U-Shape furniture as an informal table that can be used throughout the year as a low table. Now available in square, rectangular and even oblong designs.



Ash Plywood Oval Table

[47549256]	W140cm	S\$599.00
W140 x D79 x H35cm		
1	[47549263]	W110cm
W110 x D62 x H35cm		
Tolerable weight: 40kg		



Oak Low Table

[15880850]	S\$569.00
W120 x D60 x H35cm	
2	[15880843]
W90 x D60 x H35cm	
[15880836]	S\$399.00
W90 x D45 x H35cm	
Tolerable weight: 40kg, 5kg per drawer	



With Cover

Side

Without Cover

Legless Chair (Body) - Large

[18481286]	S\$79.00
W57 x D102 x H10cm	

Legless Chair (Body) - Small

[18481293]	S\$59.00
W46 x D86 x H10cm	

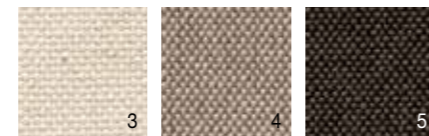

Legless Chair (Cover) - Large

3	[37746886]	Canvas Ecru	S\$39.00
4	[15999057]	Cotton Beige	S\$43.00
5	[15999699]	Cotton Brown	S\$43.00

Legless Chair (Cover) - Small

3	[37746930]	Canvas Ecru	S\$29.00
4	[15999064]	Cotton Beige	S\$33.00
5	[15999705]	Cotton Brown	S\$33.00



Ash Multi-Purpose U-Shape - W70cm

[18121656]	Natural	S\$139.00
[18121670]	Brown	S\$139.00
W70 x D30 x H35cm		
Tolerable weight: 40kg when used as a shelf		



Ash Multi-Purpose U-Shape - W35cm

[18121663]	Natural	S\$109.00
[18121687]	Brown	S\$109.00
W35 x D30 x H35cm		
Tolerable weight: 40kg when used as a shelf		



## | Beech Wood Series |

Muji uses high quality beechwood from Europe. Since the pressing of beech requires easy strength, it has been a popular furniture material for a long time in Europe.



When Folded

Beech Folding Chair Wooden Seat Plywood

[37167117]	S\$99.00
W45.5 x D52.5 x H79.5cm	

Beech Low Table Round

[15902217]	S\$209.00
W459.5 x D59.5 x H35cm	



Beech Compact Table

[15120109]	S\$289.00
W75 x D40 x H70 cm	



## HOME DELIVERY

Delivery Time	Delivery charges for purchases below S\$500	Delivery charges for purchases above S\$500
<b>Monday - Friday</b>		
10:00am - 7:00pm	S\$40	Free
7:00pm - 9:00pm	S\$60	S\$20
<b>Saturday</b>		
10:00am - 7:00pm	S\$60	S\$20

No deliveries on Sunday and Public Holidays.  
Labour charge for walk-up apartment is at S\$10 per level.  
Delivery service is based on single destination within Singapore only.

No assembly charges will be required on the first delivery, for subsequent request, assembly charge of \$8 per item will be applicable.

Stock availability and delivery charges vary for online and in-store. Kindly visit our webpage ([www.muji.com/sg/store](http://www.muji.com/sg/store)) for more information.

Please approach our staff for further enquiries.

MUJI (SINGAPORE) Pte Ltd reserves the right to amend the above Terms & Conditions without prior notice.