



# Furniture Catalogue

**MUJI**  
無印良品

# 2017 Furniture Catalog

<b>Storage</b>	<b>4</b>	Storage Furniture	6
		Storage Items	42
		Desk Storage	58
<b>Bedding</b>	<b>66</b>	Bed	68
		Mattress, Bed Pad	78
		Pillow, Futon	82
<b>Sofa</b>	<b>90</b>	Sofa	90
		Sofa / Chair Covers	102
<b>Tables &amp; Chairs</b>	<b>110</b>	Tables / Chairs	110
		Desks / Working Chairs	118

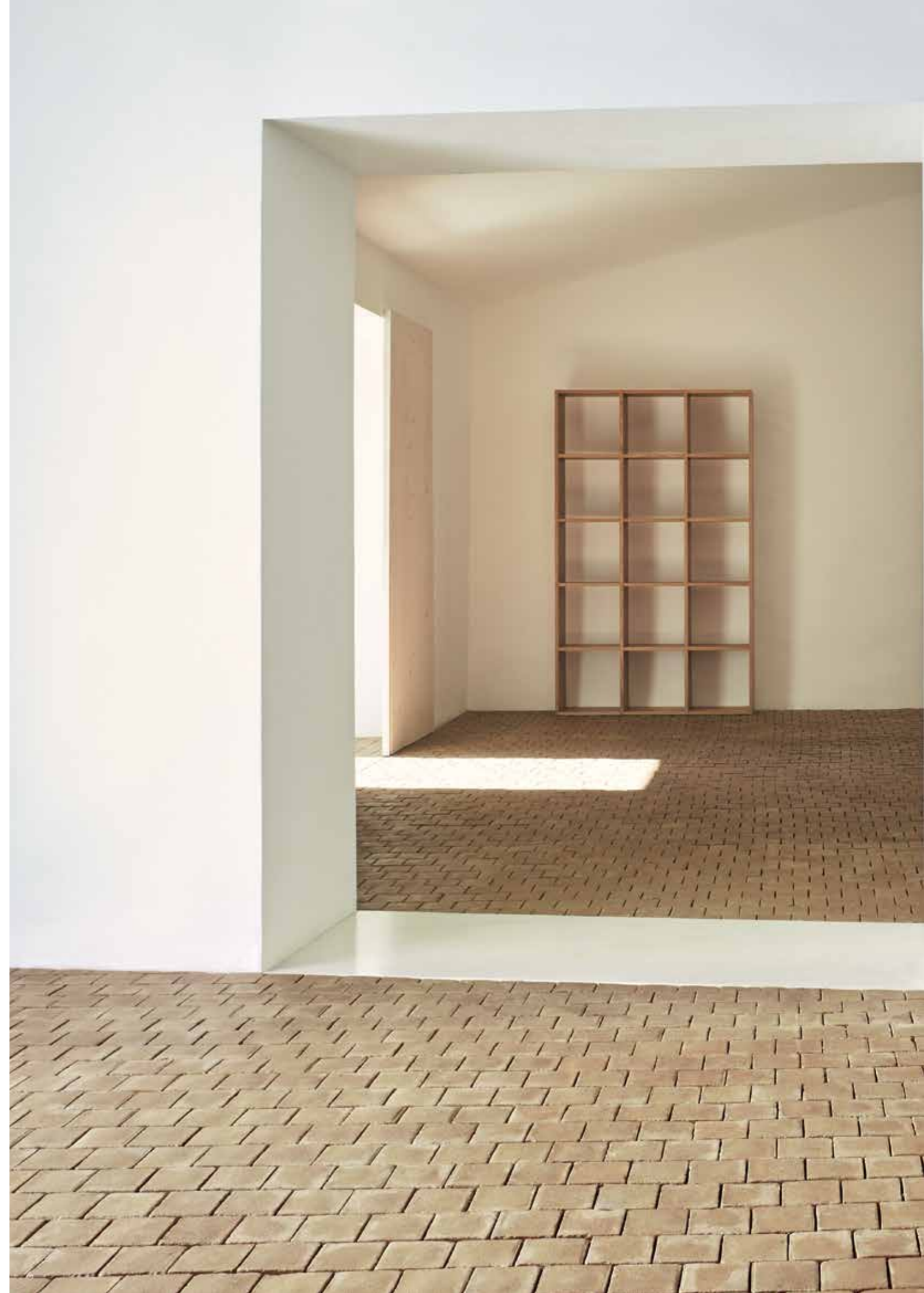

## Pictorial Indicator Used In Catalog



Prefabrication Unit +  
Assembly Time (min)



Can be  
assembled alone



To be assembled by  
two or more persons



Product with optional  
parts sold separately



Requires Phillips  
Screw Driver



## STORAGE & STORAGE UNITS

### The right storage frees up your space for living.

MUJI storage keeps the objects in your life neat and tidy, shaping a pleasant setting for your day-to-day life. Our storage furniture is designed based on the standard dimensions for Japanese homes, yet integrates seamlessly with different styles and cultures. Use these pieces alone or in combination to organise your things and efficiently use the space you have. In a variety of materials to suit different needs, our boxes and baskets are designed to fit our storage furniture and create a

natural, comfortable atmosphere in your home.

Organising your things frees up your space for living just the way that reflects your personality. Arrange and rearrange desks and chairs as needed as a workspace where people gather. Get more pleasure from your living room, using the walls to display your favourite things and personal interests. MUJI storage is ready to help create a simple, pleasant life.

## Storage Furniture

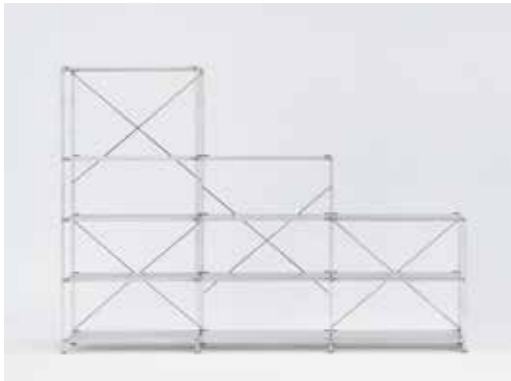

**Stainless Steel / Steel Unit Shelf** ..... 8

Mix and match the wide selection of optional parts to create your ideal unit shelf.



**Stacking Shelf** ..... 20

Extend these shelves out or up. Backless to work as a room divider, as well.



**Oak Storage** ..... 30

Chests and cabinets made of North American white oak and walnut.



**Pulp Board Box** ..... 34

Light and sturdy storage boxes that can be used upright or on their side.



**Stacking Cabinet** ..... 26

Create an AV rack, bookshelves, or living room or bedroom storage to suit your particular needs.

# Stainless Steel Unit Shelf Unit Shelf

Stainless Steel Unit Shelves made with selectable parts to match your style and usage.  
Create your own functional shelf for any purpose, from laundry rack to wardrobe, bookshelf, and desk.



**Basic Set**  
P10



**Shelf Board Frame Cross Bar**  
P11



**Narrow Type Shelf / Height Adjustment Bracket**  
Stainless steel P32  
Steel P39  
\* Only stainless steel for narrow type shelf



**Corner Shelf**  
P12



**Wardrobe Bar**  
Stainless steel P13



**Back Panel**  
P13



### Stainless Steel Unit Shelf Set

The basic combinations are provided as sets in two different sizes. Shelves are available in three types: stainless steel, oak, and walnut.

#### Stainless Steel Shelf Set

61179063	Wide / Large	\$509.00
61179032	Large	\$459.00
61179070	Wide / Medium	\$459.00
61179049	Medium	\$349.00
61179087	Wide / Small	\$339.00
61179056	Small	\$279.00

#### Oak Shelf Set

1 37238992	Wide / Large	\$609.00
37236493	Large	\$509.00
37239005	Wide / Medium	\$509.00
37238978	Medium	\$459.00
37239012	Wide / Small	\$389.00
37238985	Small	\$339.00

#### Walnut Shelf Set

37236462	Wide / Large	\$649.00
37236424	Large	\$529.00
37236479	Wide / Medium	\$529.00
37236431	Medium	\$469.00
37236486	Wide / Small	\$399.00
37236455	Small	\$349.00

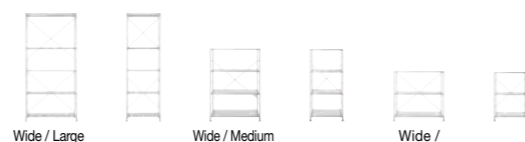

Wide / Large: W 86 x D 41 x H 175.5 cm	
Large: W 58 x D 41 x H 175.5 cm	
Wide / Medium: W 86 x D 41 x H 120 cm	
Medium: W 58 x D 41 x H 120 cm	
Wide / Small: W 86 x D 41 x H 83 cm	
Small: W 58 x D 41 x H 83 cm	

### Shelf Board

There are six different materials and forms available. Choose the one that will suit your room and needs.

#### Additional Stainless Steel Shelf

61179155	For W 84 cm	\$79.00
61179162	For W 56 cm	\$59.00
61179179	For W 42 cm	\$49.00



#### Additional Shelf / Light Grey

37414525	For W 84 cm	\$49.00
37414532	For W 56 cm	\$39.00
37414549	For W 42 cm	\$33.00



#### Additional Shelf / Dark Grey

37414488	For W 84 cm	\$49.00
37414495	For W 56 cm	\$39.00
37414501	For W 42 cm	\$33.00



#### Additional Oak Shelf

37167025	For W 84 cm	\$89.00
37167032	For W 56 cm	\$69.00
37167049	For W 42 cm	\$59.00



This type of shelf board for Unit Shelf uses oak for the sliced veneer.

#### Additional Walnut Shelf

1 37167056	For W 84 cm	\$99.00
37167063	For W 56 cm	\$79.00
37167070	For W 42 cm	\$69.00



This type of shelf board for Unit Shelf uses walnut for the sliced veneer.

[Withstand Load]	[Effective Inside Dimensions]
Each shelf: approx. 30 kg	W 112 cm type: W 108 x D 39.5 cm
H 175.5 cm type: Max. 100 kg	W 84 cm type: W 80 x D 39.5 cm
H 120 cm type: Max. 75 kg	W 56 cm type: W 52 x D 39.5 cm
H 83 cm type: Max. 50 kg	W 42 cm type: W 38 x D 39.5 cm
H 46 cm type: Max. 30 kg	

\* When load is distributed evenly across the entire unit

### Cross Bar

These reinforcement parts are to attach to the shelf and to provide greater stability. They reduce the shakiness and steady the shelf.

#### Stainless Cross Bar

2 61179261	Large / for W 84 cm	\$26.00
61179278	Small / for W 42-56 cm	\$23.00

Cross Bars provide stability between the connected shelf frames.

### Frame

A part that supports the shelf boards. You can make your own original shelf by connecting them horizontally and by choosing the height.

#### Additional Stainless Frame

61179223	Large	\$109.00
3 61179230	Medium	\$89.00
61179247	Small	\$59.00
61179254	Mini	\$49.00

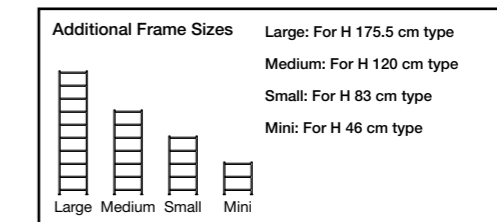

The storage goods on P74 - 89 with this symbol fit nicely on the Unit Shelf.

\*1 The shelf boards are made of steel, and the hooks are made of stainless steel to allow them to be combined with the frames of Stainless Steel Unit Shelves.



**Height Adjustment Bracket**

**76580850** Set of 4 **\$19.00**

- \* Up to three sets of Height Adjustment Brackets (enough for three shelf boards) can be used for each set of shelves.
- \* Shelves with Height Adjustment Brackets attached can be raised up approximately 9.5 cm higher.
- \* Make sure to use this item together with shelves without any bracket.
- \* This item cannot be attached to an Additional Shelf / Wire Type, Additional Shelf / Corner Type or Additional Shelf / Narrow Type.



**Shelf Board / Corner Type**

With this L-shaped shelf board, the space can be used more effectively. By changing the position of the metal fittings, you can change the direction of the connection.

**Additional Shelf / Corner Type (For W 84 cm)**

1 **37413887** Oak **\$149.00**  
**37413894** Walnut **\$159.00**

- \* If you use an Additional Shelf / Corner Type without attaching it to another shelf, Reinforcement Parts (\* 1) and Cross Bars (\* 2) are necessary to strengthen the unit. Depending on the combination, the number or type of pieces required may vary.

[Withstand Load]	[Effective Inside Dimensions]
Shelf board: approx. 30 kg * When load is distributed evenly across the entire unit	

**Corner Type Combination Patterns**

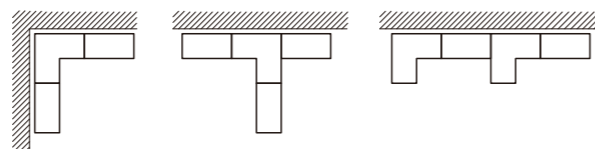

You can combine the shelves to match your room's layout.  
 \* Please see P39 for the number of shelf boards required.

**Wardrobe Bar**

A part that turns your Unit Shelf into a wardrobe.

**Steel Unit Shelf / Wardrobe Bar**

1 **61179797** For W 84 cm type **\$33.00**  
**61179803** For W 56 cm type **\$29.00**  
 Withstand load: 10 kg

**Back Panel**

A part to reduce swaying and be used as a partition. Magnets can be attached to light grey and dark grey types.

**Back Panel / S / Light Grey (2 Compartment Type)**

**76580959** For W 84 cm **\$26.00**  
**76580966** For W 56 cm **\$23.00**



**Back Panel / L / Light Grey (3 Compartment Type)**

2 **76580973** For W 84 cm **\$39.00**  
**76580980** For W 56 cm **\$33.00**

**Back Panel / S / Dark Grey (2 Compartment Type)**

**76580997** For W 84 cm **\$26.00**  
**76581000** For W 56 cm **\$23.00**



**Back Panel / L / Dark Grey (3 Compartment Type)**

**76580775** For W 84 cm **\$39.00**  
**76580782** For W 56 cm **\$33.00**



\* Usage example

**Side Panel**

A part that turns a Unit Shelf into a bookshelf.

**Side Panel / S / 2 Compartment Type**

**76580898** Light grey  
**76580904** Dark grey **Each \$23.00**



**Side Panel / L / 3 Compartment Type**

**76581390** Light grey  
**76581406** Dark grey **Each \$33.00**



**Side Inner Panel / S / 2 Compartment Type**

**37414662** Light grey  
**37414679** Dark grey **Each \$27.90**



**Side Inner Panel / L / 3 Compartment Type**

**37414686** Light grey  
**37414693** Dark grey **Each \$36.00**



This panel is to attach to the inside of the Unit Shelf.

- \* The Side Panels and Side Inner Panels are specifically for D 41 cm type. It cannot be used with D 25 cm type.



**Casters**

Casters to make the shelf movable.

**Caster / Grey**

1 **61179780** Set of 4 **\$19.00**

- \* Do not use the casters with L-sized frames.
- \* Changing the adjusters to casters increases the total height by 5.1 cm.
- \* When using casters, consider the withstand load to be half of the withstand load of when used without casters.

**Auxiliary Parts**

Attach the Reinforcement Part instead of the bottom shelf, and use the space for large items such as a washing machine or refrigerator.

**Reinforcement Part For Frame / D 41 cm Type**

2 **76580874** For W 84 cm type **\$43.00**

Inside dimensions: W 78 x D 36 cm

**76580881** For W 56 cm type **\$39.00**

Inside dimensions: W 50 x D 36 cm

\* It cannot be used for D 25 cm type.





# Steel Unit Shelf

Available in a variety of heights and depths, this Steel Unit Shelf can be customised to meet your storage requirements. The base material is steel, and the grey colour is suitable for any kind of space.

## Steel Unit Shelf Set

Basic sets in two widths and four heights.

### Steel Shelf Set / Grey

	61179391	Wide / Large	\$279.00
	61179353	Large	\$219.00
1	61179407	Wide / Medium	\$209.00
	61179360	Medium	\$169.00
	61179414	Wide / Small	\$159.00
	61179377	Small	\$139.00
	61179421	Wide / Mini	\$129.00
2	61179384	Mini	\$109.00



Wide / Large: W 86 x D 41 x H 175.5 cm	25 ii
Large: W 58 x D 41 x H 175.5 cm	25 ii
Wide / Medium: W 86 x D 41 x H 120 cm	25 ii
Medium: W 58 x D 41 x H 120 cm	25 ii
Wide / Small: W 86 x D 41 x H 83 cm	15 ii
Small: W 58 x D 41 x H 83 cm	15 ii
Wide / Mini: W 86 x D 41 x H 46 cm	15 ii
Mini: W 58 x D 41 x H 46 cm	15 ii



## Shelf Board / Depth 41 cm

Two types of material are available. Please choose the type according to the space or what you store.

### Additional Steel Shelf / Grey

61179551	For W 84 cm	\$33.00
61179568	For W 56 cm	\$29.00
61179575	For W 42 cm	\$23.00



### Additional Wooden Shelf / Grey

1	61179582	For W 84 cm	\$49.00
	61179599	For W 56 cm	\$39.00
	61179605	For W 42 cm	\$33.00



[Withstand load of D 41 cm type] Each shelf: approx. 30 kg H 175.5 cm type: Max. 100 kg H 120 cm type: Max. 75 kg H 83 cm type: Max. 50 kg H 46 cm type: Max. 30 kg	[Inside dimensions of D 41 cm type Shelf Board] W 84 cm type: W 80 x D 39.5 cm W 56 cm type: W 52 x D 39.5 cm W 42 cm type: W 38 x D 39.5 cm
--	---

\* When load is distributed evenly across the entire unit

## Frame / Depth 41 cm

Parts that support the shelf boards. You can make your own original shelf by connecting them horizontally and by choosing the height.

### Additional Steel Frame / Grey

2	61179629	Large	\$49.00
	61179636	Medium	\$39.00
	61179643	Small	\$29.00
	61179650	Mini	\$19.00

Additional Frame Sizes	Large: For H 175.5 cm type
	Medium: For H 120 cm type
	Small: For H 83 cm type
	Mini: For H 46 cm type

## Auxiliary Parts

This part can be attached instead of a shelf board, creating a space in the bottom of the shelf unit.



### Reinforcement Part For Frame / Grey

61179766	For W 84 cm type	\$29.00
Inside dimensions: W 78 x D 36 cm		
61179773	For W 56 cm type	\$23.00
Inside dimensions: W 50 x D 36 cm		

\* It cannot be used with D 25 cm type.

## Cross Bar

These reinforcement parts provide greater stability. They reduce shakiness and steady the shelf.

### Cross Bar / Grey

3	61179667	Large / For W 84 cm	\$10.90
	61179674	Small / For W 42-56 cm	\$9.90

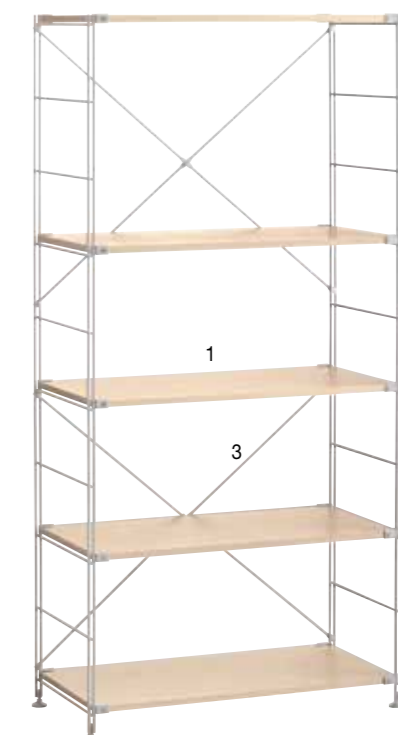

## Height Adjustment Bracket

Enable shelf height adjustment by replacing the standard shelf brackets with these parts.

### Height Adjustment Bracket





76580867	Set of 4	\$13.90
----------	----------	---------

\* Up to three sets of Height Adjustment Brackets (enough for three shelf boards) can be used for each set of shelves.  
\* Shelves with Height Adjustment Brackets attached can be raised up approximately 9.5 cm higher.  
\* Make sure to use this item together with shelves without any bracket.

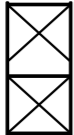

## Reference Table for Required Number of Unit Shelf Parts

To ensure a certain level of stability for Unit Shelves, a specified number of parts are required for assembly. Refer to the table below for the minimum number of parts required for your particular configuration.

Frame size		 Large	 Medium	 Small	 Mini
W 84 cm	Shelf Boards or Reinforcement Parts For	3	3	2	3
	Cross Bar / Large	2	1	1	0
W 56 cm	Shelf Boards or Reinforcement Parts For	3	3	2	3
	Cross Bar / Small	2	1	1	0
W 42 cm	Shelf Board	3	3	2	3
	Cross Bar / Small	2	1	1	0

\* The stability may also vary depending on the location of the assembled parts. The stability of the unit may decrease if the shelf boards are not evenly spaced, even if more than the required number of parts are used. In particular, if you do not use a shelf board at the top or bottom of the unit, or if you leave an excess space between the shelves, it may cause the unit to be unstable. Make sure to install the shelf boards evenly spaced.

\* Side Panels, and the Additional Shelf / Narrow Type are not designed to function effectively as reinforcement part for frame.  
\* The required number of parts may vary depending on the configuration when Cross Bars are used to replace the Back Panel.

### Notes on using Unit Shelf Parts

Unit Shelves cannot be assembled in the configurations shown in the illustrations below.

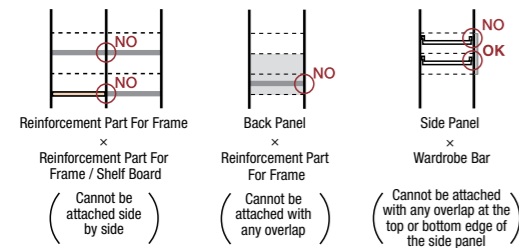

\*1 This item cannot be attached to an Additional Stainless Steel Shelf / Wire Type or Additional Shelf / Narrow Type.

## Our Approach to Standard Dimensions of Modules

The standard dimensions of modules are based on "shaku", which is a unit of measurement used in the construction of Japanese homes. These dimensions are used in a wide variety of items ranging from large furniture to small storage items. For example, the height of a unit shelf is based on the height of a "kamoi" (lintel) or door, and shelf width is based on the width of a half "ken" (91 cm), so that they can fit neatly within the width of 1 "ken" (182 cm), between two columns.

### Unit shelf module dimensions "175 cm and 86 cm"

The 175 cm height corresponds the height of doors in Japanese homes. The 86 cm width is based on the "ken" (182 cm), which is a unit of measurement used in the construction of Japanese homes. "Outer width 86 cm, inner width 84 cm" which is slightly less than a half "ken" (91 cm), is a standard dimension for MUJI products.

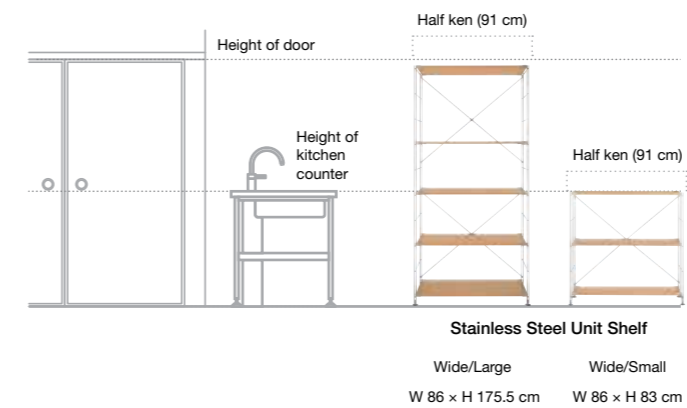

### Storage item module dimensions "37 cm and 26 cm"

Storage item modules are sized to fit neatly in storage furniture with dimensions of 175 cm and 86 cm. The module dimensions of 26 cm and 37 cm, which are designed to fit on shelves, are based on the inside dimensions of shelves (W 80 × H 35 cm). See P82 for more details.

 Size that fits on unit shelf: W 26 × D 37 cm

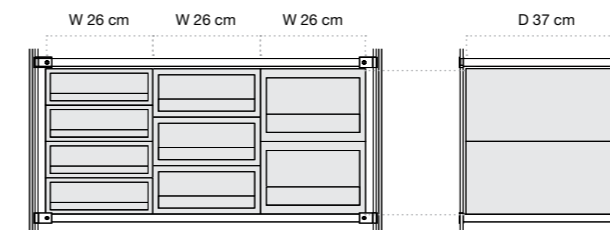

Polypropylene Storage Case

Thin Shallow Deep

Deep

 Size that fits on stackable shelf: W 37 × D 26 cm

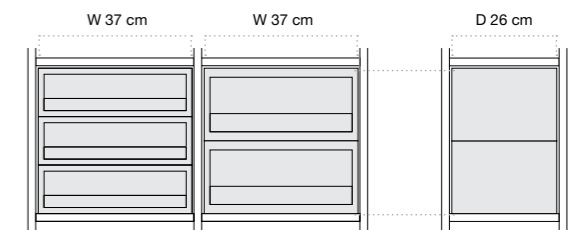

Polypropylene Storage Case / Wide

Shallow Deep

Deep

# Stacking Shelf

A shelf which can be extended both vertically and horizontally to suit various needs. As this shelf does not have a rear panel, it can be used as a bookshelf, a decorative shelf, or even as a room dividing shelf. A wide type is also available to suit different applications.



Stacking Shelf / Basic Set / 5 Shelves  
 1 **38932116** Oak **\$309.00**  
**38932314** Walnut **\$339.00**  
 W 42 x D 28.5 x H 200 cm

Stacking Shelf / Additional Set / 5 Shelves  
 2 **37263208** Oak **\$279.00**  
**37265677** Walnut **\$309.00**  
 W 40 x D 28.5 x H 200 cm  
 Inside dimensions of each shelf:  
 W 37.5 x D 28.5 x H 37.5 cm  
 Withstand load: 20 kg per shelf, 60 kg total

Stacking Shelf / Wide Type / Basic Set / 5 Shelves  
**38932178** Oak **\$399.00**  
**38932376** Walnut **\$439.00**  
 W 81.5 x D 28.5 x H 200 cm

Stacking Shelf / Wide Type / Additional Set / 5 Shelves  
**37263260** Oak **\$369.00**  
**37265738** Walnut **\$399.00**  
 W 79.5 x D 28.5 x H 200 cm  
 Inside dimensions of each shelf:  
 W 77 x D 28.5 x H 37.5 cm  
 Withstand load: 20 kg per shelf, 60 kg total

Stacking Shelf / Basic Set / 3 Shelves  
**38932109** Oak **\$239.00**  
 3 **38932307** Walnut **\$279.00**  
 W 42 x D 28.5 x H 121 cm

Stacking Shelf / Additional Set / 3 Shelves  
**37263192** Oak **\$229.00**  
**37265660** Walnut **\$259.00**  
 W 40 x D 28.5 x H 121 cm  
 Inside dimensions of each shelf:  
 W 37.5 x D 28.5 x H 37.5 cm  
 Withstand load: 20 kg per shelf, 40 kg total

Stacking Shelf / Wide Type / Basic Set / 3 Shelves  
**38938161** Oak **\$329.00**  
**38932369** Walnut **\$359.00**  
 W 81.5 x D 28.5 x H 121 cm

Stacking Shelf / Wide Type / Additional Set / 3 Shelves  
**37263253** Oak **\$309.00**  
 4 **37265721** Walnut **\$399.00**  
 W 79.5 x D 28.5 x H 121 cm  
 Inside dimensions of each shelf:  
 W 77 x D 28.5 x H 37.5 cm  
 Withstand load: 20 kg per shelf, 40 kg total

Stacking Shelf / Basic Set / 2 Shelves  
**38932093** Oak **\$199.00**  
**38932291** Walnut **\$229.00**  
 W 42 x D 28.5 x H 81.5 cm

Stacking Shelf / Additional Set / 2 Shelves  
**37263185** Oak **\$179.00**  
**37265653** Walnut **\$209.00**  
 W 40 x D 28.5 x H 81.5 cm  
 Inside dimensions of each shelf:  
 W 37.5 x D 28.5 x H 37.5 cm  
 Withstand load: 20 kg per shelf, 30 kg total

Stacking Shelf / Wide Type / Basic Set / 2 Shelves  
 5 **38932154** Oak **\$279.00**  
**38932352** Walnut **\$309.00**  
 W 81.5 x D 28.5 x H 81.5 cm

Stacking Shelf / Wide Type / Additional Set / 2 Shelves  
**37263246** Oak **\$259.00**  
**37265714** Walnut **\$289.00**  
 W 79.5 x D 28.5 x H 81.5 cm  
 Inside dimensions of each shelf:  
 W 77 x D 28.5 x H 37.5 cm  
 Withstand load: 20 kg per shelf, 30 kg total

## Extending shelves vertically or horizontally

By combining a basic set with additional sets, you can extend the shelves vertically and horizontally to achieve your desired configuration. MUJI's storage items fit nicely in these shelves.



\* The characteristics of natural wood, such as the colour and grain pattern, may vary in appearance depending on the material.  
 \* Assembly needs to be performed in an area with enough space to lay the shelf unit on its side. \* Withstand loads are calculated based on evenly distributed weight.

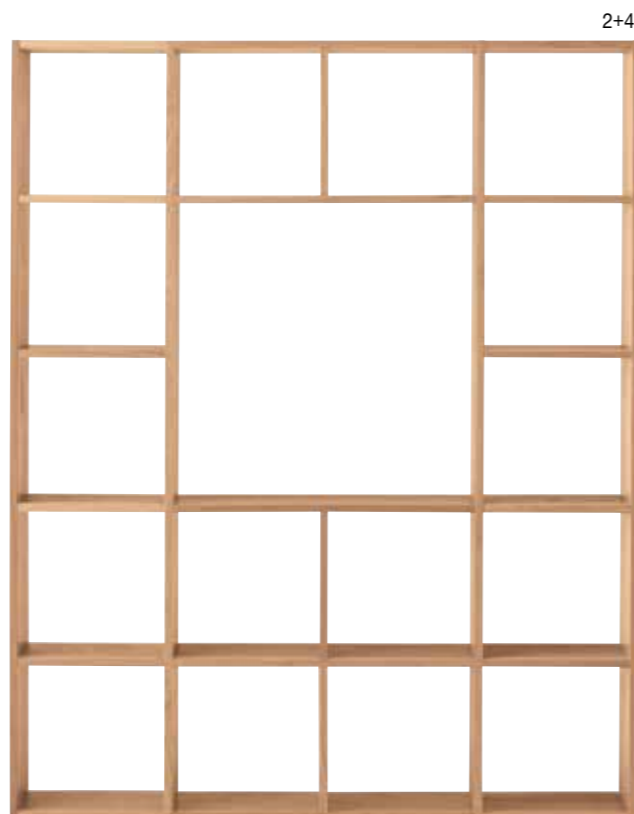

\* Usage example

**Stacking Shelf / Open Type Additional Set**

This item is designed for use with the Stacking Shelf / Open Type. Use it in combination with a Stacking Shelf / 5 Shelves.

Stacking Shelf / Open Type / Additional Set / 5 Shelves / 3 Compartments	
1 <b>38932215</b> Oak	\$499.00
1 <b>38932413</b> Walnut	\$569.00
W 120 x D 28.5 x H 200 cm	
Inside dimensions of each shelf: W 37.5 x D 28.5 x H 37.5 cm	
Open space: W 116.5 x D 28.5 x H 116.5 cm	
Withstand load Top storage section: 20 kg total, Middle top board: 40 kg	

Stacking Shelf / Open Type / Additional Shelf / 5 Shelves / 3 Compartments	
3 <b>37263284</b> Oak	\$199.00
3 <b>37265752</b> Walnut	\$229.00
W 118 x D 28.5 x H 40 cm	
Inside dimensions of each shelf: W 37.5 x D 28.5 x H 37.5 cm	
Withstand load Top board: 40 kg	

Stacking Shelf / Open Type / Additional Set / 5 Shelves / 2 Compartments	
2 <b>38932239</b> Oak	\$399.00
2 <b>38932437</b> Walnut	\$479.00
W 80 x D 28.5 x H 200 cm	
Inside dimensions of each shelf: W 37.5 x D 28.5 x H 37.5 cm	
Open space: W 77 x D 28.5 x H 116.5 cm	
Withstand load Top storage section: 20 kg total, Middle top board: 30 kg	

Stacking Shelf / Open Type / Additional Shelf / 5 Shelves / 2 Compartments	
4 <b>37263307</b> Oak	\$129.00
4 <b>37267046</b> Walnut	\$159.00
W 78 x D 28.5 x H 40 cm	
Inside dimensions of each shelf: W 37.5 x D 28.5 x H 37.5 cm	
Withstand load Top board: 30 kg	

\* This item cannot be used while laid on its side. \*1

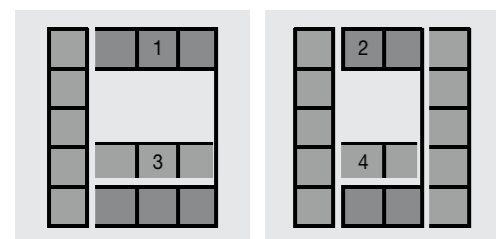

Example combination for stacking shelf / open type  
\* See P51 for structural details.

\*1 Use this item in combination with a Stacking Shelf / Basic Set / 5 Shelves. It cannot be used in combination with a Stacking Shelf / Wide Type / Basic Set / 5 Shelves.  
\* The characteristics of natural wood, such as the colour and grain pattern, may vary in appearance depending on the material.  
\* Assembly needs to be performed in an area with enough space to lay the shelf unit on its side. \* Withstand loads are calculated based on evenly distributed weight.



\* Usage example

**Stacking Shelf Set**

Stacking Shelf / 5 Shelves / 3 Compartments	
1 <b>38932259</b> Oak	\$729.00
1 <b>38932451</b> Walnut	\$799.00
W 122 x D 28.5 x H 200 cm	
Inside dimensions of each compartment: W 37.5 x D 28.5 x H 37.5 cm	
Withstand load: 20 kg per shelf, 90 kg total	



Stacking Shelf / 5 Shelves / 2 Compartments	
1 <b>38932260</b> Oak	\$519.00
1 <b>38932468</b> Walnut	\$569.00
W 82 x D 28.5 x H 200 cm	
Inside dimensions of each compartment: W 37.5 x D 28.5 x H 37.5 cm	
Withstand load: 20 kg per shelf, 60 kg total	



\* Usage example

Stacking Shelf / 3 Shelves / 3 Compartments	
1 <b>38932277</b> Oak	\$609.00
2 <b>38932475</b> Walnut	\$699.00
W 122 x D 28.5 x H 121 cm	
Inside dimensions of each compartment: W 37.5 x D 28.5 x H 37.5 cm	
Withstand load: 20 kg per shelf, 60 kg total	



Stacking Shelf / 3 Shelves / 2 Compartments	
1 <b>38932284</b> Oak	\$399.00
2 <b>38932482</b> Walnut	\$469.00
W 82 x D 28.5 x H 121 cm	
Inside dimensions of each compartment: W 37.5 x D 28.5 x H 37.5 cm	
Withstand load: 20 kg per shelf, 40 kg total	



\* The characteristics of natural wood, such as the colour and grain pattern, may vary in appearance depending on the material.  
\* Assembly needs to be performed in an area with enough space to lay the shelf unit on its side. \* Withstand loads are calculated based on evenly distributed weight.



**Optional Parts for Stacking Shelf**

**Stacking Chest / 2 Drawers**

	37414723	Oak	\$109.00
1	37414754	Walnut	\$129.00

W 37 × D 28 × H 37 cm  
Withstand load: Top board 5 kg, each drawer 3 kg, total 5 kg  
Inside dimensions of drawer: W 33.5 × D 24.5 × H 15.5 cm

**Stacking Chest / 4 Drawers**

	37414747	Oak	\$129.00
2	37414778	Walnut	\$149.00

W 37 × D 28 × H 37 cm  
Withstand load: Top board 5 kg, each drawer 2 kg, total 5 kg  
Inside dimensions of drawer: W 33.5 × D 24.5 × H 6 cm

**Stacking Chest / 4 Drawers**

	37414730	Oak	\$129.00
3	37414761	Walnut	\$149.00

W 37 × D 28 × H 37 cm  
Withstand load: Top board 5 kg, each drawer 2 kg, total 5 kg  
Inside dimensions of drawer: W 15 × D 24.5 × H 15.5 cm

The Stacking Chests are sized to fit perfectly in the spaces of the Stacking Shelf.  
(Anti-slip pads are included.)

When stacking chests vertically, attach the Metal Joint Fittings For Pulp Board Boxes 18960941 (set of 2) (P61) to the back of the chests.

\* The characteristics of natural wood, such as the colour and grain pattern, may vary in appearance depending on the material.  
\* Withstand loads are calculated based on evenly distributed weight.  
\* The material used inside the drawers (MDF) may have a distinct smell. Although the smell will fade with use, it is recommended to avoid storing clothing or other items that can absorb odour inside the drawers.

**Structure of the Stacking Shelves**

Original storage furniture can be freely created by combining a basic set with additional sets. As shown below, the units can be easily linked by connecting the steel pipes within the dividers and fasten them with bolts.

**Stacking mechanism**

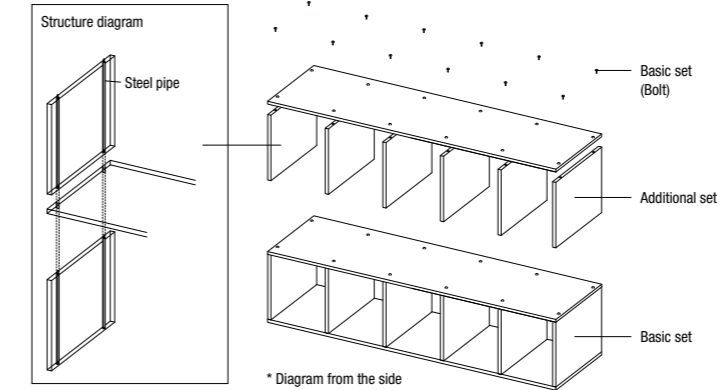

**Example of combination and withstand load**

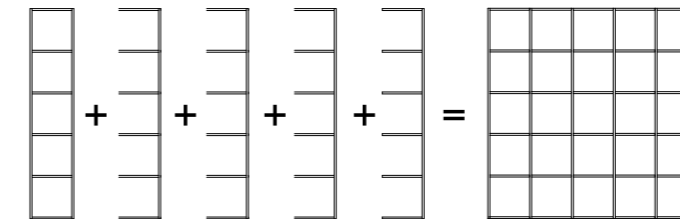

Basic Set / 5 Shelves × 1 + Additional Set / 5 Shelves × 4

A combination method consisting of a shelf in the upright direction and additional units linked to the side.

Withstand load: 150 kg total = 60 kg × 5 units ÷ 2

$$\text{Total withstand load when shelves are combined} = \text{Withstand load of set} \times \text{number of units} \div 2$$

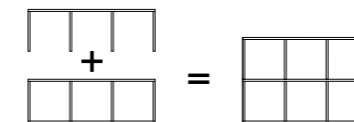

Basic Set / 3 Shelves × 1 + Additional Set / 3 Shelves × 1

A combination method consisting of a shelf placed sideways and additional units linked on top.

Withstand load: 40 kg total = 40 kg × 2 units ÷ 2

$$\text{Total withstand load when shelves are combined} = \text{Withstand load of set} \times \text{number of units} \div 2$$

**Example of Usage**

**Combination of differing tiers**

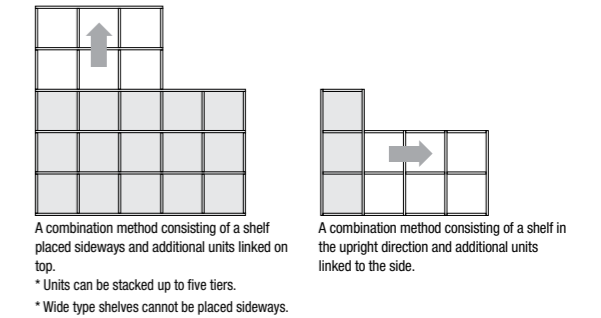

A combination method consisting of a shelf placed sideways and additional units linked on top.  
\* Units can be stacked up to five tiers.  
\* Wide type shelves cannot be placed sideways.

**Combination of items with differing widths**

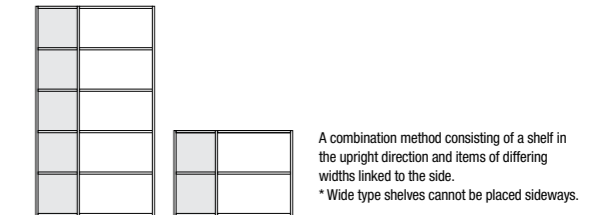

A combination method consisting of a shelf in the upright direction and items of differing widths linked to the side.  
\* Wide type shelves cannot be placed sideways.

**Using as a partition**

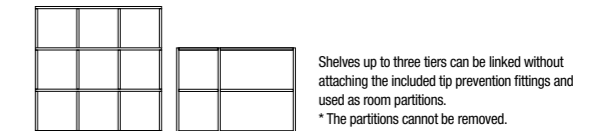

Shelves up to three tiers can be linked without attaching the included tip prevention fittings and used as room partitions.  
\* The partitions cannot be removed.

**Structure of the Stacking Shelf / Open Type**

Storage furniture can be freely created by using steel pipes to combine the basic set with open type components. The two following patterns are basic combinations. (Common to 2 Compartment and 3 Compartment models.)

**Combination pattern 1**

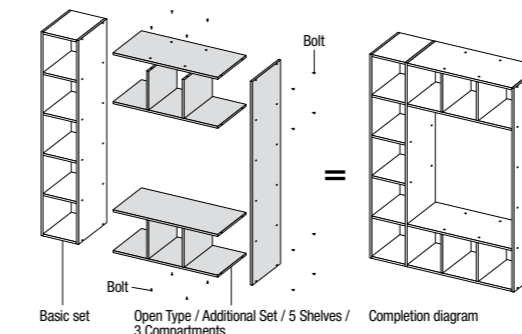

**Combination pattern 2**

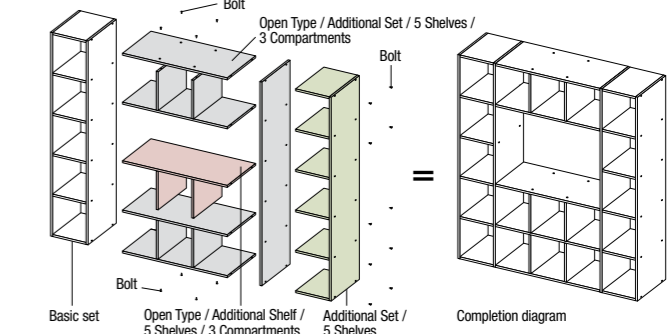

# Stacking Cabinet

Cabinets that make it possible to create original storage by combining a standard set with additional components.

Whether it is to make an AV rack, a bookshelf, or storage furniture for the living room or bedroom, storage units to suit each need can be created simply by combining components of your choice.



## Combining various parts to create a storage unit that suits your specific needs

By combining a standard set with additional sets and optional parts, you can create a cabinet such as a wall storage unit, AV rack, chest, or cupboard that is easy to use and well-suited to your space.



**Stacking Cabinet / Standard Set / 162.5 cm**  
 1 **38918073** Oak **\$479.00**  
 W 162.5 x D 39.5 x H 45 cm  
 Withstand load: 65 kg for top board, 5 kg per compartment (for both 78 cm-wide and 37.5 cm-wide)

**Stacking Cabinet / Additional Set / 162.5 cm**  
**38917908** Oak **\$429.00**  
 W 162.5 x D 39.5 x H 40 cm  
 Inside dimensions of each compartment (with shelf board in centre, no doors): W 78 x D 38 x H 17.5 cm



**Stacking Cabinet / Standard Set / 82.5 cm**  
**38918080** Oak **\$289.00**  
 W 82.5 x D 39.5 x H 45 cm  
 Withstand load: 40 kg for top board, 5 kg per compartment

**Stacking Cabinet / Additional Set / 82.5 cm**  
**38917915** Oak **\$249.00**  
 W 82.5 x D 39.5 x H 40 cm  
 Inside dimensions of each compartment (with shelf board in centre, no doors): W 78 x D 38 x H 17.5 cm



- \* The shelf can be adjusted to three heights in 6 cm intervals.
- \* The rear panel has a wiring hole and a space at the rear of the shelf to enable access when wiring an electric equipment from both the top and bottom of the cabinet.
- \* The effective inside dimension of the hole for cables is 2.5 cm.



**Stacking Cabinet High Add On**  
 2 **38917939** Oak **\$569.00**  
 W 162.5 x D 39.5 x H 79.5 cm  
 Tolerable weight: Top board 30kg  
 The high type (additional set) can only be installed on the second stack and 1 stack of the additional set can be added onto it (width 162.5cm type only)

\* The characteristics of natural wood, such as the colour and grain pattern, may vary in appearance depending on the material.  
 \* Withstand loads are calculated based on evenly distributed weight.  
 \* Assembly needs to be performed in an area with enough space to lay the cabinet unit on its side. Take note of this especially when combining the high-type cabinet.



\* Usage example

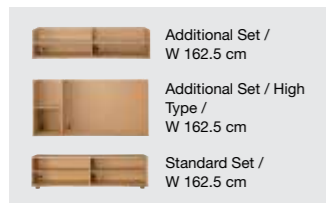

Combination example of Stacking Cabinet

### Additional components

#### Stacking Cabinet / Dividing Board

1 **[38917892]** Oak **\$39.00**

T 2.5 x D 37.5 x H 37.5 cm

This component cannot be used together with the wooden / glass doors.

#### Stacking Cabinet / Drawer / Large

2 **[38917885]** Oak **\$79.00**

W 77.5 x D 37.5 x H 17.5 cm

Inside dimensions of drawer: W 75 x D 32.5 x H 15.5 cm

Withstand load: 5 kg

\* The Drawer can be installed to units that are up to 125 cm tall.

#### Stacking Cabinet / Glass Door / Pair

3 **[38917861]** **\$59.00**

\* Attachable to both the oak and walnut models.

\* When additionally attaching the doors after the unit has been assembled, it will be necessary to once remove the board used on the bottom of the unit.

\* The inside dimensions of the unit will become approximately 37 cm when the glass doors are attached.

\* The Glass Doors are to be used for only the bottommost tier. They cannot be used at the height of the top or second tier in a stacked combination.

#### Stacking Cabinet / Wooden Door / Pair

4 **[38917878]** Oak **\$79.00**

\* When additionally attaching the Wooden Doors after the unit has been assembled, it will be necessary to once remove the board used on the bottom of the unit.

\* The inside dimensions of the unit will become approximately 36 cm when the Wooden Doors are attached.



Dividing Board Drawer / Large Glass Door Wooden Door

Separately sold components can be added to accommodate changes in your lifestyle.



\* The TV is not included as part of the product.  
\* Example of a combination with a 40-inch television

Base	<b>\$479.00</b>
Glass door	<b>\$59.00</b>
Drawer x2	<b>\$79.00</b>
TOTAL	<b>\$696.00</b>



\* The TV is not included as part of the product.  
\* Example of a combination with a 32-inch television

Base	<b>\$479.00</b>
Wooden door x2	<b>\$158.00</b>
TOTAL	<b>\$637.00</b>



\* The TV is not included as part of the product.  
\* Example of a combination with a 40-inch television

Base	<b>\$479.00</b>
High add-on	<b>\$569.00</b>
Wooden door	<b>\$79.00</b>
Glass door	<b>\$59.00</b>
TOTAL	<b>\$1186.00</b>

## Structure of the Stacking Cabinets

Units can be stacked to form a cabinet of your preference while optional parts can be combined for added convenience.

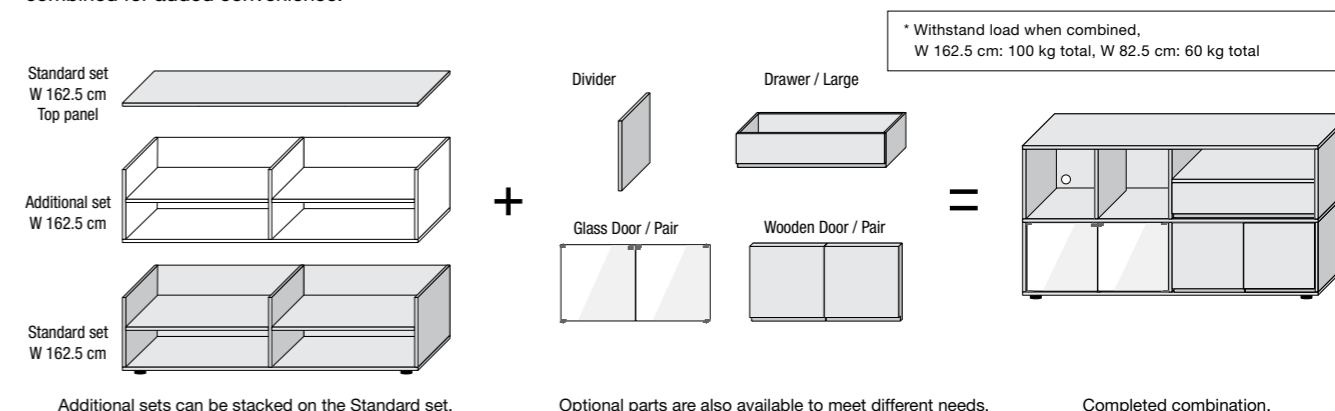

Additional sets can be stacked on the Standard set.  
\* Attach the additional set by removing the top panel.

Optional parts are also available to meet different needs.

Completed combination.

\* Units can be stacked up to five tiers. The cabinet can be used with its legs removed.  
\* One of the rear panels can be removed from a combination of up to three tiers. Please be sure to place an adjustable shelf in the compartment from which the rear panel is removed. Note that glass / wooden doors cannot be attached to the compartment from which the rear panel has been removed. The rear panel cannot be removed in sections where the high-type cabinet is being used. (This arrangement can be useful when placing a large audio visual amplifier or any other equipment that will generate a great amount of heat.)

\* When combining a Stacking Cabinet Set / High Type / W 82.5 cm, the cabinet cannot be used with a height exceeding 165 cm.  
\* Attach a shelf board with two or more tiers or wooden door of high type when using the Stacking Cabinet / High Type / W 82.5 cm.  
\* The Stacking Cabinet / High Type / Additional Set / W 162.5 cm can only be installed on the second tier. One more additional set can be added on top.  
\* Refrain from placing a television wider than the top board on the cabinet.  
\* Drawers can be installed to a height up to 125 cm (i.e. height of six drawers).

# Oak Storage

Wooden storage units made from North American white oak and walnut. As the depth is the same for each model in the series, units can be combined to your preference.

Storage & Storage Units



**1** **15877843** Oak **\$799.00**  
 W 120 x D 40 x H 83 cm  
 Withstand load: 30 kg for top board, 10 kg for adjustable shelf  
 Adjustable shelf: Left (Large) W 75 x D 36 cm Right (Small) W 37 x D 36 cm  
 two large and two small shelves included \*1 \*2

**2** **15877829** Oak **\$579.00**  
 W 80 x D 40 x H 83 cm  
 Withstand load: 30 kg for top board, 10 kg for adjustable shelf  
 Adjustable shelf: W 75 x D 36 cm, two shelves included \*1 \*2



**3** **15877812** Oak **\$579.00**  
 W 80 x D 40 x H 83 cm  
 Adjustable shelf: W 75 x D 36 cm, three shelves included \*1



**4** **15874842** Oak **\$799.00**  
 W 120 x D 40 x H 83 cm  
 Inside dimensions of drawer: W 50 x D 32 x H 11.5 cm  
 Withstand load: 30 kg for top board, 5 kg for each drawer



**5** **15874859** Oak **\$469.00**  
 W 80 x D 40 x H 83 cm  
 Inside dimensions of drawer: (Large) W 70 x D 32 x H 11.5 cm  
 (Small) W 30 x D 32 x H 11.5 cm  
 Withstand load: 30 kg for top board, 5 kg for each drawer \*2

**6** **15874866** Oak **\$799.00**  
 W 80 x D 40 x H 119.5 cm  
 Inside dimensions of drawer: (Large) W 70 x D 32 x H 11.5 cm  
 (Small) W 30 x D 32 x H 11.5 cm  
 Withstand load: 30 kg for top board, 5 kg for each drawer \*2  
 Six drawers provide plenty of storage space.



The heights of the 4-tier chest and cabinets have been made uniform at a height of 83 cm and now easier to use alongside each other. Combine different units to your liking.



\* Due to the use of natural wood, the colour of each product may slightly vary. The colour may also appear differently under different lighting.  
 \* Withstand loads are calculated based on evenly distributed weight.  
 \* The characteristics of natural wood, such as the colour and grain pattern, may vary in appearance depending on the material.

Storage & Storage Units





## AV Rack / 150 cm

1 **15874828** Oak  
 W 150 x D 40 x H 46.5 cm  
 Effective inside dimensions of drawer:  
 (Top) W 65.5 x D 33 x H 14.5 cm  
 (Bottom) W 65.5 x D 33 x H 13.5 cm  
 Inside dimensions of each shelf compartment  
 (when adjustable shelf is placed at the centre):  
 W 72.5 x D 36 x H 16.5 / 14 cm  
 Withstand load: 65 kg for top surface, 5 kg for adjustable shelf,  
 5 kg for drawer  
 Adjustable shelf: W 72.5 x D 31.5 cm, one shelf included  
 \*2

\$739.00



Example of a combination with a 58-inch television



## AV Rack / 110 cm

2 **15874811** Oak  
 W 110 x D 40 x H 46.5 cm  
 Effective inside dimensions of drawer:  
 (Top) W 45.5 x D 33 x H 14.5 cm  
 (Bottom) W 45.5 x D 33 x H 13.5 cm  
 Inside dimensions of each shelf compartment  
 (when adjustable shelf is placed at the centre):  
 W 52.5 x D 36 x H 16.5 / 14 cm  
 Withstand load: 40 kg for top surface, 5 kg for adjustable shelf,  
 5 kg for drawer  
 Adjustable shelf: W 52.5 x D 31.5 cm, one shelf included  
 \*1 \*2

\$549.00



Example of a combination with a 42-inch television



## Dresser With Stool

4 **15874972** Oak  
 W 46 x D 36.5 x H 72 cm Mirror: W 37 x H 25.5 cm  
 Inside dimensions of storage unit: W 37 x D 29 x H 17 cm  
 Withstand load: 15 kg for top board 10 kg for storage unit  
 The polypropylene makeup boxes will fit perfectly inside the dresser.

\$469.00



\* Please be careful not to trap your fingers between the lid and the main unit when opening / closing the lid.



## AV Rack / Flat Type / Sliding Door

**38318347** Width 150 cm \$549.00  
 W 150 x D 35 x H 36.5 cm  
**37153653** Width 110 cm \$469.00  
 W 110 x D 35 x H 36.5 cm

An AV Rack with a relatively small height and depth. This rack has sliding doors in the rear for easy wiring.

\* While the W 150 cm type can be used without supplementary legs, please be sure to attach them when placing objects that weigh more than 20 kg on the top surface.

\* The supplementary leg is not included with the W 110 cm type.



# Pulp Board Box

Light and sturdy storage boxes which can be used upright or on its side. Up to five of these units can be stacked on its side to form a wall storage system.

From A4-sized units to slim-sized models, a variety of shapes and sizes are available to choose from.

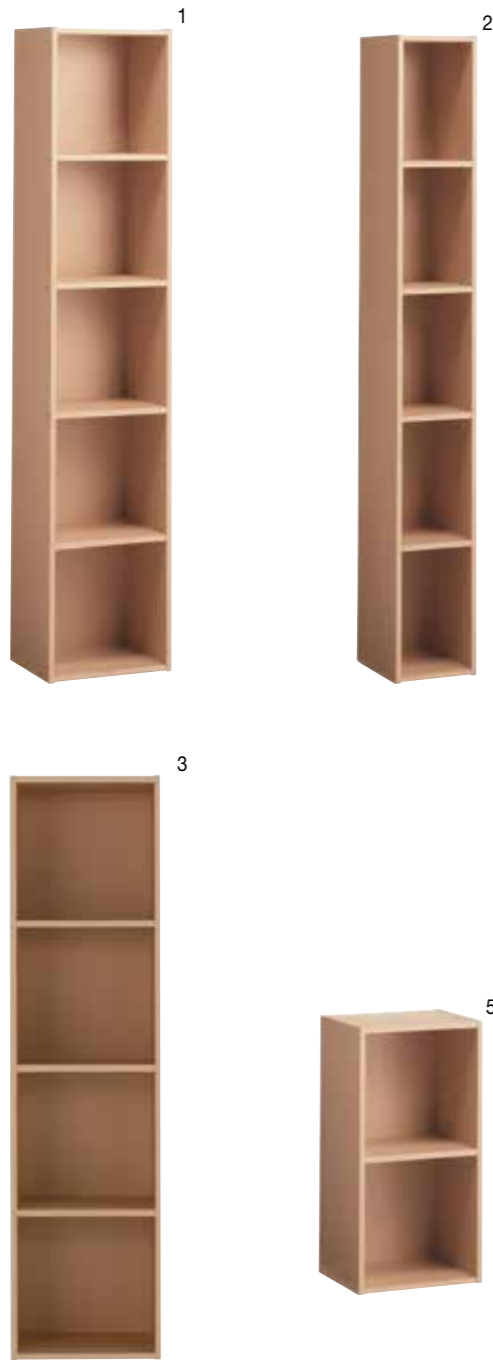

- Pulp Board Box / Beige**
- 1** **47549201** Vertically / horizontally A4-sized, 5-tier **\$63.00**  
 W 37.5 x D 29 x H 180 cm  
 Inside dimensions of each shelf: W 34 x D 27.5 x H 34 cm  
 Withstand load of fixed shelf: 15 kg per compartment, 40 kg total  
 Perfectly accommodates A4-sized documents both vertically and horizontally.
- 2** **18121717** Slim-sized, 5-tier **\$56.00**  
 W 25 x D 29 x H 180 cm  
 Inside dimensions of each shelf: W 21.5 x D 27.5 x H 34 cm  
 Withstand load of fixed shelf: 15 kg per compartment, 40 kg total  
 This slim type will fit in small spaces around the house. This unit can be used upright or on its side.
- Pulp Board Box / Beige**
- 3** **18511341** Vertically / horizontally A4-sized, 4-tier **\$53.00**  
 W 37.5 x D 29 x H 144 cm  
 Inside dimensions of each shelf: W 34 x D 27.5 x H 34 cm  
 Withstand load of fixed shelf: 15 kg per compartment, 35 kg total
- 18511358** Slim-sized, 4-tier **\$49.00**  
 W 25 x D 29 x H 144 cm  
 Inside dimensions of each shelf: W 21.5 x D 27.5 x H 34 cm  
 Withstand load of fixed shelf: 15 kg per compartment, 35 kg total
- Pulp Board Box / Beige**
- 4** **47549195** Vertically / horizontally A4-sized, 3-tier **\$43.00**  
 W 37.5 x D 29 x H 109 cm  
 Inside dimensions of each shelf: W 34 x D 27.5 x H 34 cm  
 Withstand load of fixed shelf: 15 kg per compartment, 25 kg total
- 18121700** Slim-sized, 3-tier **\$39.00**  
 W 25 x D 29 x H 109 cm  
 Inside dimensions of each shelf: W 21.5 x D 27.5 x H 34 cm  
 Withstand load of fixed shelf: 15 kg per compartment, 25 kg total
- Pulp Board Box / Beige**
- 5** **47549188** Vertically / horizontally A4-sized, 2-tier **\$26.00**  
 W 37.5 x D 29 x H 73 cm  
 Inside dimensions of each shelf: W 34 x D 27.5 x H 34 cm  
 Withstand load of fixed shelf: 15 kg per compartment, 20 kg total
- 18121694** Slim-sized, 2-tier **\$23.00**  
 W 25 x D 29 x H 73 cm  
 Inside dimensions of each shelf: W 21.5 x D 27.5 x H 34 cm  
 Withstand load of fixed shelf: 15 kg per compartment, 20 kg total  
 \* The 2-tier models cannot be stacked due to the lack of stability.

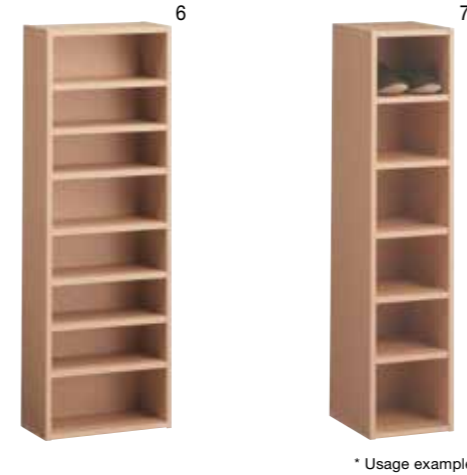

\* Usage example

- Pulp Board Box / Beige**
- 6** **18121724** Multi rack **\$53.00**  
 W 37.5 x D 17.5 x H 109 cm  
 Inside dimensions of each shelf: W 34 x D 16 cm  
 Adjustable shelf: 6 shelves (increment of 2.9 cm)  
 Fixed shelf: 1 shelf (4th tier from top)  
 Withstand load: 8 kg per compartment, 25 kg total
- 7** **18121731** Multi narrow rack **\$49.00**  
 W 25 x D 29 x H 109 cm  
 Inside dimensions of each shelf: W 21.5 x D 27.5 cm  
 Adjustable shelf: 3 shelves (increment of 2.9 cm)  
 Fixed shelf: 2 shelves (2nd and 4th tier from top)  
 Withstand load: 8 kg per compartment, 25 kg total
- The height of the Free rack, Multi rack, and Pulp Board Box / Beige / 3-tier have been made uniform to use alongside each other.



Horizontal use



Vertical use

- Pulp Board Box With Caster / Beige (for vertical / horizontal use)**
- 61789712** **\$79.00**
- When used vertically:  
 Approx. W 62 (including handle) x D 29 x H 79 cm  
 Inside dimensions of each compartment:  
 nine different widths (approx. 16-37 cm) x D 27 x H 34 cm  
 Withstand load: 15 kg for fixed compartment, 20 kg total
- When used horizontally:  
 Approx. W 76 (including handle) x D 29 x H 64 cm  
 Inside dimensions of each compartment:  
 approx. W 34 x D 27 x nine different heights (approx. 16-37 cm)  
 Withstand load: 15 kg for fixed shelf, 8 kg per adjustable shelf, 20 kg total
- Shelf adjustment increment 3 cm
- The size and specifications have been reviewed. This unit can be used upright or on its side to suit uses in various spaces. The method for fixing the adjustable shelves have been modified from shelf supporting joints to the use of hanger bars to make it more difficult for the shelf to fall out. This unit is equipped with casters for easy transport.



When used horizontally (When placed inside a Japanese style closet)      When used vertically (When placed inside a closet)

## Metal Joint Fittings For Pulp Board Boxes

- 10** **18960941** Set of 2 **\$3.90**  
 Metal fittings to prevent tipping when pulp board boxes are placed sideways. Units placed sideways can be stacked up to five tiers by using these metal joint fittings.

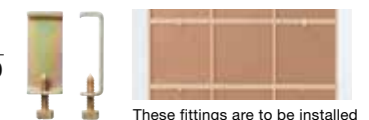

These fittings are to be installed on every other compartment in the lateral direction.

**Notes regarding the metal fittings**  
 When placing units sideways, be sure to attach the Metal Joint Fittings For Pulp Board Boxes as shown on the left on the rear side of the units in order to prevent tipping.

\* These metal joint fittings can only be used with the 3-tier, 4-tier, and 5-tier models.



# Hanging Storage

You can use space effectively by hanging up a variety of items to store. These items come with a hanger, so you can hang them up wherever, or remove it for carrying.



## Portable storage items that create a storage space wherever you can hang them.

In addition to keeping your closet organised, these items can be hung anywhere to create a convenient storage space. The hanger can also be removed for portability.



- Hanging Storage Pocket For Small Items**  
[38369554] \$29.90  
Approx. W 41 x D 1.5 x H 80 cm
- Hanging Storage Pocket For Shirts**  
[38369578] \$39.00  
Approx. W 41 x D 0.5 x H 80 cm
- Hanging Storage Pocket With Zipper**  
[38369585] \$59.00  
Approx. W 41 x D 3 x H 80 cm
- Hanging Storage Pocket For Bags**  
[38369567] \$36.00  
Approx. W 41 x D 0.5 x H 80 cm
- Hanging Storage Pocket With Handle**  
[38369592] \$28.90  
Approx. W 41 x D 12.5 x H 45 cm  
Comes with a hook for closing the pocket.



Back mesh pocket



Back loops



The pockets with zippers have gussets.



The opening is large, so taking things in and out is easy.

Withstand load: 3 kg

## Example usage for hanging storage

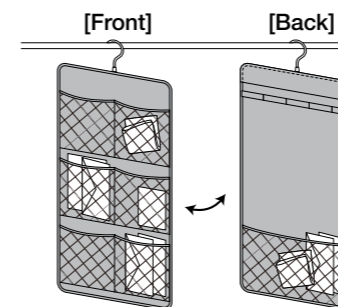

**Pocket for small items**  
This type is to store small items like postcards and handkerchiefs. There is a mesh pocket and loops attached to the back.

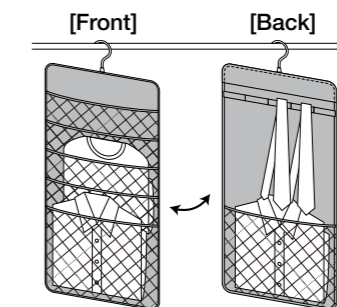

**Pocket for shirts**  
This type is to store dress shirts and neckties. There is a mesh pocket and loops attached to the back.

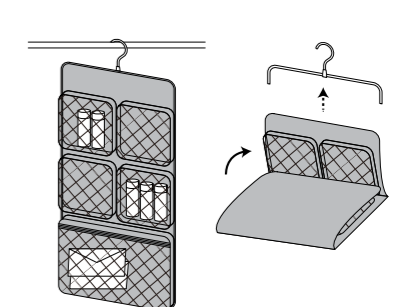

**Pocket with zipper**  
The zippered pockets make organisation easy. Thanks to the zippers, the items don't fall off and can be carried around by removing the hanger.

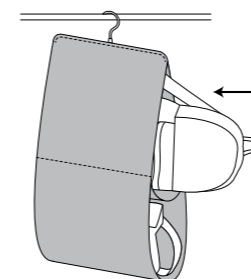

**Pocket for bags**  
This item can store bags of a variety of shapes. There is an upper and lower pocket.

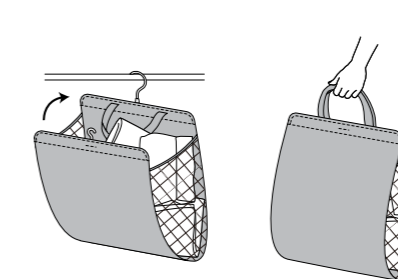

**Pocket with handle**  
Things like clothes and towels can be put in this item. It has a handle that is convenient for carrying.

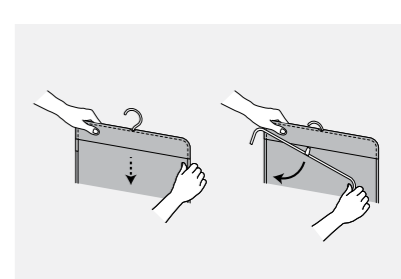

**Removing the hanger (all items)**  
Move the hanger downward and pull it out while rotating.

# Side Furniture Mirrors

Side furniture and mirror shaped in a minimalistic manner to add the joy of coordination with other furniture. Each has been designed by taking advantages of each material.



\* Usage example

**Compact Magazine Rack**  
1 **37287556** **\$63.00**  
W 32 x D 32 x H 20.5 cm  
Magazine rack made by combining a polystone base with steel bars.

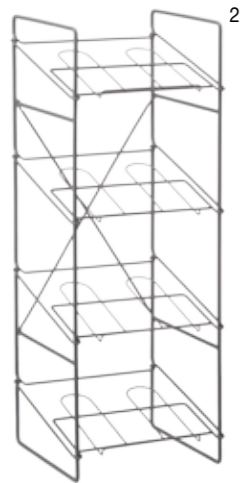

\* Usage example

**Compact Shoe Rack**  
2 **37287587** **\$99.00**  
W 31 x D 30 x H 83 cm  
This shoe rack can be assembled easily.



**Compact Umbrella Stand**  
3 **37287570** **\$79.00**  
W 16 x D 16 x H 71 cm  
It can be used not only for standing umbrellas but also for hanging folding umbrellas.



**Steel Tray Stand**  
4 **38326458** **\$59.00**  
W 45.5 x D 34.5 x H 51.5cm  
A tray stand which can be used in combination with the separately sold Wooden Tray. This unit can be used upright or on its side.



**Wooden Tray / Ash Wood**  
5 **61010502** **\$23.00**  
Approx. W 46 x D 35 x H 1.5 cm  
An LVL tray made of ash which is common as a material for furniture.



**Pine Folding Table**  
2 **18499441** **\$99.00**  
W 80 x D 50 x H 70 cm (Thickness when folded: 12.5 cm)

**Pine Folding Low Table**  
3 **18499434** **\$89.00**  
W 80 x D 50 x H 35 cm (Thickness when folded: 6.5 cm)  
This table can be folded for compact storage.



When folded



Reverse side



Combination with a chair



**Beech Coat Stand**  
1 **61013107** **\$99.00**  
W 48 x D 42 x H 173.5 cm  
Withstand load: 15 kg  
A three-legged coat hanger with a small footprint. This product can be taken home as it is designed to be assembled.  
\*Please be sure to follow the withstand load. Make sure that children do not hang on this product.

**Pine Mirror**  
2 **18122868** **\$99.00**  
W 36 x D 50 x H 145 cm  
Pine is soft and easily gets scratched due to the nature of the wood, however, this will not affect daily use.

**Coat Rack**  
3 **15874873** Oak **\$169.00**  
W 44 x D 53.5 x H 150.5 cm  
Withstand load: 10 kg for shelf, 10 kg for hanger  
Equipped with a shelf board for storage of bags and small items. Designed to match the angle of the large mirror for a neat appearance when placed alongside each other.

**Mirror / Large**  
4 **15874880** Oak **\$189.00**  
W 44 x D 33 x H 150.5 cm  
Natural wood is used for the frame. It is sturdy and can be used for a long time. A large mirror is used.



\* Usage example

**Aluminium Tray Mirror**  
5 **15574940** Large **\$43.00**  
W 20.5 x D 18 x H 40-51 cm  
**15574957** Small **\$33.00**  
W 17 x D 14 x H 27 cm  
Both Large and Small models are a double-sided mirror while one side is a magnifying mirror.



Buri Storage Units P52 / Polypropylene Stand File Box P58

## Storage Items



**Polypropylene Storage Box** ..... 44

Storage boxes sized specifically to organise clothing. Choose the right depth and width to fit the space you have.



**Polypropylene Storage Case** ..... 46

Storage cases sized to hold small items and papers. Designed to fit neatly into MUJI storage furniture.



**Bac Bac Storage Units** ..... 54

Storage boxes carefully woven from rope made from the bark of bac bac trees.



**Cotton Linen Polyester Storage Units** ..... 55

Foldable storage boxes made from fabric coated on the inside.



**Polypropylene Storage Stocker** ..... 48

Wheeled storage stockers in narrow widths for efficient use of narrow spaces.



**Polypropylene Sturdy Storage Box** ..... 51

Durable, easy-to-carry storage boxes that can be used indoors or outdoors.



**Stainless Steel Storage Units** ..... 57

Stackable wire baskets that are highly durable.



**Acrylic Storage Units** ..... 59

Versatile storage units suitable for organising small items such as stationery and jewellery.



**Buri Storage Units** ..... 52

Storage boxes handwoven to highlight the natural texture of the high quality buri materials.



**Rattan Storage Units** ..... 53

Storage boxes handwoven of smooth, sleek rattan.

# Polypropylene Storage Units

There is a wide range of cases, stockers, wagons, and boxes.  
Flexibly combine the items and sizes according to your purpose and available space.

## Polypropylene Storage Box / Wide Type (approx. W 40 x D 65 cm)



**Polypropylene Storage Box / Wide Type**  
**15112081** L **\$29.00**

Approx. W 40 x D 65 x H 30 cm  
Inside dimensions: approx. W 33 x D 59 x H 24.5 cm  
Stacking limit: 6 units  
Casters attachable (sold separately)



**15112098** M **\$23.00**

Approx. W 40 x D 65 x H 24 cm  
Inside dimensions: approx. W 33.5 x D 59 x H 18.5 cm  
Stacking limit: 7 units  
Casters attachable (sold separately)



**15112104** S **\$19.00**

Approx. W 40 x D 65 x H 18 cm  
Inside dimensions: approx. W 33.5 x D 59 x H 12.5 cm  
Stacking limit: 8 units  
Casters attachable (sold separately)  
Withstand load: approx. 7 kg (with casters: approx. 3.5 kg)



This type of drawer unit is designed with increased depth suitable for Japanese-style closets.

## Polypropylene Storage Box / Wide Type (approx. W 44 x D 55 cm)



**Polypropylene Storage Box / Wide Type**  
**15199693** L **\$29.00**

Approx. W 44 x D 55 x H 30 cm  
Inside dimensions: approx. W 38 x D 49.5 x H 24.5 cm  
Stacking limit: 6 units  
Casters attachable (sold separately)



**15199709** M **\$23.00**

Approx. W 44 x D 55 x H 24 cm  
Inside dimensions: approx. W 38.5 x D 49.5 x H 18.5 cm  
Stacking limit: 7 units  
Casters attachable (sold separately)



**15236640** S **\$19.00**

Approx. W 44 x D 55 x H 18 cm  
Inside dimensions: approx. W 38.5 x D 49.5 x H 12.5 cm  
Stacking limit: 8 units  
Casters attachable (sold separately)  
Withstand load: approx. 7 kg (with casters: approx. 3.5 kg)



This Storage Box is the perfect size for typical closets.

## Polypropylene Storage Box / Drawer Type (approx. W 34 x D 44.5 cm)



**Polypropylene Storage Box / Drawer Type**  
**18816156** L **\$23.00**

Approx. W 34 x D 44.5 x H 30 cm  
Inside dimensions: approx. W 28.5 x D 40 x H 25.5 cm  
Stacking limit: 6 units  
Casters attachable (sold separately)



**18816163** M **\$19.00**

Approx. W 34 x D 44.5 x H 24 cm  
Inside dimensions: approx. W 28.5 x D 40 x H 19.5 cm  
Stacking limit: 7 units  
Casters attachable (sold separately)



**18816170** S **\$16.00**

Approx. W 34 x D 44.5 x H 18 cm  
Inside dimensions: approx. W 29 x D 40 x H 13.5 cm  
Stacking limit: 9 units  
Casters attachable (sold separately)  
Withstand load: approx. 5 kg (with casters: approx. 3.0kg)



Store shirts, underwear, and handkerchiefs in shallower cases. Polystyrene Partitions are available for your convenience. Deeper cases are recommended for autumn / winter clothes, towels, and other heavier fabrics.

## Example combination of Polypropylene Storage Box (approx. D 44.5 cm) series

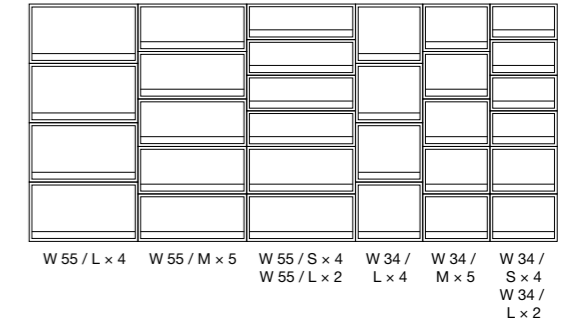

## Translucent boxes with natural colour of the material

The trend for polypropylene products was to use colourful design schemes. However, MUJI developed uncoloured cases by eliminating the colouring process from the production process. Not only does the omission of the colouring process reduce costs, but it also allows you to see what's in the drawers while obscuring the contents with the cloudiness to maintain neat looks. Large cases are available in four series W 40 x D 65, W 44 x D 55, W 34 x D 44.5, and W 55 x D 44.5. Mix and match the items from a variety of dimensions according to the size of your storage space. The cases feature drawers, which prevents dust from accumulating. Casters can be attached for easy mobility.

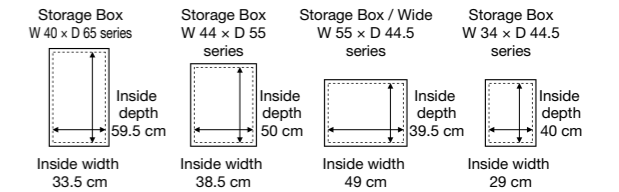

## Polypropylene Storage Box / Wide Type (approx. W 55 x D 44.5 cm)



**Polypropylene Storage Box / Wide Type**  
**18182800** L **\$36.00**

Approx. W 55 x D 44.5 x H 30 cm  
Inside dimensions: approx. W 48.5 x D 39 x H 25 cm  
Withstand load: approx. 2.5 kg (with casters: approx. 2.5 kg)  
Stacking limit: 4 units  
Casters attachable (sold separately)



**47266740** M **\$29.00**

Approx. W 55 x D 44.5 x H 24 cm  
Inside dimensions: approx. W 49 x D 39 x H 19.5 cm  
Withstand load: approx. 3 kg (with casters: approx. 3.0 kg)  
Stacking limit: 5 units  
Casters attachable (sold separately)



**47266733** S **\$23.00**

Approx. W 55 x D 44.5 x H 18 cm  
Inside dimensions: approx. W 49 x D 39 x H 13.5 cm  
Withstand load: approx. 3 kg (with casters: approx. 3.0 kg)  
Stacking limit: 5 units  
Casters attachable (sold separately)



This wide drawer type can store shirts and sweaters side-by-side.



**Polypropylene Storage Box / Wide Type**  
**18510269** L / 4 Drawers **\$99.00**

Approx. W 55 x D 44.5 x H 90 cm  
Stacking limit: 5 drawers



**18510252** L / 3 Drawers **\$73.00**

Approx. W 55 x D 44.5 x H 67.5 cm  
Stacking limit: 5 drawers  
Inside dimensions: approx. W 49 x D 39.5 x H 19.5 cm  
Withstand load: approx. 9 kg (approx. 3 kg per drawer) (with casters: approx. 3 kg per drawer)  
Casters attachable (sold separately)



Wide drawer type polypropylene storage cases are stacked together. An extra wide-type drawer can be stacked.  
\* Do not disassemble or add a drawer.



Usage example Bottom wheel

## Polystyrene Partition

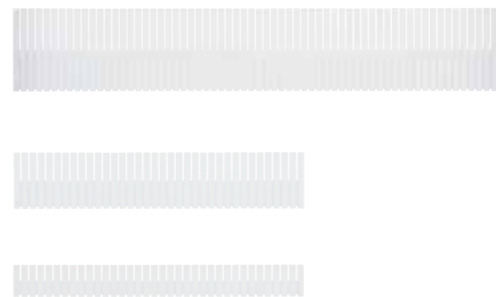

## Polystyrene Partition

**38369622** L set of 4 **\$14.90**

Approx. W 65.5 x D 0.2 x H 11 cm

**38369615** M set of 5 **\$7.90**

Approx. W 36 x D 0.2 x H 7 cm

**38369608** S set of 5 **\$5.90**

Approx. W 36 x D 0.2 x H 4 cm

Fold and combine according to the size of your desired partition.

## Polystyrene Partition - Usage Examples

Use them to divide your polypropylene case as needed. For stationary, use a shallow storage case. To store your t-shirts and handkerchiefs, divide the case into sections to find them easily.



Usage Example / Large Usage Example / Medium Usage Example / Small

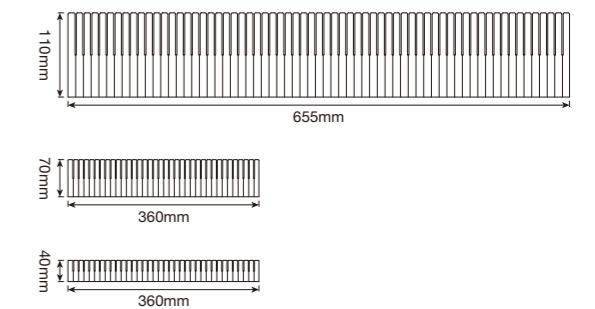

\* To ensure safety, please follow the stacking limit and withstand load requirements.

\* The polypropylene cases have slight differences in size due to the characteristics of material. When stacked, each case may differ slightly in height.

\* To ensure safety, please follow the stacking limit and withstand load requirements.

\* The polypropylene cases have slight differences in size due to the characteristics of material. When stacked, each case may differ slightly in height.

**Polypropylene Storage Case / Deep** (approx. W 26 x D 37 cm / Half-size: approx. W 14 x D 37 cm)

 **Polypropylene Storage Case / Deep**  
**76749028** 2 Drawers (with partition) **\$23.00**  
 Approx. W 26 x D 37 x H 17.5 cm  
 Inside dimensions: approx. W 10.5 x D 33.5 x H 14 cm  
 Withstand load (with / without casters): approx. 2 kg per drawer, approx. 2 kg on top board



 **37192447** 1 Drawer **\$16.00**  
 Approx. W 26 x D 37 x H 17.5 cm  
 Inside dimensions: approx. W 22 x D 33.5 x H 14 cm  
 Withstand load (with / without casters): approx. 2 kg per drawer, approx. 2 kg on top board  
 Stacking limit: 6 units  
 Casters attachable (sold separately)



 **Polypropylene Storage Case / Deep**  
**76749035** 1 Drawer (with partition) **\$14.90**  
 Approx. W 14 x D 37 x H 17.5 cm  
 Inside dimensions: approx. W 10.5 x D 33.5 x H 14 cm  
 Withstand load (with / without casters): approx. 2 kg per drawer, approx. 2 kg on top board  
 Stacking limit: 4 units  
 Casters attachable (sold separately)

This drawer is a narrower version to fit into smaller spaces.



**Polypropylene Storage Case / Shallow** (approx. W 26 x D 37 cm / Half-size: approx. W 14 x D 37 cm)

 **Polypropylene Storage Case / Shallow**  
**76748984** 2 Drawers (with partition) **\$19.00**  
 Approx. W 26 x D 37 x H 12 cm  
 Inside dimensions: approx. W 10.5 x D 34 x H 8.5 cm  
 Withstand load (with / without casters): approx. 1.5 kg per drawer, approx. 2 kg on top board



 **37192423** 1 Drawer **\$14.90**  
 Approx. W 26 x D 37 x H 12 cm  
 Inside dimensions: approx. W 22.5 x D 34 x H 8.5 cm  
 Withstand load (with / without casters): approx. 3 kg per drawer, approx. 2 kg on top board  
 Stacking limit: 10 units  
 Casters attachable (sold separately)



 **Polypropylene Storage Case / Shallow**  
**76749042** 1 Drawer (with partition) **\$13.00**  
 Approx. W 14 x D 37 x H 12 cm  
 Inside dimensions: approx. W 10.5 x D 34 x H 8.5 cm  
 Withstand load (with / without casters): approx. 1.5 kg per drawer, approx. 2 kg on top board  
 Stacking limit: 6 units  
 Casters attachable (sold separately)

This drawer is a narrower version to fit into smaller spaces.



 **Polypropylene Storage Case / Shallow**  
**76749004** 6 Drawers **\$49.00**  
 Approx. W 26 x D 37 x H 32.5 cm  
 Inside dimensions: approx. W 10.5 x D 34 x H 8.5 cm  
 Withstand load (with / without casters): approx. 1.5 kg per drawer, approx. 2 kg on top board



 **37192430** 3 Drawers **\$29.00**  
 Approx. W 26 x D 37 x H 32.5 cm  
 Inside dimensions: approx. W 22.5 x D 34 x H 8.5 cm  
 Withstand load (with / without casters): approx. 3 kg per drawer, approx. 2 kg on top board



Stacking limit: 3 units  
 Casters attachable (sold separately)

**Polypropylene Storage Case / Extra Shallow** (approx. W 26 x D 37 cm)

 **Polypropylene Storage Case / Extra Shallow**  
**76749073** 2 Drawers **\$19.00**  
 Approx. W 26 x D 37 x H 16.5 cm  
 Stacking limit: 7 units

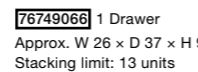
 **76749066** 1 Drawer **\$13.00**  
 Approx. W 26 x D 37 x H 9 cm  
 Stacking limit: 13 units

Inside dimensions: approx. W 22.5 x D 34 x H 5.5 cm  
 Withstand load (with / without casters): approx. 2 kg per drawer, approx. 2 kg on top board  
 Casters attachable (sold separately)

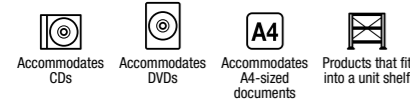

- Older models can be stacked on the new models. (Please note that a new model cannot be stacked on older models.)
- Older models are replaced by new models as of March 2006.
- Placing items weighing more than the recommended withstand load on the top board may warp the polypropylene case, which can affect the opening and closing of the drawer. (with the exception of when combining a Polypropylene Storage Case / Steel Frame with Polypropylene Storage Cases).

**Polypropylene Storage Case / Wide**

 **Polypropylene Storage Case / Wide / Extra Shallow**  
**15253753** **\$14.90**  
 W 37 x D 26 x H 9 cm  
 Inside dimensions: approx. W 34 x D 22.5 x H 5.5 cm  
 Withstand load (with / without casters): approx. 1 kg per drawer, approx. 5 kg on top board (with reinforcement bar)  
 Stacking limit: 13 units

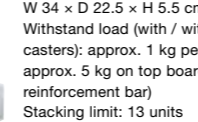
 **15253777** 2 Drawers **\$19.00**  
 W 37 x D 26 x H 9 cm  
 Inside dimensions: approx. W 16.5 x D 22.5 x H 5.5 cm  
 Withstand load (with / without casters): approx. 0.5 kg per drawer, approx. 5 kg on top board (with reinforcement bar)  
 Stacking limit: 13 units



Casters attachable (sold separately)

\* This item can be combined with Polypropylene Storage Rack on P80.

Please note that above wide drawer-type polypropylene cases cannot be stacked with other drawer-type polypropylene cases.

 **Polypropylene Storage Case / Wide**  
**15253784** Shallow **\$16.00**  
 W 37 x D 26 x H 12 cm  
 Inside dimensions: approx. W 33.5 x D 22.5 x H 8.5 cm  
 Withstand load (with / without casters): approx. 1.5 kg per drawer, approx. 5 kg on top board (with reinforcement bar)  
 Stacking limit: 10 units

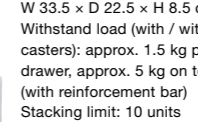
 **15253791** Deep **\$17.90**  
 W 37 x D 26 x H 17.5 cm  
 Inside dimensions: approx. W 33 x D 22.5 x H 14 cm  
 Withstand load (with / without casters): approx. 2 kg per drawer, approx. 5 kg on top board (with reinforcement bar)  
 Stacking limit: 6 units



Casters attachable (sold separately)



Usage example

**Polypropylene Carry Box with Lock**

 **Polypropylene Storage Carry Box / With Lock** (approx. W 36 x D 52 cm)  
**18723713** L **\$23.00**  
 Approx. W 36 x D 52 x H 33 cm  
 Inside dimensions: approx. W 30 x D 42 x H 31 cm  
 Withstand load (with / without casters): approx. 9 kg  
 Stacking limit: 5 units

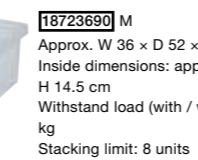
 **18723690** M **\$19.00**  
 Approx. W 36 x D 52 x H 16.5 cm  
 Inside dimensions: approx. W 31.5 x D 43 x H 14.5 cm  
 Withstand load (with / without casters): approx. 7 kg  
 Stacking limit: 8 units



Casters attachable (sold separately)

 **Polypropylene Storage Carry Box / With Lock / S** (approx. W 25.5 x D 37 cm)  
**61793030** Deep **\$17.90**  
 Approx. W 25.5 x D 37 x H 33 cm  
 Inside dimensions: approx. W 17.5 x D 27 x H 31 cm  
 Withstand load: approx. 8 kg  
 Stacking limit: 5 units

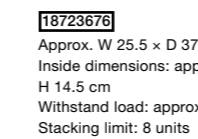
 **18723676** **\$14.90**  
 Approx. W 25.5 x D 37 x H 16.5 cm  
 Inside dimensions: approx. W 21 x D 30.5 x H 14.5 cm  
 Withstand load: approx. 5 kg  
 Stacking limit: 8 units

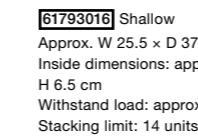
 **61793016** Shallow **\$11.00**  
 Approx. W 25.5 x D 37 x H 8.5 cm  
 Inside dimensions: approx. W 21.5 x D 31 x H 6.5 cm  
 Withstand load: approx. 4 kg  
 Stacking limit: 14 units



The lock function prevents the lid from coming off and spilling what is kept inside. This item can store everything from small objects to bulky items.

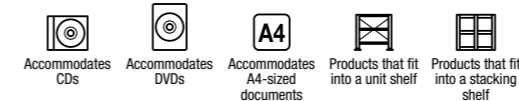

**Polypropylene Carry Box**

 **Polypropylene Carry Box**  
**47807493** L **\$19.00**  
 Approx. W 36 x D 51 x H 33 cm  
 Inside dimensions: approx. W 30 x D 42 x H 31 cm  
 Withstand load (with / without casters): approx. 9 kg  
 Stacking limit: 5 units

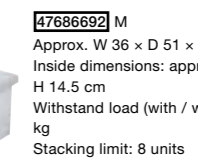
 **47686692** M **\$16.00**  
 Approx. W 36 x D 51 x H 16.5 cm  
 Inside dimensions: approx. W 31.5 x D 43 x H 14.5 cm  
 Withstand load (with / without casters): approx. 7 kg  
 Stacking limit: 8 units

Casters attachable (sold separately)



 **47686685** S **\$11.00**  
 Approx. W 25.5 x D 36 x H 16.5 cm  
 Inside dimensions: approx. W 21 x D 30.5 x H 14.5 cm  
 Withstand load: approx. 5 kg  
 Stacking limit: 8 units





### Polypropylene Storage Stocker



**Polypropylene Storage Case / With Caster**

**15521821** \$46.00  
 Approx. W 18 x D 40 x H 83 cm  
 Inside dimensions: (Drawer) approx.  
 W 13 x D 35.5 x H 17 cm



**Polypropylene Stocker / With Caster / 1**

**15880188** \$49.00  
 Approx. W 18 x D 40 x H 83 cm  
 Inside dimensions: (Drawer) approx.  
 W 13 x D 35.5 x H 17 cm  
 (Deep drawer) approx.  
 W 12.5 x D 35 x H 26.5 cm



**Polypropylene Stocker / With Caster / 2**

**15880195** \$56.00  
 Approx. W 18 x D 40 x H 83 cm  
 Inside dimensions: (Drawer) approx.  
 W 13 x D 35.5 x H 17 cm  
 (Deep drawer) approx.  
 W 12.5 x D 35 x H 26.5 cm  
 (Shallow drawer) approx.  
 W 13 x D 36 x H 7 cm



**Polypropylene Stocker / With Caster / 3**

**15880201** \$76.00  
 Approx. W 18 x D 40 x H 122 cm  
 Inside dimensions: (Drawer) approx.  
 W 13 x D 35.5 x H 17 cm  
 (Deep drawer) approx.  
 W 12.5 x D 35 x H 26.5 cm  
 (Shallow drawer) approx.  
 W 13 x D 36 x H 7 cm



**Polypropylene Stocker / With Caster / 4**

**15880218** \$79.00  
 Approx. W 18 x D 40 x H 122 cm  
 Inside dimensions: (Drawer) approx.  
 W 13 x D 35.5 x H 17 cm  
 (Deep drawer) approx.  
 W 12.5 x D 35 x H 26.5 cm  
 (Shallow drawer) approx.  
 W 13 x D 36 x H 7 cm



These items cannot be disassembled.

### The storage stocker series is combinations of the following three drawers.

Additional storage units can be stacked up to about 122 cm in height in any combination.

	Weight limit (including when casters are attached)			Storable amount per drawer
	Storage per drawer	Withstand load of top board	Total	
Additional Drawer <b>47721584</b>	Approx. 5 kg	Approx. 3 kg	Approx. 30 kg	About ten 350 ml cans
Additional Drawer <b>15880171</b> Shallow	Approx. 2.5 kg	Approx. 3 kg	Approx. 30 kg	
Additional Drawer <b>15880164</b> Deep	Approx. 5 kg	Approx. 3 kg	Approx. 30 kg	About four 1000 ml plastic bottles

\* The height limit includes the height of the casters (approx. 4.2 cm) when attached.  
 \* Using the product with lighter objects stored in the upper drawers and heavy ones in the bottom drawers can increase the stability and improve the usability.

### Polypropylene Additional Drawer



**Polypropylene Additional Drawer**

**15880164** Deep \$19.00 **47721584** \$13.00 **15880171** Shallow \$11.00  
 Approx. W 18 x D 40 x H 30.5 cm  
 Inside dimensions: approx.  
 W 12.5 x D 35 x H 26.5 cm  
 Stacking limit: 4 units



\* Remove the top board or casters to add Additional Drawers and create your own original set.  
 \* Can be stacked up to about 122 cm in height in any combination.

Please note the set cannot be disassembled again once it has been put together.



\*1 Limit of additional storage (adding from the top): shallow (15880171): up to 3 additional tiers, drawers (47721584): add up to 2, deep (15880164): add 1



**Polypropylene Shelf Wagon / With Casters**

**15253807** 3 tiers \$29.00  
 W 29 x D 41.5 x H 83 cm  
 Storage inside dimensions: approx. W 26 x D 37 x H 22 cm  
 (Top board inside dimensions: W 26 x D 37.5 cm)  
 Withstand load: (Total) approx. 8 kg (per drawer) approx. 2 kg

This three-compartment wagon has been modified for better accessibility. This wagon enables effective use of narrow spaces.

### Polypropylene Stocker series - storage capacity and size chart

The Additional Drawers can be stacked to a height of approximately 122 cm regardless of the combination of items.

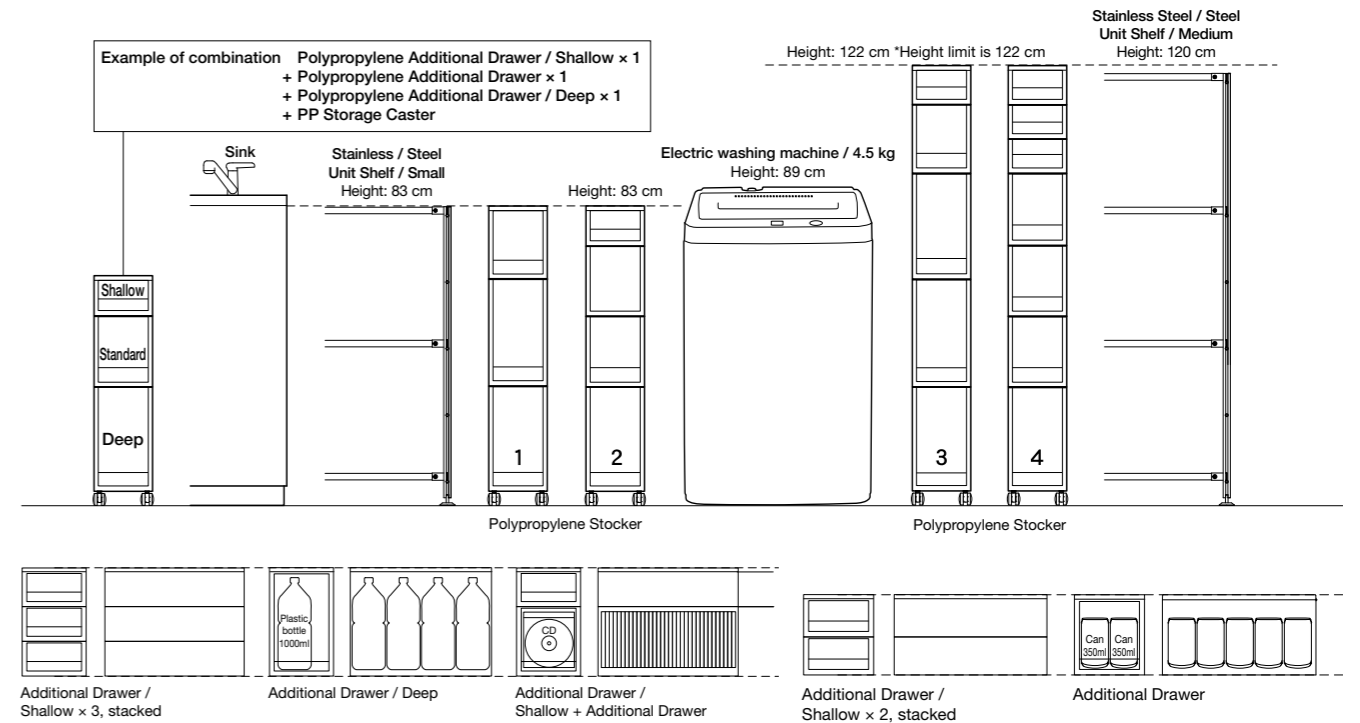

**Polypropylene Storage Case / Stopper**

**1** **47554908** S / Set of 4 **2** **47554892** L / Set of 4  
 Each \$5.90

Silicone rubber  
 These stoppers are attachable on Polypropylene cases such as Storage Case (W 44 x D 65, W 34 x D 44.5, and W 55 x D 44.5 cm)

\* Using the stoppers increases the total height of all drawer type polypropylene cases by approx. 1.5 mm and other products by a maximum of 4 mm.

#### Products that can be used with Stopper / S

All Polypropylene Storage Case (L, M)  
 Polypropylene Carry Box Foldable (L)  
 All Polypropylene Stockers and all Additional Drawers  
 Polypropylene Dust Box With Choice Of Lid (Large) (Small)  
 All Polypropylene Storage Cases  
 Polypropylene Storage Wagon With Caster  
 All Polypropylene Storage Cases / Wide  
 All Polypropylene Storage Carry Box With Lock (W 25.5 x D 37)  
 All Polypropylene Storage Rack

#### Products that can be used with Stopper / L

All Polypropylene Storage Box (approx. W 40 x D 65 cm)  
 All Polypropylene Storage Box (approx. W 44 x D 55 cm)  
 Polypropylene Storage Box (approx. W 34 x D 44.5 cm)  
 Polypropylene Storage Box / Wide (approx. W 55 x D 44.5 cm)



**Polypropylene Storage Box / Caster**

**15523788** Set of 4 \$6.30  
 Resin moulded product

These casters can be easily attached to the bottom of the following polypropylene cases by inserting the connectors into the holes.

\* Using the casters increases the total height by approx. 3.8 to 4.2 cm (exact height-increase depends on the case used).  
 \* Do not use casters on tatami, cushion floors, or other soft flooring in order to prevent damage to the floor.

#### Products that can be used with Polypropylene Storage Box / Caster

Polypropylene Carry Box (L, M)  
 Polypropylene Carry Box Foldable (L)  
 All Polypropylene Storage Box (approx. W 40 x D 65 cm)  
 All Polypropylene Storage Box (approx. W 44 x D 55 cm)  
 Polypropylene Storage Box (approx. W 34 x D 44.5 cm)  
 Polypropylene Storage Box / Wide (approx. W 55 x D 44.5 cm)  
 Polypropylene Storage Case With Caster  
 All Polypropylene Stockers and all Additional Drawer  
 Polypropylene Dust Box With Choice Of Lid (Large) (Small)  
 All Polypropylene Storage Cases  
 Polypropylene Storage Wagon With Caster  
 All Polypropylene Storage Cases / Wide  
 All Polypropylene Storage Carry Box With Lock (W 25.5 x D 37)  
 All Polypropylene Storage Rack



**Height Adjustable Non-woven Fabric Separation Case**

**38309772** L / 2Pcs \$16.00 **38309765** M / 2Pcs \$13.90 **38309758** S / 2Pcs \$11.60  
 Approx. W 22.5 x D 32.5 x H 21 cm  
 Approx. W 15 x D 32.5 x H 21 cm  
 Approx. W 11 x D 32.5 x H 21 cm

Use these cases to partition inside of a variety of storage units. Height can be adjusted by folding the top edges. They are also useful as liners for natural material storage units.



Usage example

### Usage examples of Height Adjustable Non-woven Fabric Separation Case

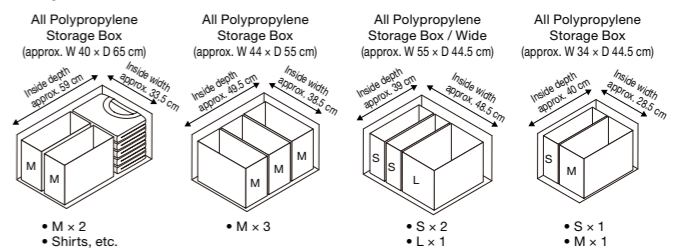

Polypropylene Storage Rack



Polypropylene Storage Rack

<b>37150720</b> L	<b>\$16.00</b>	<b>37150713</b> M	<b>\$13.90</b>	<b>37150621</b> S	<b>\$11.00</b>
Approx. W 37 x D 26 x H 26 cm Effective inside dimensions: [Top] approx. W 33 x D 22.5 x H 24 cm [Bottom] approx. W 33 x D 22.5 x H 1.5 cm Withstand load: approx. 5 kg Stacking limit: 4 units Casters attachable (sold separately)		Approx. W 37 x D 26 x H 17.5 cm Effective inside dimensions: [Top] approx. W 33 x D 22.5 x H 15.5 cm [Bottom] approx. W 33 x D 22.5 x H 1.5 cm Withstand load: approx. 4 kg Stacking limit: 6 units		Approx. W 37 x D 26 x H 9 cm Effective inside dimensions: [Top] approx. W 33 x D 24 x H 6.5 cm [Bottom] approx. W 33 x D 22.5 x H 1.5 cm Withstand load: approx. 3 kg Stacking limit: 13 units	

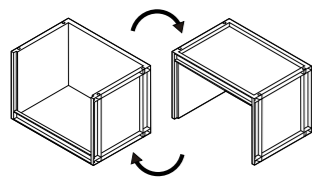

Rack can also be used upside down.

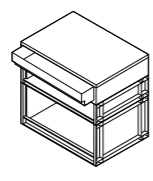

Rack can be stacked with Polypropylene Storage Case / Wide and other sizes.

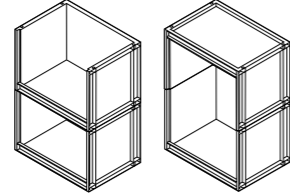

Racks can be stacked together in different orientations.

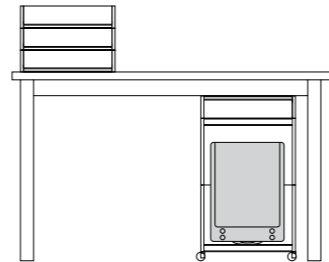

The racks can be used as storage around a desk. (Usage example: school bag)

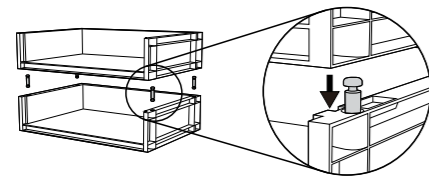

When stacking Polypropylene Racks to top of each other, make sure to properly secure the joint parts in all four holes at the corners of each rack.  
\* Use the joint parts also when stacking a Polypropylene Storage Case / Wide on top of a rack.

Accessories: joint parts (set of 4)  
Casters and stoppers attachable (sold separately)  
Polypropylene (uncoloured)  
\* Maximum stacking height is 120 cm.  
\* Total withstand load: (without casters) approx. 39 kg  
(with casters) approx. 19.5 kg when combined with rack that has been placed upside down

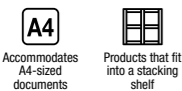

Accommodates A4-sized documents  
Products that fit into a stacking shelf

\* To ensure safety, please follow the stacking limit and withstand load requirements.  
\* The polypropylene cases have slight differences in size due to the characteristics of the material. When stacked, each case may differ slightly in height.

Polypropylene Sturdy Storage Box



Polypropylene Sturdy Storage Box

<b>37525986</b> M	<b>\$29.00</b>	<b>61050652</b> S	<b>\$19.00</b>
Approx. W 60.5 x D 39 x H 37 cm Withstand load: (Lid) approx. 100 kg (Storage) approx. 13.5 kg Stacking limit: 3 units		Approx. W 40.5 x D 39 x H 37 cm Withstand load: (Lid) approx. 100 kg (Storage) approx. 13.5 kg Stacking limit: 3 units	

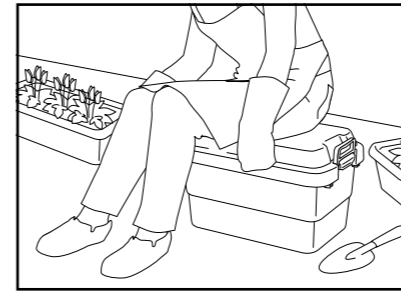

Use as a chair during gardening or other outdoor activities.

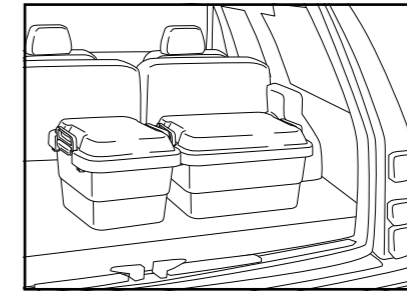

Organise your boot--these storage boxes are robustly designed to withstand vehicle vibrations.



Usage example

## Buri Storage Units

Hand-woven using high quality uncoated, unbleached buri from the Philippines that keeps its natural texture. Some of these highly functional storage baskets also come with lids and handles.



Stackable Buri Basket / Rectangular

**18014002** L **\$26.00**  
Approx. W 37 x D 26 x H 24 cm



**47027914** M **\$19.00**  
Approx. W 37 x D 26 x H 16 cm



**47027907** S **\$16.00**  
Approx. W 37 x D 26 x H 12 cm



Stackable Buri Box / Rectangular

**47027921** **\$13.00**  
Approx. W 26 x D 18.5 x H 12 cm



Stackable Buri Box / Rectangular / Lid

**18014033** **\$5.30**  
Approx. W 26 x D 18.5 x H 2 cm

Stackable Buri Basket / Rectangular / Lid

**18014026** **\$6.90**  
Approx. W 37 x D 26 x H 2 cm

\* This lid can be used with S, M, and L buri baskets.



Buri Square Basket

**47027945** XL **\$36.00**  
Approx. W 35 x D 37 x H 32 cm



Stackable Buri Basket / Square

**18013999** L **\$33.00**  
Approx. W 35 x D 37 x H 24 cm



Stackable Buri Basket / Square / Lid

**18014019** **\$9.30**  
Approx. W 35 x D 37 x H 2 cm

\* This lid can be used with M, L, and XL buri baskets.

### Storage item module dimensions of 37 cm and 26 cm

MUJI's standard module dimensions are derived from the sizes of Japanese homes. These storage items are designed using the standard module dimensions so that they can fit neatly in storage furniture. See P40 for a more detailed description of modules.

#### Compatible storage items



These modules fit in a unit shelf or stacking shelf.

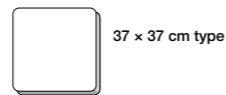

These modules fit in a unit shelf.

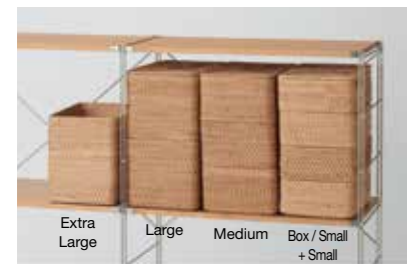

37 x 26 cm baskets arranged

\* Size varies depending on the material.

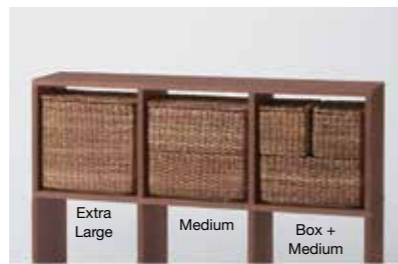

37 x 26 cm baskets arranged



Arrangement of 37 x 37 cm

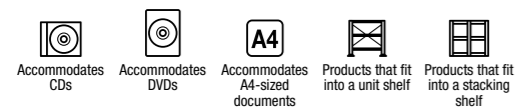

\* Care instructions for natural-material storage products: Do not use these products in humid places. Periodically dry the products in a shade, and remove dust from the surfaces using a vacuum cleaner or a duster.

## Rattan Storage Units

Rattan storage is light and easy to handle, as well as smooth to the touch. These stackable storage items are designed for ease of use, with convenient lids and handles.



Stackable Rattan Basket / Rectangular

**38309819** XL **\$76.00**  
Approx. W 36 x D 26 x H 31 cm

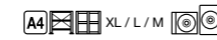

**47381313** L **\$49.00**  
Approx. W 36 x D 26 x H 24 cm



**47381306** M **\$39.00**  
Approx. W 36 x D 26 x H 16 cm



**47381290** S **\$33.00**  
Approx. W 36 x D 26 x H 12 cm

Stackable Rattan Basket / Rectangular / Lid

**15004768** **\$16.00**  
Approx. W 36 x D 26 x H 3 cm

\* Can be used with XL / L / M / or S.



Stackable Rattan Box / With Lid / Rectangular

**47381337** **\$36.00**  
Approx. W 26 x D 18 x H 16 cm



Stackable Rattan Box / Rectangular

**47381238** S **\$33.00**  
Approx. W 26 x D 18 x H 12 cm



Stackable Rattan Box / Rectangular

**37525702** SS **\$16.00**  
Approx. W 26 x D 9 x H 6 cm



Perfect size for organising small objects.



Stackable Rattan Basket / Square

**18021826** L **\$79.00**  
Approx. W 35 x D 36 x H 24 cm



Stackable Rattan Basket / Square / Lid

**18021833** M **\$56.00**  
Approx. W 35 x D 36 x H 16 cm

**15004775** **\$19.00**  
Approx. W 35 x D 36 x H 3 cm

\* Can be used with L or M.



Stackable Rattan Box / With Handle

**47028454** **\$23.00**  
Approx. W 15 x D 22 x H 9 cm



### Country of origin of Rattan Basket

Rattan baskets sold by MUJI are made in Thai Binh province, northern Vietnam. Thai Binh province is a peaceful place with ricefields and free-range cows, buffalos, pigs, and chickens. In addition to farming, the area is also famous for its handicrafts, particularly items of woven rattan and bamboo.



### Making a rattan basket

The rattan, about 3-5 cm in diameter, must first be split into 5-9 mm strips before it can be used to make a basket. The rattan baskets are woven by hand, by farmers. Around 10,000 farmers live in Thai Binh province, it's a way to earn extra income to weave rattan during off-season. This rattan basket takes a long time to weave, only 1-2 can be made in a day.

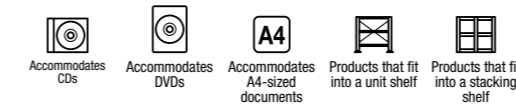

\* Care instructions for natural material storage products: Do not use these products in humid places. Periodically dry the products in a shade, and remove dust from the surfaces using a vacuum cleaner or a duster.

## Bac Bac and Storage Units

The bac bac storage cases use carefully woven handmade ropes made from bac bac (Manila hemp) barks. Boxes made with bamboo's natural features are sturdy and stackable as it barely has size increments. It's easier to handle as they are now stackable.



Stackable Bac Bac Basket / Rectangular

**37525900** XL **\$59.00**  
Approx. W 36 x D 26 x H 32 cm



**37849112** L **\$49.00**  
Approx. W 36 x D 26 x H 24 cm



**37525863** M **\$39.00**  
Approx. W 36 x D 26 x H 16 cm



**37849068** S **\$36.00**  
Approx. W 36 x D 26 x H 12 cm

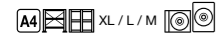

Stackable Bac Bac Basket / Rectangular / Lid

**38309796** **\$16.00**

Approx. W 36 x D 26 x H 2 cm

\* This lid can be used with XL, L, M, and S Bac Bac Baskets.



Stackable Bac Bac Box / Rectangular

**37525948** **\$26.00**  
Approx. W 26 x D 18 x H 16 cm



Stackable Bac Bac Box / Rectangular / Lid

**38309802** **\$13.00**  
Approx. W 26 x D 18 x H 2 cm



Stackable Bac Bac Basket / Square

**37525788** XL **\$69.00**  
Approx. W 35 x D 35 x H 32 cm



**37525825** M **\$49.00**  
Approx. W 35 x D 35 x H 16 cm

Stackable Bac Bac Basket / Square / Lid

**38309789** **\$19.00**

Approx. W 35 x D 35 x H 2 cm

\* This lid can be used with XL and M Bac Bac Baskets.

## Cotton Linen Polyester Storage Units

Coated on the inside, these fabric boxes can be folded compactly. The boxes are made based on MUJI's original size standard, which allow them to be combined with shelves and other items.



Cotton Linen Polyester Soft Box / Rectangular

**38369738** L **\$19.90**  
Approx. W 37 x D 26 x H 34 cm

Perfect size to use as a drawer in stackable shelves.

[Non-washable]



**38369769** M With lid **\$20.90**  
Approx. W 37 x D 26 x H 26 cm

The lid keeps the contents inside.



**38369776** M **\$16.90**  
Approx. W 37 x D 26 x H 26 cm



**38369752** S **\$13.90**  
Approx. W 37 x D 26 x H 16 cm

The coated inside allows to store laundry detergent, clothes pins, and other laundry items.



Cotton Linen Polyester Soft Box

**38369721** L / With lid **\$27.90**  
Approx. W 35 x D 35 x H 32 cm

[Non-washable]



**38369714** L **\$20.90**  
Approx. W 35 x D 35 x H 32 cm



Cotton Linen Polyester Soft / Box Square

**38369691** S With lid **\$20.90**  
Approx. W 35 x D 35 x H 16 cm

Convenient for organising kids' toys. It comes with a lid to keep the dust away.

[Non-washable]



**38369684** S **\$16.90**  
Approx. W 35 x D 35 x H 16 cm

Convenient for organising kids' toys. The boxes can be folded for storage when not in use.



Cotton Linen Polyester Soft Box / Clothes Case

**38369707** L **\$36.00**  
Approx. W 59 x D 39 x H 23 cm

Perfect size to fit comfortably under a bed such as in the unused space under Storage Bed or Bed With Legs with 26 cm-type legs attached.

[Non-washable]



**38369745** S **\$27.90**  
Approx. W 59 x D 39 x H 18 cm

Perfect height that fits underneath a bed. These cases fit comfortably under Bed With Legs with 20 cm-type legs attached.



Cotton Linen Polyester Soft Box / Rectangular

**38369677** S Half **\$10.90**  
Approx. W 18.5 x D 26 x H 16 cm

Convenient for keeping face towels. The boxes can be folded for storage when not in use.

[Non-washable]



Cotton Linen Polyester Soft Box

**38369660** Shallow Half **\$9.90**  
Approx. W 13 x D 37 x H 12 cm

Perfect size for organising neckties, socks, and handkerchiefs.

[Non-washable]



Cotton Linen Polyester Soft Box / Rectangular / S when folded



Usage example of Cotton Linen Polyester Soft Box / Clothes Case / S

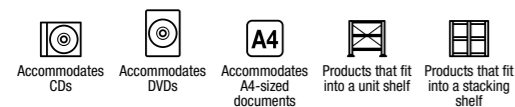

\* Maintaining your natural fibre storage item: avoid using in humid environments. Dry in the shade regularly, and use a vacuum cleaner or duster to clean the surface.  
\* About bamboo: The material used for bamboo storage products have dark shades and nodes that give them an individual unique appearance.

## Hard Pulp Box Steel Tool Box

Storage units that use fibre boards, which are commonly used in industrial pallets and boxes for transportation. Made from 45 to 50% recycled paper, the thickness is achieved by not using glue.

Steel Tool Boxes are useful for various purposes and nicely blend into your room.



**Hard Pulp Box / Drawer Deep**  
**15967162** \$33.00  
 Approx. W 25.5 x D 36 x H 16 cm (with anti-slip pad)  
 Inside dimensions:  
 approx. W 23 x D 34 x H 14 cm  
 Withstand load: 2 kg  
 Stacking limit: 3 units

The size of this item is based on the same size-standard as the Unit Shelf.



**Hard Pulp Box / Drawer 2 Rows**  
**15967179** \$43.00  
 Approx. W 25.5 x D 36 x H 16 cm (with anti-slip pad)  
 Inside dimensions:  
 approx. W 23 x D 34 x H 6.5 cm  
 Withstand load: 1.5 kg  
 Stacking limit: 3 units

The size of this item is based on the same size-standard as the Unit Shelf.



**Hard Pulp Box / Drawer 2 Rows**  
**15967087** \$59.00  
 Approx. W 36 x D 25.5 x H 16 cm (with anti-slip pad)  
 Inside dimensions:  
 approx. W 34 x D 24 x H 6.5 cm  
 Withstand load: 1.5 kg  
 Stacking limit: 2 units

Stores everything from documents to stationery. The size of this item is based on the same size-standard as the Stacking Shelf.



**Hard Pulp Box / Drawer 4 Rows**  
**15967223** \$63.00  
 Approx. W 36 x D 25.5 x H 16 cm (with anti-slip pad)  
 Inside dimensions:  
 approx. W 16 x D 24 x H 6.5 cm  
 Withstand load: 2 kg  
 Stacking limit: 2 units

A box with small compartments. This drawer unit with smaller drawers has the perfect depth for organising letters, bills, and envelopes.



**Hard Pulp Box / With Lid / Stocker**  
**15967209** \$59.00  
 Approx. W 38 x D 36 x H 36 cm  
 Inside dimensions:  
 approx. W 35.5 x D 33 x H 31 cm  
 Withstand load: 10 kg

\* Casters cannot be removed.



**Hard Pulp Box / With Lid**  
**15967193** \$36.00  
 Approx. W 25.5 x D 36 x H 32 cm  
 Inside dimensions:  
 approx. W 23 x D 33.5 x H 31 cm  
 Withstand load: 8 kg  
 Stacking limit: 2 units

The size of this item is based on the same size-standard as the Unit Shelf.

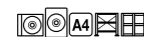

**Steel Tool Box / 4**  
**37845992** \$39.00  
 Approx. W 38 x D 18 x H 13 cm  
 Withstand load: 10 kg



**Steel Tool Box / 3**  
**37845947** \$49.00  
 Approx. W 38 x D 23 x H 10 cm  
 Withstand load: approx. 10 kg  
 Stacking limit: 2 units



**Steel Tool Box / 2**  
**37845886** \$18.60  
 Approx. W 16 x D 11 x H 6 cm  
 Withstand load: approx. 1.5 kg  
 Stacking limit: 3 units



**Steel Tool Box / 1**  
**37845831** \$20.90  
 Approx. W 20 x D 11 x H 6 cm  
 Withstand load: approx. 1.5 kg  
 Stacking limit: 3 units



## Stainless Steel and Tin Storage Units

MUJI's wire baskets make good use of sturdy stainless-steel. Not only do the handles make them easy to carry around, but the handles can be folded inside when stacking the baskets.

The simple tin boxes are easy to use and perfect for keeping commodity

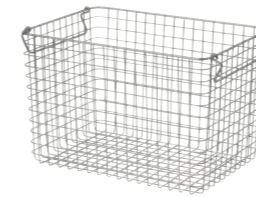

**18-8 Stainless Steel Wire Basket**

**15117079** 5 \$49.00  
 Approx. W 37 x D 26 x H 24 cm  
 Withstand load: 10 kg  
 Stacking limit: 2 units



**15117062** 4 \$43.00  
 Approx. W 37 x D 26 x H 18 cm  
 Withstand load: 5 kg  
 Stacking limit: 2 units



**15117055** 3 \$39.00  
 Approx. W 37 x D 26 x H 12 cm  
 Withstand load: 5 kg  
 Stacking limit: 2 units



**15117048** 2 \$33.00  
 Approx. W 37 x D 26 x H 8 cm  
 Withstand load: 5 kg  
 Stacking limit: 2 units

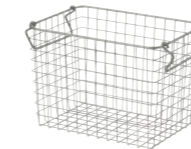

**18-8 Stainless Steel Wire Basket**

**15117031** 1 \$29.00  
 Approx. W 26 x D 18 x H 18 cm  
 Withstand load: 5 kg  
 Stacking limit: 2 units



This basket is made of stainless steel. Baskets can be stacked when the handles are folded inside.



**Tin Box With Lid**

**61417691** L \$33.00  
 Approx. W 25.5 x D 36 (including handles) x H 21 cm



**61417707** S \$26.00  
 Approx. W 20 x D 29 (including handles) x H 15 cm

Boxes for storing various small items made of tin.

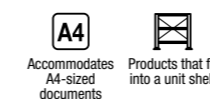

## MDF Storage and File Boxes

MUJI offers useful desktop storage units made from MDF as well as polypropylene boxes for organising A4-sized documents. Select from a variety of types to suit your purposes.



**MDF Storage Stand**  
**61798066** A5 **\$26.00**  
 Approx. W 8.4 x D 17 x H 25.2 cm  
 By using ash on the surface, the storage stand blends into any interior design. Perfect size to place on a desk for organising documents.



**MDF Drawer Unit**  
**76617969** 6 tier **\$59.00**  
 Approx. W 8.4 x D 17 x H 25.2 cm  
**76617952** 3 tier **\$49.00**  
 Approx. W 8.4 x D 17 x H 25.2 cm  
 By using ash on the surface, the drawer unit blends into any interior design. Drawers can be replaced so that the frame can be used vertically or horizontally.



**MDF Single Drawer Unit**  
**76617945** **\$39.00**  
 Approx. W 25.2 x D 17 x H 8.4 cm  
 Useful size for organising desktop items. One partition is provided to separate the inside into compartments.



**MDF Organiser Box**  
**76316510** A4, 2 slots **\$39.00**  
 Approx. W 32 x D 24 x H 10.5 cm  
 An organiser tray which accommodates A4-sized paper. This partition stand is useful for organising and sorting postcards, envelopes, and documents.  
 \* Stacking limit: 3 units



**Cardboard File Box Set**  
**15095094** A4 / 5 pieces **\$12.90**  
 Approx. W 10 x D 31.6 x H 24.6 cm



**Cardboard Stand File Box**  
**15095087** A4 / 5 pieces **\$12.90**  
 Approx. W 10 x D 27.6 x H 31.8 cm



**Polypropylene Carry Box / Wide**  
**15915453** White grey Each **\$13.90**  
**37035508** White grey Each **\$13.90**  
 Approx. W 15 x D 32 x H 8 cm  
 Withstand load: approx. 5 kg  
 Useful carry box for organising and carrying around tools and stationery.  
 \*2



**Polypropylene Box**  
**61154909** A4 / 6 drawers **\$36.00**  
**61164458** A4 / 3 drawers **\$29.00**  
 Approx. W 11 x D 24.5 x H 32 cm  
 The drawers are suitable for storing all sorts of items. The height is the same as that of file boxes, so they can be easily placed on a bookshelf. Drawers can be replaced so that the frame can be used vertically or horizontally.  





**Polypropylene File Box / Wide**  
**76475965** A4 **\$13.90**  
**76475972** A4 / White grey **\$13.90**  
 Each **\$13.90**  
 Approx. W 15 x D 32 x H 24 cm  
 This wide type file box can store up to two 50 mm wide double-hole files.  





**Polypropylene Stand File Box / Wide**  
**61796895** A4 **\$13.90**  
**61796895** A4 / White grey **\$13.90**  
 Each **\$13.90**  
 Approx. W 15 x D 27.6 x H 31.8 cm  
 This wide type file box can store up to two 50 mm wide double-hole files.  



**Polypropylene File Box**  
**15734528** A4 **\$11.30**  
**15556366** A4 / White grey Each **\$11.30**  
 Approx. W 10 x D 32 x H 24 cm  
 Made of thick, solid plastic. This file box can also stand on its side.  



**Polypropylene Stand File Box**  
**15318476** A4 **\$9.60**  
**15790821** A4 / White grey Each **\$11.30**  
 Approx. W 10 x D 27.6 x H 31.8 cm  
**37035669** Half **\$9.60**  
 Approx. W 5 x D 27.4 x H 31.8 cm  

 Accommodates A4-sized documents  
 Products that fit into a unit shelf  
 Products that fit into a stacking shelf

\*1 Do not use in any environment with high temperatures or humidity or in direct sunlight. Failure to avoid these environments can lead to deformation or discolouration.  
 \*2 Although identical products can be stacked, be careful of stacking too many units. (Up to 3 units is recommended) This item can also be stacked on the "Polypropylene File Box / Wide." As it cannot be secured, please be careful when using it stacked.

## Acrylic Storage Units

Acrylic storage units feature scratch resistance as well as transparency that allows you to identify the contents from the outside. MUJI offers a rich variety of acrylic storage units suitable for any purpose or space, such as on your desktop or in your living room.



**Acrylic Case / 5 Rows**  
**15873128** Large **\$46.00**  
 Approx. W 25.5 x D 17 x H 16 cm  
 The transparent material lets you easily identify the contents from the outside. This useful storage case can serve a variety of purposes.



**Acrylic Case / 3 Rows**  
**61485546** Large **\$33.00**  
 Approx. W 25.5 x D 17 x H 10 cm  
 The transparent material lets you easily identify the contents from the outside. This useful storage case can serve a variety of purposes.



**Acrylic Case With Drawer / 2 Rows**  
 1 **47380934** Large **\$39.00**  
 Approx. W 25.5 x D 17 x H 9.5 cm  
 2 **47380910** **\$23.00**  
 Approx. W 17.5 x D 13 x H 9.5 cm  
 \*1



**Acrylic Case With Lid / 2 Rows**  
**47380989** Large **\$39.00**  
 Approx. W 25.5 x D 17 x H 9.5 cm  
 2 **47380965** **\$23.00**  
 Approx. W 17.5 x D 13 x H 9.5 cm  
 \*1



**Acrylic Case / Velour Partition**  
**38373568** Large / Grey **\$16.00**  
 Approx. W 23.5 x D 15.5 x H 2.5 cm  
 Organiser tray that fits into the Acrylic Case for keeping accessories and watches. One tray fits into the large drawer type.



Usage example



**Acrylic Case / Velour Partition For Rings**  
**38373551** Large / Grey **\$16.00**  
 Approx. W 23.5 x D 15.5 x H 2.5 cm  
 Organiser tray that fits into the Acrylic Case for keeping accessories and watches. One tray fits into the large drawer type.



Usage example



**Acrylic Case / Velour Inner Box**  
**38373575** Grey **\$9.90**  
 Approx. W 15.5 x D 12 x H 2.5 cm  
 Organiser tray that fits into the Acrylic Case for keeping accessories and watches. Two trays fit into the large drawer type.



Usage example



**Acrylic Case / Velour Grid Partition**  
**38373544** Grey **\$16.00**  
 Approx. W 15.5 x D 12 x H 2.5 cm  
 Organiser tray that fits into the Acrylic Case for keeping jewellery. Two trays fit into the large drawer type.



Usage example



\*1 Older models can be stacked on the new model, but placing a new model on an older model may create gaps or cause the units to shift. The partitions for new drawer type products are not supported to fit into older models.



**Acrylic Storage Box**

1 **38907589** 3 drawers, A4 **\$49.00**  
 Approx. W 11 x D 24 x H 32 cm

2 **38907572** 6 drawers, A4 **\$59.00**  
 Approx. W 11 x D 24 x H 32 cm

By reconfiguring the boards, this storage box can be used either vertically or horizontally.



Horizontal placement



**Acrylic Stand For Eye Glasses**

**61174280** **\$39.00**  
 Approx. W 6.7 x D 17.5 x H 25 cm

Store glasses and accessories in the 4 drawers. This stand vertically or horizontally.



**Acrylic Stand / Velour Inner Box For Eye Glass**

**38373520** Grey **\$9.90**  
 Approx. W 5 x D 16.5 x H 2 cm

This organiser tray is only for the Acrylic Stand For



Usage example



**Acrylic Drawer Unit**

3 **61798202** 3 drawers **\$39.00**  
 Approx. W 8.7 x D 17 x H 25.2 cm

4 **37268142** 6 drawers **\$49.00**  
 Approx. W 8.7 x D 17 x H 25.2 cm

Made with clear acrylic resin for easy identification of contents. Looks neat and organised when used aligned with other acrylic storage units with the same height.



**Acrylic Stand For Pierced Earrings And Necklace**

**18958207** **\$23.00**  
 Approx. W 6.7 x D 13 x H 25 cm

This see-through stand keeps necklaces and earrings.



**Acrylic Stand / Velour Partition For Rings**

**38373537** Grey **\$9.90**  
 Approx. W 5 x D 12 x H 2 cm

This organiser tray for holding rings only fits into the Acrylic Stand For Pierced Earrings And Necklace.



Usage example



**Acrylic Single Drawer Unit**

**61798196** **\$29.00**  
 Approx. W 25.2 x D 17 x H 8.7 cm

Convenient for keeping small miscellaneous items. Made with clear acrylic resin for easy identification of



**Acrylic Storage Stand**

**61798233** A5 **\$23.00**  
 Approx. W 8.7 x D 17 x H 25.2 cm

This desktop stand is useful for organising A5-size documents, notebooks, and catalogues.



**Acrylic Divider**

1 **15902194** 3 dividers **\$23.00**  
 Approx. W 26.8 x D 21 x H 16 cm

2 **15902200** 3 dividers **\$19.00**  
 Approx. W 13.3 x D 21 x H 16 cm

This partition stand is useful for organising and sorting books, magazines, and documents.



**Acrylic Stand**

3 **15296248** **\$16.00**  
 Approx. W 13 x D 8.8 x H 9.5 cm

4 **15296231** **\$11.90**  
 Approx. W 8.8 x D 8.8 x H 9.5 cm



**Acrylic Pen Stand**

**61479798** **\$2.90**  
 Approx. W 5.5 x D 4.5 x H 9 cm



**Acrylic Stand For Letters**

**15296224** **\$9.00**  
 Approx. W 5 x D 13 x H 14.1 cm

Desktop letter stand for storing envelopes and postcards.

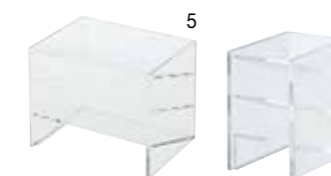

**Acrylic Rack**

5 **15296309** **\$29.00**  
 Approx. W 17.5 x D 13 x H 14.3 cm

6 **15296286** **\$19.00**  
 Approx. W 8.8 x D 13 x H 14.3 cm



**Acrylic Deep Case**

**61407876** **\$23.00**  
 Approx. W 17.5 x D 13 x H 9.5 cm

This acrylic case with a drawer is stackable. It is convenient for storing small items such as cosmetic products.

\* Stacking limit: 2 units  
 \*1



**Acrylic Postcard Box**

**76517863** Postcard size **\$16.00**  
 Approx. W 16.3 x D 11.6 x H 5 cm

This photo / postcard box can be used to organise and store photos and postcards. A photo or a postcard can be inserted into the lid, which makes it not only a useful organiser, but also usable as a stand.



\*1 Older models can be stacked on the new model, but placing a new model on an older model may create gaps or cause the units to shift. The partitions for new drawer type products are not supported to fit into older models.

# ABS Resin Trays

MUJI trays help keep your desk organised by storing documents and stationery, as well as miscellaneous small items. Trays in the same series can be used in combination with each other.



**Acrylic Pot**  
 1 **61479781** with lid **\$5.90**  
 Approx. dia. 8 x H 11.5 cm  
 2 **61485584** **\$4.90**  
 Approx. dia. 8 x H 11 cm



**Acrylic Stackable Stand With Partition / Half**  
 3 **61407852** **\$13.90**  
 Approx. W 17.5 x D 6.5 x H 9.5 cm  
 4 **61407869** **\$9.90**  
 Approx. W 17.5 x D 6.5 x H 4.8 cm  
 This acrylic stand is stackable. It is convenient for storing small items such as cosmetic products.  
 \* Stacking limit: 2 units



**Acrylic Stackable Stand With Partition**  
**61407838** **\$19.00**  
 Approx. W 17.5 x D 13 x H 9.5 cm  
 \* Stacking limit: 2 units



**Acrylic Stackable Box With Partition**  
**61407845** **\$29.00**  
 Approx. W 25.8 x D 17.5 x H 6.1 cm  
 This acrylic case is stackable. It is convenient for storing small items such as cosmetic products. The partitions can be removed.  
 \* Stacking limit: 2 units



**Acrylic Stackable CD Box**  
**76226277** **\$23.00**  
 Approx. W 13.5 x D 27 x H 15.5 cm  
 This box can store up to approximately 25 CDs.



**Acrylic Stackable CD Rack**  
**76226253** **\$19.00**  
 Approx. W 17.5 x D 13 x H 14 cm  
 This rack can store up to approximately 16 CDs.  
 \* Stacking limit: 2 units



**Acrylic Collection Box**  
**61703671** 4 x 4 compartments **\$49.00**  
 Approx. W 27.5 x D 7.2 x H 34.7 cm  
 Non-transparent back plate is used to accentuate the collection. Items can be placed or taken out from the front or back.



**Acrylic Bottle Stand**  
 5 **87317895** 2 compartments **\$23.00**  
 6 **87318533** 3 compartments **\$23.00**  
 Approx. W 17.5 x D 6.5 x H 23 cm  
 This bottle stand is useful for organising small jars and bottles.  
 \* Do not store oil-based solutions, such as essential oils and body oils, in this stand.



**Acrylic Partition Shelf**  
 7 **15919840** **\$13.90**  
 Approx. W 26 x D 17.5 x H 16 cm  
 8 **15919833** **\$11.90**  
 Approx. W 26 x D 17.5 x H 10 cm



**Acrylic Tissue Box**  
**76226284** **\$12.90**  
 Approx. W 26 x D 13 x H 7 cm



**Acrylic Table Top Tissue Box**  
**88395836** Comes with tissue **\$9.90**  
 Approx. W 14 x D 11.5 x H 7 cm  
 Paper tissues can be stored in this small and compact box.



**Paper Tissue**  
**88395829** Number of sheets:  
 300 (150 two-ply sheets) x 3 **\$5.90**  
 Packaged in plastic to conserve packaging materials. The width of the item is thinner than common tissue paper and can be used in the Acrylic Table Top Tissue Box.



Usage example

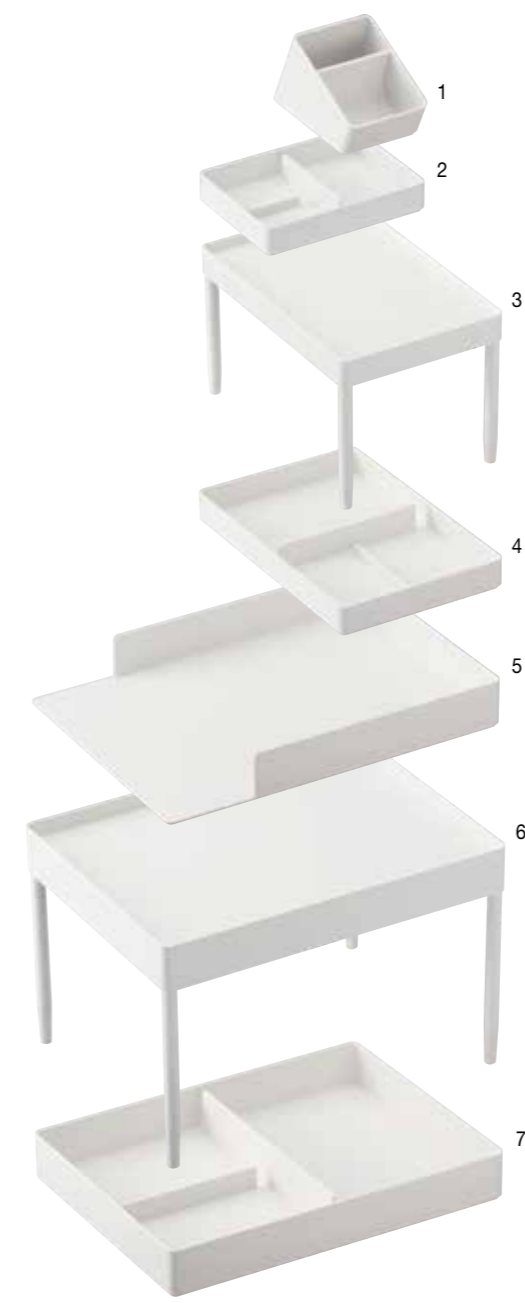

**ABS Stand 1/8**  
 1 **87328938** Approx. W 8.1 x D 11 cm **\$11.30**  
 Outside dimensions: approx. W 8 x D 11 x H 8 cm  
 Inside dimensions, Top: approx. W 7.4 x H 8.2 cm  
 Bottom: approx. W 7.4 x H 4.8 cm  
 The inside of this stand is divided into separate compartments for writing utensils and small office items.

**ABS Tray 1/4**  
 2 **87328891** A6 **\$11.30**  
 Outside dimensions: approx. W 12 x D 16 x H 2.9 cm  
 Inside dimensions: approx. W 11.5 x D 15.5 x H 2.6 cm  
 Stacking limit: 3 units  
 Total withstand load: 1.5 kg  
 The inside of this tray is divided into separate compartments.

**ABS Tray With Legs 1/2**  
 3 **87328945** A5 size, with 4 legs **\$16.00**  
 Outside dimensions with legs attached: approx. W 16 x D 24 x H 14.7 cm  
 Tray portion: approx. H 2.6 cm  
 Inside dimensions: approx. W 15.5 x D 23.5 x H 1 cm  
 Stacking limit: 2 units  
 Total withstand load: 1.5 kg  
 This tray can be used as a shelf by attaching the legs included.

**ABS Tray 1/2**  
 4 **87328617** A5 **\$13.00**  
 Outside dimensions: approx. W 16 x D 24 x H 2.9 cm  
 Inside dimensions: approx. W 15.5 x D 23.5 x H 2.6 cm  
 Stacking limit: 3 units  
 Total withstand load: 3 kg  
 The inside of this tray is divided into separate compartments.

**ABS Filing Tray**  
 5 **87328594** A4 **\$19.00**  
 Outside dimensions: approx. W 24 x D 32 x H 4.5 cm  
 Inside dimensions: approx. W 23.5 x D 31.5 x H 4.2 cm  
 Stacking limit: 3 units  
 Total withstand load: 9 kg  
 This tray is useful for keeping documents organised.

**ABS Tray With Legs**  
 6 **87328587** A4 **\$23.00**  
 Outside dimensions with legs attached: approx. W 24 x D 32 x H 20.8 cm  
 Tray portion: approx. H 4.2 cm  
 Inside dimensions: approx. 23.5 x D 31.5 x H 1.5 cm  
 Stacking limit: 2 units  
 Total withstand load: 4.5 kg  
 This tray can be used as a shelf by attaching the legs included.

**ABS Tray**  
 7 **87328600** A4 **\$19.00**  
 Outside dimensions: approx. W 24 x D 32 x H 4.5 cm

\* Do not allow the resin material to come in contact with chemicals such as alcohol, oil, thinner, polish remover, strong acid, or strong alkali, as they may cause discolouration or deformation.  
 \* To prevent scratches when cleaning, avoid using cleansers, abrasive powder, or hard materials such as scouring pads.  
 \* Due to the characteristics of the material, stains or smudges may be visible on the surface.  
 \* To clean the resin material, gently wipe with a soft cloth soaked in a neutral detergent diluted with 50% water.  
 \* Do not use an acidic detergent for cleaning. Doing so may result in deformation.

## The items in this series are perfect for keeping your desk tidy.

These items can be stacked or used in combination with each other, enabling you to make more efficient use of the space on your desk. For smaller items, you can use trays that are divided into separate compartments, or you can attach legs to trays and use them as small shelves. These products are convenient when you do not have a lot to store, but want a place to put a few items.



Conveniently to store pens and various desk items.



Stack three trays for A4 size documents to keep your magazines, catalogues, and documents organised.



Trays with legs make efficient use of space and keep small, miscellaneous items organised.





Stainless Steel Unit Shelf P8

## Good enough Living Column vol.1

### Storage Furniture & Storage Units

#### Quality in modest simplicity

Spaces inside Japanese homes are said to have developed around the dimensions of the standard tatami mat, which measures 180 cm by 90 cm. Tatami mats then determined the standard dimensions for the *fusuma* sliding doors that divide Japanese rooms. Even now with the Japanese homes rapidly westernising since the mid 1940s, these standard dimensions are still the norm today. It is this traditional concept that informs the designs behind MUJI storage furniture. Take the size of our Stainless Steel Unit Shelf / Wide / Large, for example, which is the standard for the series. The 175.5 cm by 86 cm shelves are approximately the same size as the standard tatami mat and *fusuma* door. This is a perfect storage unit for smaller rooms, while several units side-by-side create a unified, streamlined look in larger rooms. In addition to the 175.5 cm unit, we also offer 120 cm and 83 cm stainless steel shelves.

All models are available in both 86 cm and 58 cm width versions. At 41 cm deep, these shelves hold stacks of books. Our unit shelves hold storage boxes and baskets made from natural materials, as well as polypropylene, all designed to uniform dimensions to line up neatly for a clean, uncluttered look. Storage furniture should be adaptable and expandable for long years of use. MUJI storage units are designed so that customers can create and recreate the sizes and shapes that work best with their own particular space. Designed to make the most of the colour and natural qualities of the materials, creating a naturally beautiful backdrop to your days, MUJI storage holds its own no matter what the trends are. This is lasting quality born of modest simplicity.

“Storage built on the practical wisdom of tatami and *fusuma* design.”



## Sleep, wrapped in comfort.

Going to bed with the sun and waking at sunrise is conventional wisdom passed down through the ages. Our lifestyle has changed dramatically over time, but sleep is the one thing that has not changed. A proper night's sleep is still essential to staying physically and mentally healthy. How about coordinating your bed and the space around it with what makes you most comfortable and relaxed? MUJI offers a line of beds designed to create your ideal space, with an array of options to suit your space and style. Choose classic bedding items in subtle colours made from cotton, linen, and other natural materials that feel good against the skin. Change the fabric and colour of your bedding to suit the season for an even more comfortable night's sleep. You want to make this space the most comfortable in your home. MUJI's extensive line of beds, bedding, and bedroom accessories are designed to create your very own space for a perfect sleep.

## BEDS

## Beds



**Bed Frame** ..... 70

Choose your own combination for a bed that suits your lifestyle and taste.



**Mattress With Legs** ..... 74

Simple bed consisted in just a mattress and legs. It features a great sleeping comfort and durable frame.



**Mattresses** ..... 78

Designed with a focus on the core structure of the mattress. Choose from the wide selection of comfort that works best for you.



**Bed Pads** ..... 81

Top a mattress or futon with our machine washable bed pads to maintain the bed clean.



**Oak Bed** ..... 75

Enjoy the beautiful natural wood grain pattern of an oak bed in a simple design that never grows old.



**Storage Bed** ..... 76

Put an empty space to use with a bed with plenty of storage space below.

# Bed Frame

The low-profile frames create a subtle bed with a cosy feel. We carefully considered the layout and number of wooden springs, for a great sleeping comfort. Available in oak and walnut.

## Your original bed frame

People wish for uniquely different characteristics in beds, which is natural for equipment that people spend a lot of time on. More storage space, using two single-sizes side-by-side, (a rounded design so it does not hurt when you hit your toes), and a better ventilation, to name a few preferences. MUJI's Bed Frame was born from such customer feedback. The headboard is designed so that two beds can be seamlessly placed next to each other. The bed frame provides space underneath for storage. MUJI developed its new bed for the comfort of users during sleep and in daily life.



### Headboard

The angle of the headboard is adapted to give comfort and relaxation. One way of enjoying a bed is reading before bedtime while leaning against the headboard.

### Mattress

MUJI offers six types of mattresses with different sleeping comfort.

### Wood springs

The wood springs add a cushioning along with the mattress, dispersing the body pressure and reducing the load on the back and hips. This function of the wood springs also extends the life of the mattress. We carefully considered the layout and number of wooden springs, for a great sleeping comfort.

### Legs

The attached legs can be removed to use the bed placed directly on the floor.

### Storage

Adding Bed Frame / Canvas Basket (sold separately), you can most effectively utilise the space under the bed.

\* Example combination: mattress and baskets are sold separately.

### Bed Frame / Oak

38370031	Single	W 103 × D 202 × H 25.5 cm	\$469.00
38370055	Double	W 147 × D 202 × H 25.5 cm	\$629.00
38370062	Queen (Nov)	W 171 × D 202 × H 25.5 cm	\$709.00
38370079	King (Nov)	W 182 × D 202 × H 25.5 cm	\$789.00

### Bed Frame / Walnut

1 38370093	Single	W 103 × D 202 × H 25.5 cm	\$549.00
38370116	Double	W 147 × D 202 × H 25.5 cm	\$709.00
38370123	Queen (Nov)	W 171 × D 202 × H 25.5 cm	\$789.00
38370130	King (Nov)	W 182 × D 202 × H 25.5 cm	\$869.00



- \* Floor to bed frame: 19 cm (when legs are attached / the same for all bed sizes)
- \* Height when placed directly on the floor: 6 cm (including felt).
- \* Please use the supplied felt when using the bed frame without the legs. Periodically stand up the mattress to air and remove humidity.
- \* Please use the mattress dedicated to a bed or Bed Frame / Cushion (Small only).



The legs can be removed to place the bed frame directly on the floor.

\* Example combination: mattress is sold separately.

### Wooden Bed Frame / Headboard / Oak

37285538	Single	W 103 × D 8 × H 53 cm	\$189.00
37285552	Double	W 147 × D 8 × H 53 cm	\$289.00
38918523	Queen (Nov)	W 171 × D 8 × H 53 cm	\$339.00
38371342	King (Nov)	W 182 × D 8 × H 53 cm	\$389.00

### Wooden Bed Frame / Headboard / Walnut

2 37285583	Single	W 103 × D 8 × H 53 cm	\$239.00
37285606	Double	W 147 × D 8 × H 53 cm	\$339.00
38918530	Queen (Nov)	W 171 × D 8 × H 53 cm	\$389.00
38371359	King (Nov)	W 182 × D 8 × H 53 cm	\$439.00

- \* The headboard is 2.5 cm thick. The height is approximately 80 cm when attached to the bed.
- \* The headboard cannot be used when the bed is used without legs.
- \* Due to the use of natural wood, the wood patterns differ with individual products.
- \* Due to the bent structure of the headboard, the angle of the headboard may vary. This can be adjusted by using a supplied spacer.



### A new look at the wooden springs

We carefully considered the layout and number of wooden springs, and increased the number of wood springs and cushioning for more comfort of lower-back.

\* Single, semi-double, double, queen, and king size.

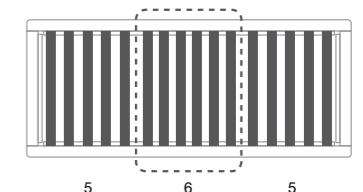

\* The characteristics of natural wood, such as the colour and grain, may vary in appearance depending on the material.  
 \* To ensure the long term use of your bed frame, please use a bed mattress that provides superior body weight distribution. Do not use a futon directly on the bed frame as doing so can cause damage to the frame or cracks in the boards.  
 \* Various mattresses are listed on P112-114, including Ultra High Density Pocketcoil Mattress, High Density Pocketcoil Mattress, Pocketcoil, Bonnell Coil Mattress, and Coil-less Mattress.

## Bed Frame Canvas Basket

Hanging type storage baskets for under Bed Frame. Because the baskets are suspended from rails, the space under the bed is most-effectively used, even when the bed is placed on a rug.



\* Example combination: mattress is sold separately.  
\* The above picture is a single size walnut bed frame.

### Bed Frame / Canvas Basket

1 **38370338** Large **\$79.00**  
Outside dimensions: W 76.5 x D 55 x H 13.5 cm  
Inside dimensions: W 69.5 x D 49.5 x H 12.5 cm  
Withstand load: 7 kg

2 **38370321** Small **\$59.00**  
Outside dimensions: W 76.5 x D 37.5 x H 13.5 cm  
Inside dimensions: W 69.5 x D 34.5 x H 12.5 cm  
Withstand load: 5 kg

### Bed Frame / Basket Rail (2 Sets)

3 **38370277** Single W 2.5 x D 93.5 x H 3 cm **\$79.00**  
**38370291** Double W 2.5 x D 137.5 x H 3.5 cm **\$99.00**  
**38370307** Queen (Nov) W 2.5 x D 157 x H 4 cm **\$99.00**  
**38370314** King (Nov) W 2.5 x D 177 x H 4 cm **\$109.00**

2 sets: for 2 rows of baskets (4 pieces), storage handles included  
Rails for attaching Bed Frame / Canvas Basket.



Storage handle



## Underbed Storage

Storage with casters. The dividers can separate the storage space into smaller spaces for easier storage.

For example, you can separate the things that you use often with the things that you don't.



\* Example combination: mattress is sold separately.  
\* The above picture is a single size oak bed frame.

### Bed Frame / Underbed Storage

4 **37285620** Large / Oak **\$189.00** **37285644** Small / Oak **\$159.00**  
**37285637** Large / Walnut **\$229.00** **37286139** Small / Walnut **\$189.00**

Outside dimensions: W 80 x D 90.5 x H 19 cm  
Inside dimensions: W 76.5 x D 83.5 x H 13.5 cm  
Partitions: 1 large, 4 small

Withstand load: 10 kg

\* A flathead screwdriver is required for assembling the storage case.

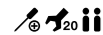

## Attaching the bed frame canvas basket and basket rail

It can be used over rugs as it hangs from a rail. Previously, only the space on the front side under the bed could be used, but now you can use the entire space with the rail, and usable space has been increased.

## It cannot be attached to the old model bed frame.

\* Due to the structure of the old-type bed.

Differences between new and old model

(1) Number of wooden springs

Old: Single 15, Semi-double and double 30

→ New: Single 16, Semi-double and double 32 \*Small is unchanged

(2) Underside of steel frame

Old: No attaching for Bed frame canvas basket → New: Attaching for Bed frame canvas basket for Bed Frame Canvas Baskets

## Example of combination

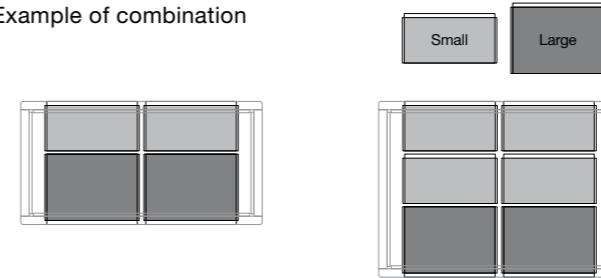

\* The characteristics of natural wood, such as the colour and grain pattern, may vary in appearance depending on the material.

\* To ensure the long term use of your bed frame, please use a bed mattress that provides superior body weight distribution. Do not use a futon directly on the bed frame as doing so can cause damage to the frame or cracks in the boards.

\* The cover may shrink due to dry-cleaning and washing.

## Mattress With Legs (Washable Cover)

This simple bed was born from a meticulous pursuit of sleeping comfort and quality materials. The Pocket Coil Mattress With Legs adopts a full wood spring design while the Bonnell Coil Mattress With Legs features increased coil height for enhanced sleeping comfort.

### Bonnell Coil Mattress With Legs

The interior mattress is covered by nonwoven fabric, which allows you to rotate the mattress or change the parts easily, leading to a longer product life.



\* Combination example with Legs For Mattress With Legs / Brown

### Changeable cover (shell) and coil unit

The legs, steel frame, and coil unit can be separated from each other, and everything is covered by the cover (shell) using hook-and-loop fastener. Each of the parts is individually sold, so you can lower the impact on the environment by changing only worn-out-parts and separating parts for recycling.

\* Steel frames are not sold separately.

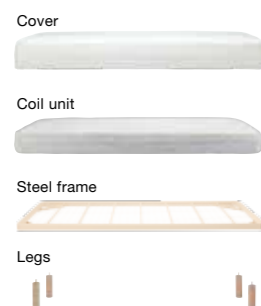

### Rotate the mattress for longer life

Switch the head and feet side every season. The strength of springs may deteriorate if a load is continuously applied to the same point. By changing the mattress orientation and distributing your body weight more evenly over time, you can reduce the load on the springs.

Make sure to periodically air the mattress by standing it up. Moisture may build up inside the mattress if it is always kept on the bed frame, possibly leading to the formation of mould.

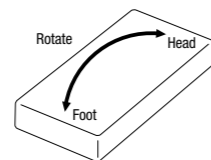

### Well-balanced placement of pocket coil springs

Slightly firmer springs are used in the lower-back area for extra durability. Even firmer springs are used around the edges to support body weight when sitting. Softer springs are used in the wide area that supports the body. The springs with three different levels of firmness are placed appropriately for each function.

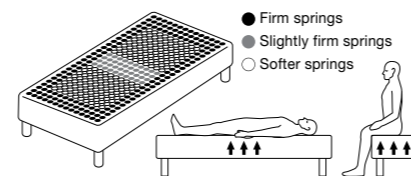

\* Storage boxes cannot be inserted if 12 cm-type legs are used.

### Underbed storage for mattress with legs

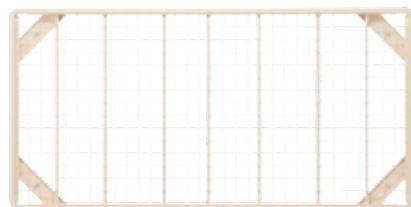
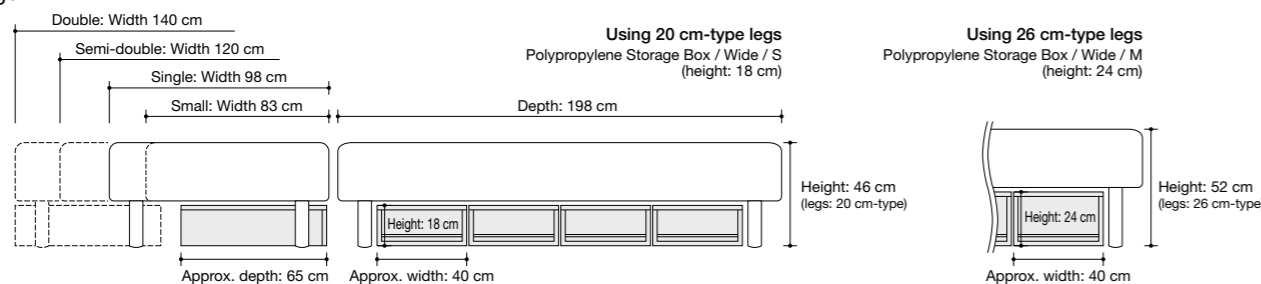

### Bonnell Coil Mattress With Legs / Steel Frame Type

**37497788** Single **\$309.00**

W 98 x D 198 x H 26 cm

\* 12 cm or 20 cm legs can be selected for the price shown under "+ Wooden legs."

[Machine washable (in laundry net)]

Mattress is designed to fit into a steel frame, which provides improved cushioning effect for a better sleeping comfort. The mattress features a perfect firmness for both sitting and sleeping.

\* Use a laundry net when machine-washing the cover. The capacity of washing machine must be at least 8 kg.  
\* The size may vary depending on the individual product.



### Legs For Mattress With Legs / Set of 4

**15296972** H 26 cm / Natural **\$39.00**  
**1 47462203** H 20 cm / Natural **\$33.00**

The addition of the 26 cm-type to the lineup offers a storage space under the bed. MUJI's 24 cm-high polypropylene storage units can fit in under the bed.

\* This product can be used with both Pocket Coil and Bonnell Coil Mattresses.  
\* This product can be used with most older models of Mattress With Legs. Please ask our staff at any MUJI store for details.  
\* The 26 cm-type is compatible with all steel frame sizes. The wooden frame (older model) only supports the Small and Single sizes.

## Oak Bed

MUJI's assembly-type oak beds feature a beautiful wood grain. The basic design never loses its lustre. The frame uses robust laminated lumber.



\* Example combination: mattress and clock are sold separately.

### Oak Bed

**37285248** Single **\$699.00**

W 100 x D 202 x H 74 cm

**37285279** Queen **\$1199.00**

W 160 x D 202 x H 74 cm

**37285286** King **\$1399.00**

W 180 x D 202 x H 74 cm

The headboard is angled to fit your body when you lean against it. The lower part of the head board has a certain depth so it can be used for clocks or other items.



Bed board

### Materials are carefully selected for your long-term use.

The square wood pieces used for the Oak Bed legs are produced by pasting together three 1-inch (approx. 2.5 cm) wood boards that are commonly available to make a square block. This way, resources are economically and efficiently used, which also contributes to the reasonable prices. MUJI's beds, made with durable materials, can be used for a long time.

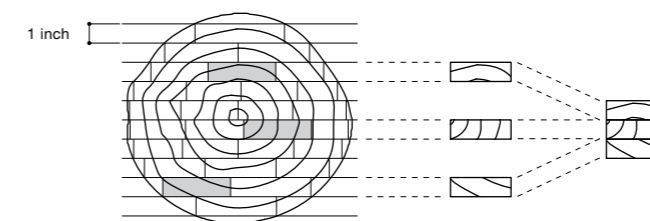

Wood boards are pasted together to make a stronger, square block.

### Also designed to let you sit back and relax.

The upper part of the headboard is angled to support your body when you lean against it, and the lower part is deep enough to hold items such as a clock.



◆ To ensure the long term use of your bed frame, please use a bed mattress that provides superior body weight distribution. (When using a futon mattress on a bed frame, your body weight is applied directly to bed board, which can eventually lead to problems such as cracked bed board.)

\* Due to the use of natural wood, the colour of each product may slightly vary. The colour may also appear differently under different lighting.

\* Due to the nature of the material, oak may have a unique pattern called "tiger grain." \* The characteristics of natural wood, such as the colour and grain pattern, may vary in appearance depending on the material.

# Storage Bed

This single bed features a storage space equal to that of two wide 4-drawer chests. Store everything from daily-use clothing to suitcases and comforters.

## Bed + Storage

MUJI renewed its under-bed storage for a more efficient use of the room. The bed provides a larger storage space by adopting a structural design in which the mattress is supported by the storage boxes themselves.



Bed board is made of wood slats that reduce the dust getting into the storage compartment.

### Storage Bed / Oak

1	<b>37407947</b> Single	<b>\$559.00</b>	<b>38371229</b> Queen	<b>\$879.00</b>
	W 105.5 x D 201 x H 27 cm		W 168.5 x D 201 x H 27 cm	
	<b>37407961</b> Double	<b>\$719.00</b>	<b>38371236</b> King	<b>\$999.00</b>
	W 148.5 x D 201 x H 27 cm		W 188.5 x D 201 x H 27 cm	

### Storage Bed / Walnut

	<b>37407985</b> Single	<b>\$639.00</b>	<b>38371243</b> Queen	<b>\$959.00</b>
	W 105.5 x D 201 x H 27 cm		W 168.5 x D 201 x H 27 cm	
2	<b>37408005</b> Double	<b>\$759.00</b>	<b>38371250</b> King	<b>\$1099.00</b>
	W 148.5 x D 201 x H 27 cm		W 188.5 x D 201 x H 27 cm	

Withstand load of drawer: 10 kg  
 Inside dimensions of drawer: W 85.5 x D 51.5 x H 15.5 cm (common to all sizes)  
 This bed with plenty of storage space can contribute to an efficient use of limited space.

Withstand load of drawer: 10 kg  
 Inside dimensions of drawer: W 85.5 x D 51.5 x H 15.5 cm (common to all sizes)

## Example storage under a Double bed



**Open space**  
 A storage space is also provided behind the drawer space. In the space under Semi-double and Double, you can store long or large objects, such as rugs, skis, comforters, and carry cases.  
 \* Bottom board is not provided under the open space.

**Drawers**  
 In the drawers, available for all sizes of beds, you can store daily-use clothing and beddings.

**Ventilation holes**  
 Base support  
 Ventilation holes are made below the open space to allow moisture to escape.

Inside dimensions of open space:  
 W 189 x H 23.5 cm (small / single / semi-double)  
 W 186 x H 23.5 cm (double)  
 Depth: 21 cm (small) / 38 cm (single) / 61 cm (semi-double) / 81 cm (double)  
 Inside dimensions of drawers: W 85 x D 51 x H 15.5 cm (all sizes)

## Storage Bed Additional Box / Storage Bed Headboard

An additional box allows you to place a 210 cm-long futon on the bed, and a head board with a simple design can be separated from the wall.

3  
 Often-used CD's and paperback books can be stored in the Additional Box. Adding the box allows you to use futon on the bed frame.



\* Example combination: mattress and pillows are sold separately.  
 \* The above picture is a double size walnut storage bed.

### Storage Bed / Additional Box / Oak

	<b>37416659</b> Single	<b>\$149.00</b>		
	W 105.5 x D 15 x H 27 cm			
	<b>37416673</b> Double	<b>\$179.00</b>		
	W 148.5 x D 15 x H 27 cm			
	<b>38371267</b> Queen	<b>\$229.00</b>		
	W 168.5 x D 15 x H 27 cm			
	<b>38371274</b> King	<b>\$259.00</b>		
	W 188.5 x D 15 x H 27 cm			

### Storage Bed / Additional Box / Walnut

	<b>37416925</b> Single	<b>\$169.00</b>		
	W 105.5 x D 15 x H 27 cm			
3	<b>37416949</b> Double	<b>\$199.00</b>		
	W 148.5 x D 15 x H 27 cm			
	<b>38371281</b> Queen	<b>\$249.00</b>		
	W 168.5 x D 15 x H 27 cm			
	<b>38371298</b> King	<b>\$279.00</b>		
	W 188.5 x D 15 x H 27 cm			

### Storage Bed / Headboard / Oak

	<b>37497849</b> Single	<b>\$179.00</b>		
	W 105.5 x D 6 x H 81 cm			
	<b>37497863</b> Double	<b>\$259.00</b>		
	W 148.5 x D 6 x H 81 cm			
	<b>38371304</b> Queen	<b>\$279.00</b>		
	W 168.5 x D 15 x H 27 cm			
	<b>38371311</b> King	<b>\$309.00</b>		
	W 188.5 x D 15 x H 27 cm			

### Storage Bed / Headboard / Walnut

	<b>37497887</b> Single	<b>\$209.00</b>		
	W 105.5 x D 6 x H 81 cm			
4	<b>37497900</b> Double	<b>\$289.00</b>		
	W 148.5 x D 6 x H 81 cm			
	<b>38371328</b> Queen	<b>\$309.00</b>		
	W 168.5 x D 15 x H 27 cm			
	<b>38371335</b> King	<b>\$339.00</b>		
	W 188.5 x D 15 x H 27 cm			

**Attaching a Headboard**  
 Old-model storage bed + Headboard → Cannot be attached (\*)  
 New-model storage bed + Headboard → Can be attached  
 \* This is due to the structure of the old-model storage beds.  
**How to Distinguish New-model and Old-model Storage Beds**  
 Check the shape of the fixing screws on the front panel of the drawer.  
 Older model → ⊕ Crosshead screw    Newer model → ⊙ Hex-head screw

\* Due to the nature of the material, oak may have a unique pattern called "tiger grain."  
 \* The characteristics of natural wood, such as the colour and grain pattern, may vary in appearance depending on the material.

# Mattresses

Five kinds of coil mattress and a non-coil mattress are available to suit the type of comfort that you desire.

The coil mattress is a mattress with well-considered functions of core materials.

Non-coil mattress consists of only natural materials which provide a great sleeping comfort by bringing out the features that materials originally hold.

## Spring mattresses with five types of comfort.

MUJI spring mattresses use the minimum required amount of filling material, such as urethane foam, in order to maximise the comfort provided by the coil springs. The comfort levels vary depending on the number and thickness of coils. The non-woven fabric wrapping the coils is highly breathable, preventing moisture from becoming trapped inside the mattress.



### Mattress size chart

\* Bonnell Coil Mattress: 18 cm in height

Single	Double	Queen	King
W 97 x D 195 x H 19 cm	W 140 x D 195 x H 19 cm	W 160 x D 195 x H 19 cm	W 180 x D 195 x H 19 cm



### Mattress with numerous coils that ensures a stable sleeping posture

The increased number of coils enables the mattress to more evenly distribute your body weight, reducing the pressure on your spine and lower back. The coils work together to conform to the shape of your body, providing a well-balanced and stable posture for longer periods of time.

#### High Density Pocketcoil Mattress

<b>15783724</b>	Single	Weight: 22 kg	<b>\$799.00</b>
<b>15783748</b>	Double	Weight: 32 kg	<b>\$1199.00</b>
<b>15783755</b>	Queen	Weight: 39 kg	<b>\$1499.00</b>

Double / Queen / King

Coil arrangement (staggered)

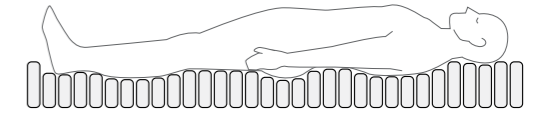
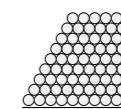

### Mattress with independent coils that evenly supports body weight across many dots

This mattress is constructed with a dense arrangement of independent coils that function as numerous dots to hold your body weight and provide well-balanced support. The mattress ensures a stable posture and reduces the amount of wobble and sinking.

#### Pocketcoil Mattress

<b>18094844</b>	Single	Weight: 23 kg	<b>\$499.00</b>
<b>18094868</b>	Double	Weight: 34 kg	<b>\$799.00</b>
<b>37096585</b>	Queen	Weight: 45.5 kg	<b>\$999.00</b>
<b>61854182</b>	King	Weight: 20 kg	<b>\$1199.00</b>

Double / Queen / King

Coil arrangement (staggered)

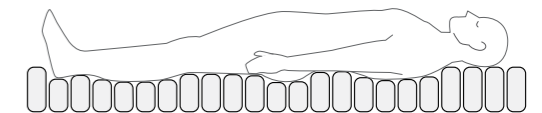
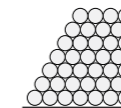

### High resilience mattress that provides secure body support

This mattress features an interlocking design of hourglass-shaped springs that firmly support your body weight across the entire surface. The mattress uses Bonnell coil springs, which are currently the most prevalent and reliable type of mattress-coil use.

#### Bonnell Coil Mattress

<b>15901838</b>	Single	Weight: 18.5 kg	<b>\$239.00</b>
<b>15901852</b>	Double	Weight: 31 kg	<b>\$399.00</b>

Quality and comfort has been improved by increasing the amount of coils and filling material.

Double / Queen

Coil arrangement (horizontally lined)

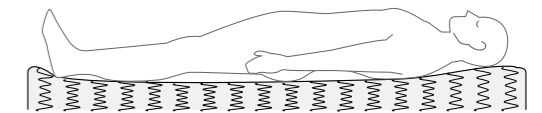
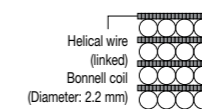





### A coil-less mattress made from nature.

Materials have been carefully chosen for this mattress, and it is made from wool, latex, coco fibre, and cotton. The structure takes full advantage of the materials' features, giving you a comfortable sleep. A specification which enables easiness to fall into sleep and to turn over during sleeping was the focused point of development.

#### Coil-Less Mattress

<b>38369400</b>	Queen	Weight: 57 kg	<b>\$1899.00</b>
<b>38369417</b>	King	Weight: 70 kg	<b>\$2099.00</b>

Cotton, wool, coco fibre, latex

\* This product consists of the topper part and lower base part (two parts).

Double / Queen / King

#### Carefully selected materials

##### Wool

We selected wool from among French-produced wool that is bulky, resilient, well-aerated due to plushness. It is also highly moisture-wicking as it is made of thick fibres.

##### Cotton

With long fibres, it is soft on the skin with minimal fluff, and features a great strength and constant quality.

##### Latex

High-quality latex made in Malaysia, a major manufacturing place of natural rubber, is used. The latex features incredibly high resilience and durability.

##### Coco fibre

In India, coconut is called "the Tree of life" as every part of the coconut is used, including root, trunk, leaves, and fruit, and cultivated over 4,000 years. It offers durability and ventilation.

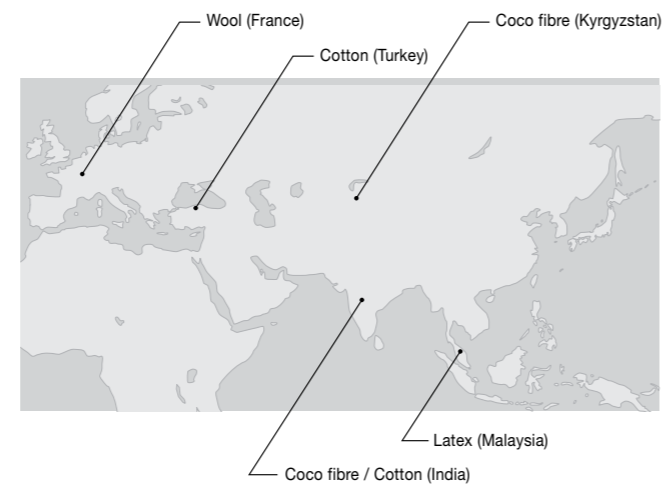
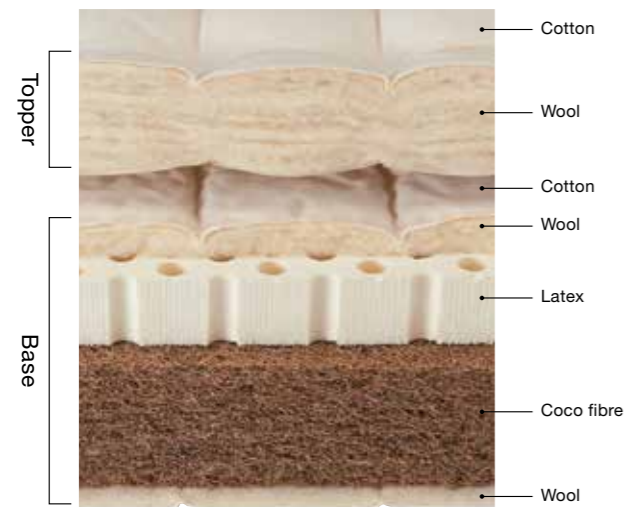

#### Bed mattresses that ensure the long life of your bed frame

To ensure the long-term use of your bed frame, it is recommended that you use a bed mattress that provides superior body-weight distribution. When using a futon mattress on a bed frame, your body weight is applied directly to the bed board, which can eventually lead to problems such as cracks.

#### Mattress pad that protects your mattress and absorb perspiration

Because the mattresses are designed for use with mattress pads, no quilting is incorporated into the surface, and emphasis is placed on providing an evenly distributed level of strength in the springs and filling materials. Make sure to use a mattress pad to protect your mattress and absorb perspiration.

#### Precautions

Make sure to periodically ventilate the mattress by standing it on an end. Moisture may build up inside the mattress if it is always kept on the bed frame, possibly leading to the formation of mould. Also, make sure to rotate the head/feet and flip the mattress over. The strength of springs may deteriorate if a load is continuously applied to the same place. By changing the mattress orientation and distributing your body weight more evenly over time, you can reduce the load on the springs.

\* To prevent the mattress from sagging unevenly, make sure that your weight on the mattress is distributed evenly over time.

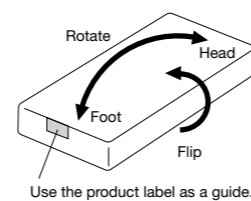

## Bed Pads

Choose from a variety of bed pads to suit your preferences.

Our selection ranges from thick pads that provide excellent cushioning, to those made with natural materials that provide excellent moisture absorption and dissipation. The bed pads are machine washable, ensuring that you can always keep them clean.



#### With easy-to-dry polyester filling.

A hygienic bed pad with easy-to-dry polyester filling.

#### Polyester Bed Pad With Elastic

<b>37288157</b>	Single	100 × 200 cm	Wadding weight: 0.80 kg	<b>\$56.00</b>
<b>37288171</b>	Double	140 × 200 cm	Wadding weight: 1.12 kg	<b>\$83.00</b>
<b>37288188</b>	Queen	160 × 200 cm	Wadding weight: 1.28 kg	<b>\$99.00</b>

Outer shell: 52% cotton, 48% polyester  
Wadding: 50% cotton, 50% polyester  
[Machine washable (in laundry net)]

#### Can be used with a mattress or futon

You can use it by simply placing it on top of your mattress or futon. There are three types to suit your needs.

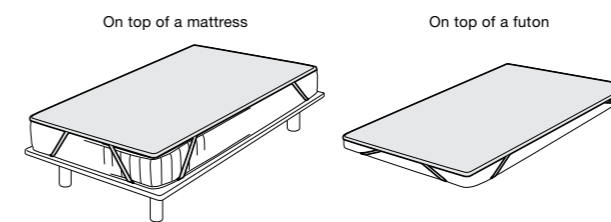

Elastic is added to prevent slipping. (same for all)

## Pillows

The "pillow" is an essential part of sleep that accounts for one third of each day. Choose a pillow to your liking from different materials, firmness, and elasticity.



**Feather**  
Waterbird feathers do not settle easily and have moderate resilience providing soft touch.

### Pillow

**15828494** 43 x 63 cm Filling weight: 0.7 kg **\$19.00**  
**15828500** 50 x 70 cm Filling weight: 0.9 kg **\$23.00**

Outer shell: 100% cotton, down-proofed finish  
Inner shell: 100% polyester Filling: 95% feather, 5% down  
[Dry-cleaning only (using a petroleum-based detergent)]

This pillow uses waterbird feathers which are light and maintain volume. This pillow is characterised by the comfort of a soft enveloping feel around one's rear part of the head.

\*1



**Pipe / Polyester cotton**  
This product has more elasticity and superb breathability. It uses polyester cotton and has a reversible design.

### Washable Pillow One Side Pipe

**38973386** 43 x 63 cm **NEW** **\$59.00**

Outer shell: 100% polyester Wadding: 100% polyester  
Filling: polyethylene resin  
[Machine washable (in laundry net)]

This pillow uses pipes with excellent breathability on one side, and the height of the top and bottom edge is different. The arched shape of the pillow is designed to fit your shoulder line.

\*1



**Urethane Foam Low Repulsion Quilted**  
This pillow slowly sinks when you rest your head on it, and it characteristically plump with fibres.



Cross section

### Urethane Foam Low Rebound Quilted Pillow

**37288607** 43 x 63 cm **\$69.00**

Outer shell: 85% polyester, 15% cotton Wadding: 100% polyester  
Stuffing: urethane foam  
[Non-washable]

This pillow uses a low-rebounding material for its filling. This pillow is characterised by the comfort of a soft enveloping feel with polyester wadding.



**Urethane Foam Chip**  
Made from a blend of gently sinking, low repulsion urethane and moderate resilience, high repulsion urethane for a soft finish.

### Urethane Foam Chip Pillow

**37750364** 43 x 63 cm **\$33.00**

Outer shell: 57% polyester, 43% cotton Stuffing: urethane foam  
[Non-washable]

Slow-sinking low-rebounding urethane has been mixed at a perfect blend with high-rebounding urethane having moderate elasticity.

## Futon Mattresses

Futon mattresses to choose from to suit your preference. From items with the shape of the urethane devised to pursue comfort, items that can be washed in a washing machine, and items made using natural wool.



### Urethane mattress ensures you a comfortable sleep

Cutting the urethane foam to create protrusions and recessions creates a comfortable futon mattress which supports the body at points. The outer shell can be taken off for washing which enables clean use.



### Profile Urethane Foam Cutting Futon

**37288249** Single 100 x 200 cm Weight: 3.6 kg **\$289.00**

Outer shell: 85% polyester, 15% cotton Base: urethane foam

\* Wash after reading the instructions for your home washing machine.

(Some washing machines may not be suitable for use)

\* The urethane foam cannot be washed.



### Wool is a natural functional material

Natural wool which is said to have excellent moisture releasing properties has a long history of being used for futons. A comfortable futon mattress featuring padding of a wave-like structure in consideration of breathability and durability wrapped with a blended cotton of wool and polyester.



### Wool Polyester Quilted Futon

**37107854** Single 100 x 210 cm Weight: 3.9 kg **\$189.00**

Outer shell: 100% cotton Base: 100% polyester

Padding: 50% wool, 50% polyester

Wadding: 100% polyester



### A mattress to use with futon mattresses

Combined use with a futon mattress adds to the cushion. Raising the height from the floor also prevents cooling from the surface which makes it perfect for use on flooring materials. The fabric of the outer shell can be taken off to be washed. The fabric of the outer shell and the wadding are also available separately for replacement.



### Polyester Hard Mattress For Futon

**18387403** Single 95 x 210 x 4 cm Weight: 2.8 kg **\$93.00**

Outer shell: 50% polyester, 50% cotton [Machine washable (in laundry net)]

Base: 100% polyester [Non-washable]

# Body Pressure Distribution Urethane Mat

Create a comfortable sleeping environment that helps you sleep more soundly.  
Choose between the hard type and the soft type, depending on the type of bedding you use.

You can choose from 2 types: hard and soft.



Body Pressure Dispersion Urethane Mat Hard			
<b>38389132</b>	Single	Weight: 3.5 kg	<b>\$209.00</b>
<b>38389156</b>	Double	Weight: 4.9 kg	<b>\$339.00</b>

Body Pressure Dispersion Urethane Mat Soft			
<b>38389163</b>	Single	Weight: 3.5 kg	<b>\$209.00</b>
<b>38389187</b>	Double	Weight: 4.9 kg	<b>\$339.00</b>



Urethane cross section



Urethane cross section

(Common to both hard / soft types)  
Outer shell: 100% polyester [Machine washable (in laundry net)] Filling: Urethane foam [Non-washable]  
Made with breathable urethane which distributes your weight. Use on top of a bed mattress or on top of a futon.  
\* The urethane itself cannot be washed. The cover can be removed and washed.



Usage Example / Futon



Usage Example / Mattress

## Mattress Size Chart

Small	W 80 x D 195 x H 3 cm
Single	W 97 x D 195 x H 3 cm
Semi-double	W 120 x D 195 x H 3 cm
Double	W 140 x D 195 x H 3 cm
Queen	W 160 x D 195 x H 3 cm
King	W 180 x D 195 x H 3 cm

## Personal sleep environment

You can use it by simply placing it on top of your mattress or futon. You can chose either the hard type or the soft type that fits your sleeping style and comfort.

## Superior weight distribution

In order to sleep you, you need good comfort. When sleeping, weight is distributed more to the hips and middle of the back. The ideal softness and resilience of the urethane foam distributes your body weight evenly.

### Weight distribution comparison

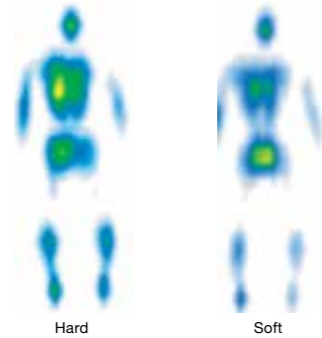

\* Generally, bedsores are said to occur at 32 mmHg (blood vessel internal pressure).  
\* When using with a mattress.  
Male subject with a height of 167 cm and weight of 53 kg

## Highly-moisture releasing urethane

It is said that a person sweats about 1 cup of sweat while sleeping. Using urethane, with great moisture absorption and releasing properties, we created a product with great air flow.

### Moisture absorption and releasing experiment

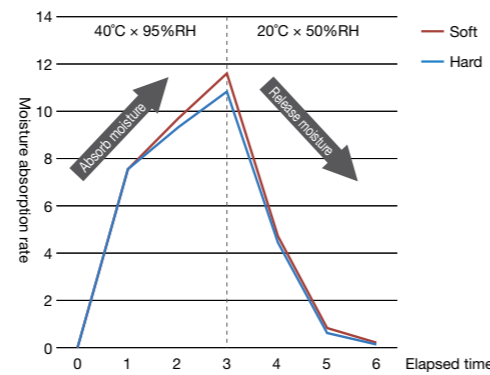

\* Ordinary urethane does not have moisture absorption and releasing properties.  
\* High moisture absorption and releasing properties

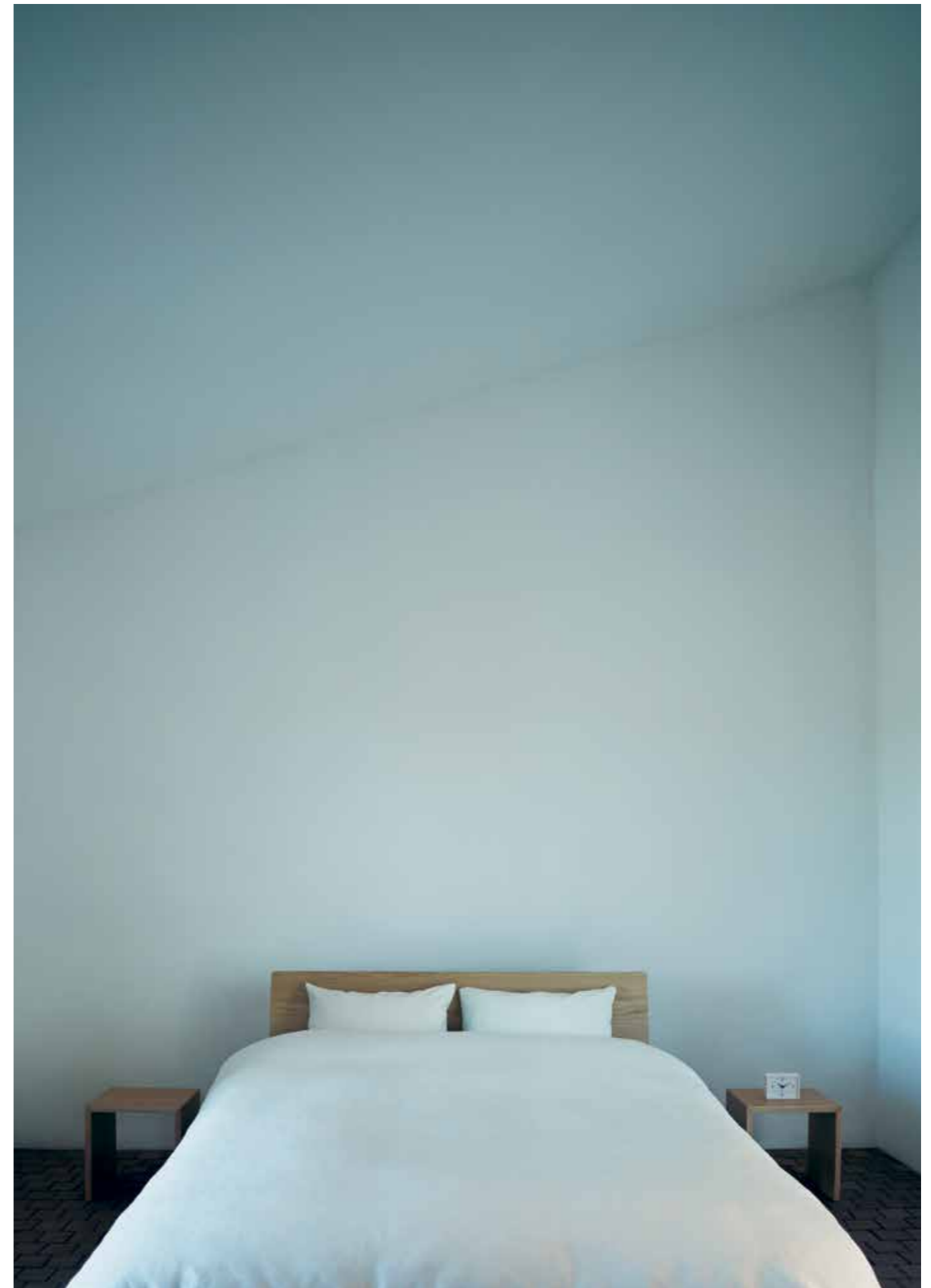



Bed Frame P70

All for a comfortable night's sleep.

Launched in 1991, the Mattress With Legs continues to be popular after all this time. This product moves beyond conventional concepts, creating a bed by simply adding legs to the mattress. This is the essence of MUJI—a streamlined product that offers exactly what you need for a good night's sleep.

We brought the basic concept of our beds to our Bed Frame, as well. The Bed Frame in a simple design can be combined with an optional headboard, detachable legs, and under-bed storage products to suit a variety of purposes and styles, creating just what you want and need. The small size bed fits together seamlessly. Use them separately or place two side by side for a queen size.

In sizes and specifications designed for different uses, the Bed Frame can be combined and rearranged to adapt as your needs change over the years.

In addition to coil mattresses, MUJI offers the Coil-Less Mattress that features natural materials. Using wool with its excellent ability to absorb and release moisture, we add latex made from natural materials and coconut fibre to not only ensure a good night's sleep, but also to reduce its environmental impact. MUJI uses organic cotton in bedding covers to protect the people who manufacture our products, as well. Natural fibres and fabrics are another great way to get a sounder, more comfortable night's sleep.



“Why not experience the comfort of sleeping in a bed built to your specifications?”



## SOFAS & LIVING ROOM FABRICS

### Flexibility in style gives more comfort.

Life is certainly not a repeat of the exact same thing, day after day. Your taste changes, and you create new habits through time. Over the years, you may move to a new place; your family may grow; kids may leave home. MUJI's vision is to create products that flexibly correspond and embrace the changes of lifestyles.

We all spend a lot of time in the living room, and this room too can be transformed simply by changing the furniture or fabric. Instead of facing each other, place

sofas back to back to create a new area in the room for relaxing. Sofa covers do not necessarily need to be a single colour. The most important thing is creating a calm and comfortable space where everyone can relax every day. You may find inspiration from your life now to create your ideal home.



## Sofas



**Beads Sofa** ..... 92

A sofa that changes shape to support you as you relax in any position. Choose from nine different covers.



**Unit Sofa** ..... 94

A truly comfortable unit sofa with modules to combine and arrange to suit your space and style of relaxing.



**Lounge Sofa** ..... 101

A seatback that easily reclines at the touch of a lever. Stable and supportive hold for serious comfort.



**Floor Chair** ..... 101

A simple floor chair that reclines to six different positions and blends seamlessly into any interior.



**Living Dining Series** ..... 96

A series sized especially to be space-saving, yet convenient.



**Sofas** ..... 98

Sofas in simple, conventional shape. Choose sofa cushions filled with down feathers, feathers with pocket coils, or urethane, for the best comfort for you.



**Sofa Covers** ..... 102

A selection of 11 sofa covers in different materials and colours. Choose the one that best suits your style and décor.

# Beads Sofa

The beads sofa changes its shape freely to fit your leisure position. A new type of beads sofa cover is now available, which uses the same type of fabric for all six sides. The covers feature a soft, natural texture.



### Beads Sofa

**61049182** \$169.00  
 Beads sofa + cover  
 W 65 x D 65 x H 43 cm  
 \*1 \*2 \*3

The micro particle beads maintain its shape and create a extremely soft feel.



### Cover For Beads Sofa

1 <b>61048888</b> Grey beige	2 <b>37287594</b> Charcoal grey	3 <b>61048871</b> Dark brown	
4 <b>76580294</b> Navy	5 <b>37137516</b> Coral pink		Each \$49.00
6 <b>37287600</b> Denim / hickory	7 <b>37100619</b> Denim / navy		Each \$79.00

### Polyester Cover For Beads Sofa

8 <b>38986973</b> Beige	9 <b>38634911</b> Dark brown	Each <b>\$109.00</b>
-------------------------	------------------------------	----------------------

Cover: 100% polyester  
 Polyester-jersey fabric is used on all six surfaces. The sides are backed with a non-stretch fabric liner. Same as the existing models, you can enjoy the different seating comfort depending on the orientation.

### A sofa created from the voices of our customers

At MUJI, we promote a way of manufacturing that the voices of our customers are reflected in the product development. This "beads sofa" is one of the products that have been created as a result of such manufacturing project.

### Sitting on a "vertically placed" sofa

The sofa wraps around the lower back and neck to support any posture that one wishes to relax in. Perfect when reading or watching TV.

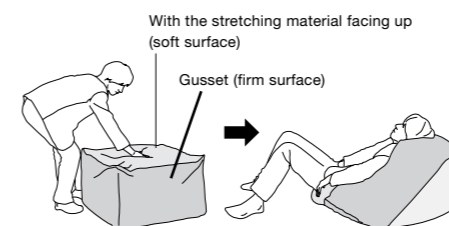

### Sitting on a "horizontally placed" sofa

The sofa spreads in a circular manner to allow the body to sink in deeply and be supported. Perfect for taking a nap.

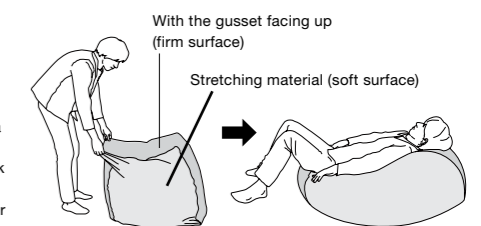

\*1 During the course of use, the beads may settle and cause a slight variance in thickness. \*2 The sofa cannot be used alone. Be sure to use it with a cover.  
 \*3 The Beads Sofa cannot be washed.  
 \* Slight shrinking of the cover may occur by dry cleaning.

# Unit Sofa

Unit sofas consist of a small number of parts that can be arranged into various configurations. The size and structure of the parts have been carefully modified to provide more relaxing seating comfort.



Unit Sofa / With Armrest / L NEW  
38986942 \$569.00



Unit Sofa / Armless / L NEW  
38986959 \$489.00



Unit Sofa / Ottoman / L NEW  
38986966 \$319.00



Unit Sofa / With Armrest / S NEW  
38666318 \$489.00



Unit Sofa / Armless / S NEW  
38666325 \$399.00



Unit Sofa / Ottoman / S NEW  
38666332 \$289.00

\* The unit sofa series shown in the photographs is with Linen Cotton cover for Unit Sofa / Ecru (sold separately).  
 \* Always use the product with a cover (sold separately). A selection of covers is available on P162-163.

These sofas are carefully designed for seating comfort and can be freely combined into a variety of configurations.

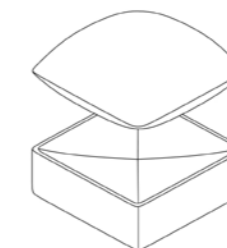

The seat cushions are constructed from a concave moulded urethane base topped with a bag stuffed with crushed urethane foam, for plush seating comfort.

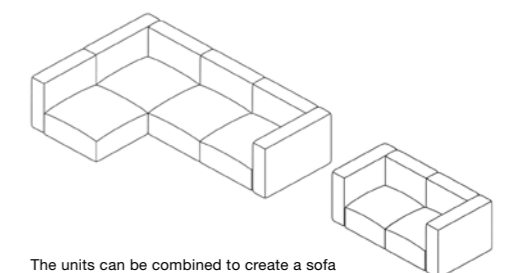

The units can be combined to create a sofa set for a large living room, or they can be used individually as a compact sofa. You can freely select the combination that best suits your lifestyle and living space.

## Sofa modules that can be mixed and matched to fit your lifestyle

Whether you want to use a single module as a roomy seat for one person, or combine multiple modules to use as a complete sofa, you can select a combination that fits your living environment.

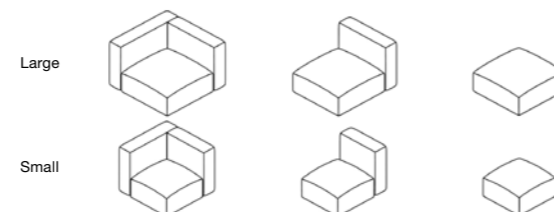



## Living Dining Series

Living comfortably in a compact space. These products have been developed based on such concept.  
A table with a depth of 80 cm for dining is also available.



### Table with height of 60 cm that makes your room feel spacious

The 60 cm height of this table makes it suitable for use whether you are enjoying meals in the dining room or relaxing in the living room.

Cushions of Bench and Sofa Chair were reviewed with a focus on comfortable seating.



### Living Dining / Table

1	[38727798] 1 / D 65 cm W 150 x D 65 x H 60 cm	\$649.00
	[38727804] 2 / D 65 cm W 130 x D 65 x H 60 cm	\$569.00
	[38727811] 3 / D 80 cm W 150 x D 80 x H 60 cm	\$889.00



### Living Dining / Bench

2	[38734376] Bench 1 W 115 x D 46 x H 40.5 cm	\$439.00
---	--	----------

This bench can be used alone or in combination with the table. Designed for comfort. The material for the cushion has been improved for better comfort and durability.

3	[3870017] Bench 2 W 58 x D 46 x H 40.5 cm	\$259.00
---	--	----------

This bench can be used as an ottoman in combination with the sofa chair. The material for the cushion has been improved for better comfort and durability.

\* Be sure to use this item with the separately sold cover. Refer to P162-163 for our lineup of covers.

### Living Dining / Sofa Chair

4	[38369998] W 55 x D 78 x H 77 (seat surface: 41) cm	\$439.00
---	--	----------

This item has been designed so that the seat surface is at a comfortable height and a size that allows one to sit with their legs crossed. The material for the cushion has been improved for better comfort and durability.

\* Be sure to use this item with the separately sold cover. Refer to P162-163 for our lineup of covers.

### Living Dining / Sofa Chair Arm

5	[15253739] Set of 2	\$49.00
---	---------------------	---------



### Living Dining / Sofa Chair Connecting Plate

6	[15549597] Set of 2	\$16.00
---	---------------------	---------

Parts for coupling sofa chairs. The sofa chairs can be coupled to form a sofa for two or a sofa for three.

\* The armrests cannot be attached to the coupled sections of the sofa.

### Oak / Flat Type / Sliding Door / AV Rack

7	[38318347] Width 150 cm W 150 x D 35 x H 36.5 cm 3 adjustable shelves included	\$549.00
---	---	----------

Inside dimensions of shelf (when adjustable shelf is installed in the centre)  
(Top/bottom) W 47 x D 28.5 x H 9.5 cm

8	[37153653] Width 110 cm W 110 x D 35 x H 36.5 cm 2 adjustable shelves included	\$469.00
---	---	----------

Inside dimensions of shelf (when adjustable shelf is installed in the centre)  
(Top/bottom) W 52 x D 28.5 x H 9.5 cm

An AV rack with a smaller height and depth. This rack has been designed with sliding doors in the back panel for easy wiring.

\* With the W 150 cm type, be sure to attach the supplementary legs when placing objects that weigh more than 20 kg on the top surface.

\* The supplementary legs are not included with the W 110 cm type.



Back

# Sofas

One can choose a preferred comfort from a selection of down feather, feather, and urethane. Parts can be replaced which enables use over many years. The down feather type is a sofa that is filled with down feather and is comfortable to sleep on.

## Feather Cushion

This sofa combines the soft cushioning of feathers for the back and stable, also-used-for-bed pocket coils for the seat. Sitting on the sofa feels like being surrounded by comfort.

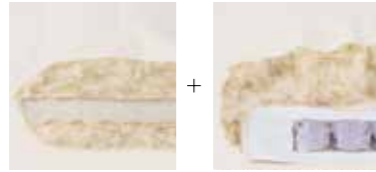

Back: Urethane + feather (mixed with urethane)

Seat: Pocket coils + feather (mixed with urethane)

\* The legs can be selected from either natural or brown.  
\* Refer to P162-163 for our lineup of covers.

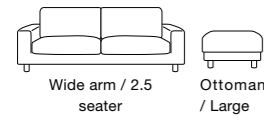

Sofa / Wide Arm / Feather Cushion  
1 **37408135** 2.5 seater **\$1099.00**  
W 190 x D 87.5 x H 75 cm (with legs attached)



Sofa / Feather Cushion / Ottoman / L  
**37408104** **\$369.00**  
W 77 x D 54.5 x H 40 cm (with legs attached)

By adding an Ottoman / L to Sofa, the Ottoman can be used not only as an ottoman but also to make an 1-seater or regular sofa possible to use as a bigger couch. Greater variation in combinations increases the range of how the sofa can be used which makes it perfect for use over many years.



## Urethane Foam Cushion

A kind of urethane cushions for firm comfort. This item uses urethane that has a perfect firmness for sitting on. The urethane cushions in the back and seat surface that are not too soft will firmly support one's body, making it easy to stand up and sit down.



Back: Urethane

Seat: Urethane

\* The legs can be selected from either natural or brown.  
\* Refer to P162-163 for our lineup of covers.

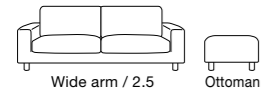

Sofa / Wide Arm / Urethane Foam Cushion  
2 **38369974** 2.5 seater **\$799.00**  
W 190 x D 87.5 x H 75 cm (with legs attached)



Sofa / Urethane Foam Cushion / Ottoman  
**47276916** **\$129.00**  
W 54.5 x D 35 x H 35 cm (with legs attached)

The compact size makes the product also easily usable as a stool.

\* This product does not have a steel-frame structure. (wooden frame structure)

### Wide arm Sofa

Three types, each offering its own comfortable seating experience, are available: down feathers, feather, and urethane.

### Ottoman

A choice of a large, spacious size for relaxing or of a compact size that can be easily used also as a stool is available.

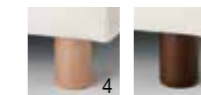

Legs For Sofa  
4 **47277029** Natural  
5 **47277036** Brown  
Each **\$33.00**  
dia. 6 x H 10 cm  
Beech Set of 4

\* Be sure to use this item with a cover.

\* Down/feather products may have a smell immediately after purchase or in seasons with higher humidity. In such cases, use your hands to push out the air that smells to replace it with fresh air and use the product after leaving it for 3 or 4 hours in a well-ventilated area.

\* The fabrics used with down feather and feather products are finished with a treatment which prevents the filling from coming out. Refrain from sticking a needle or safety pin. Some feathers may come out from the seams. A small amount will not affect use.

## Headrest

An optional part for those who wish to enjoy the comfort of a high-back sofa. This can be easily installed by simply inserting the part into the main body.



### Sofa / Headrest

1 **76580690** W 77 cm for 2.5 seater **\$89.00**

Simply attaching the headrest will convert the Sofa into a high-back sofa to lean on. Be sure to use this item with the separately sold cover.

\* The headrest unit cannot be installed on the older models of Sofa / Wide Arm (2007) and Sofa (2005).

## Ensuring long-term, comfortable use

The back cushions and seat cushions are available as separate parts. With the ability to remove and replace cushions when they become compressed, you can ensure long-term, comfortable use of your sofa. Covers are also sold separately, enabling you to choose the types that you desire. The covers can also be removed and dry-cleaned if they need to be cleaned.



## The structure of the frame

The use of a steel frame structure provides strength and sturdiness. Another amazing feature is the comfortable seating provided by the cushions, which have been painstakingly designed and redesigned to perfection.

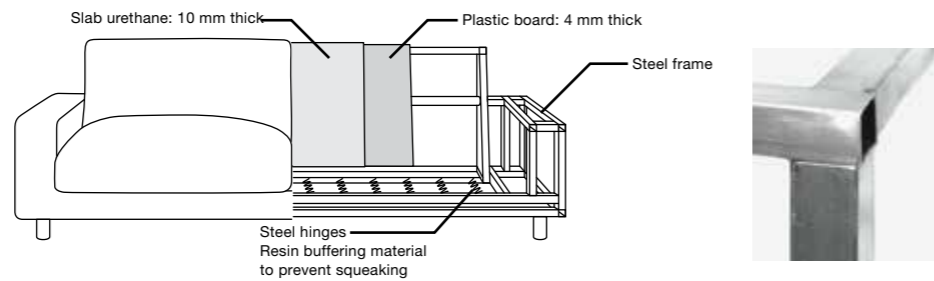

## Lounge Sofa

A sofa that can be reclined easily with a touch of a lever and in which you can relax.

A sense of stability and of being held into a comfortable seat is like those of a car seat.

A cover can be chosen according to your preference.



### Lounge Sofa

1 **37792104** **\$729.00**

Approx. W 65 x D 90 x H 85 cm (seat height 35.5 cm)

\* A selection of covers is available on P162-163.

### Lounge Sofa / Ottoman

2 **37792111** **\$289.00**

Approx. W 65 x D 43 x H 35 cm)

\* A selection of covers is available on P162-163.

A cover can be chosen according to your preference

Numbers of different materials and colours can be chosen according to the ambience of the room or personal preference. Designed to be easily removable.

\* A selection of covers is available on P162-163.

Equipped with a reclining function

The back can be easily reclined with a touch of a lever and can be adjusted to the desired angle (total of nine positions). The neck support can be folded 180° forward, supporting your lower-back when seated closer to the edge of the chair.



## Floor Chair

This simple floor chair matches any kind of room.



### Floor Chair (body)

1 **18481286** Large **\$79.00**

W 57 x D 102 x H 10 cm (When flat)

2 **18481293** Small **\$59.00**

W 46 x D 86 x H 10 cm (When flat)

This floor chair has a six-pitch reclining feature. Its covering can be removed and washed.

### Cotton Canvas Cover For Floor Chair / Ecru

3 **37746886** For Large **\$39.00**

**37746930** For Small **\$29.00**

100% cotton [Dry cleaning only] \*1



Ecru

### Cotton Cover For Floor Chair / Beige

**15999057** For Large **\$43.00**

4 **15999064** For Small **\$33.00**

100% cotton [Dry cleaning only] \*1



Beige

### Cotton Cover For Floor Chair / Dark Brown

**15999699** For Large **\$43.00**

**15999705** For Small **\$33.00**

100% cotton [Dry cleaning only] \*1











Dark Brown

\*1 Due to the nature of the product, the product will shrink by dry-cleaning.

# Sofa / Chair Covers

Choose your favourite style or match your room decor with sofa covers that come in numbers of different colours and materials.

Sofa cover price chart

Cover			Cotton Canvas 100% cotton	Cotton 100% cotton		Cotton Polyester 70% cotton, 30% polyester		Cotton Chenille 100% cotton		Cotton Denim 100% cotton	
			 Ecrú	 Beige	 Dark Brown	 Beige	 Dark Brown	 Light Gray	 Green	 Blue	 Navy
Sofa	2.5 Seater	Feather / Urethane	-	<a href="#">15998951</a> \$249.00	<a href="#">15999118</a>	<a href="#">37608320</a> \$369.00	<a href="#">37608337</a>	<a href="#">61048499</a> \$369.00	<a href="#">61048369</a>	<a href="#">38936640</a> \$369.00	<a href="#">38936800</a>
	Ottoman, Large	Feather	-	<a href="#">15999019</a> \$79.00	<a href="#">15999170</a>	<a href="#">37609310</a> \$109.00	<a href="#">37609327</a>	<a href="#">15062553</a> \$109.00	<a href="#">15062546</a>	<a href="#">38936701</a> \$109.00	<a href="#">38936862</a>
	Ottoman	Urethane	-	<a href="#">15999002</a> \$49.00	<a href="#">15999163</a>	<a href="#">37609334</a> \$63.00	<a href="#">37609341</a>	<a href="#">61048543</a> \$63.00	<a href="#">61048437</a>	<a href="#">38936695</a> \$63.00	<a href="#">38936855</a>
	Headrest		-	<a href="#">15999033</a> \$36.00	<a href="#">15999255</a>	<a href="#">37608368</a> \$39.00	<a href="#">37608375</a>	<a href="#">61048567</a> \$39.00	<a href="#">61048437</a>	<a href="#">38936725</a> \$39.00	<a href="#">38936886</a>
Living Dining Series	Sofa Chair		-	-	-	<a href="#">37610866</a> \$99.00	<a href="#">37610873</a>	<a href="#">15256471</a> \$99.00	<a href="#">15256488</a>	<a href="#">38936749</a> \$99.00	<a href="#">38936909</a>
	Bench	01	-	-	-	<a href="#">37610880</a> \$79.00	<a href="#">37610897</a>	<a href="#">15257096</a> \$79.00	<a href="#">15257102</a>	<a href="#">38936756</a> \$79.00	<a href="#">38936916</a>
		02	-	-	-	<a href="#">37610903</a> \$49.00	<a href="#">37610910</a>	<a href="#">15257133</a> \$49.00	<a href="#">15257140</a>	<a href="#">38936763</a> \$49.00	<a href="#">38936923</a>
Unit Sofa	With Armrest	Large	-	<a href="#">38989547</a> \$179.00	<a href="#">38989585</a>	<a href="#">38989622</a> \$239.00	<a href="#">38989639</a>	-	-	-	-
		Small	-	<a href="#">37192492</a> \$149.00	<a href="#">37192591</a>	<a href="#">37609372</a> \$199.00	<a href="#">37609389</a>	-	-	-	-
	Armless	Large	-	<a href="#">38989554</a> \$149.00	<a href="#">38989592</a>	<a href="#">38989646</a> \$209.00	<a href="#">38989653</a>	-	-	-	-
		Small	-	<a href="#">37192508</a> \$119.00	<a href="#">37192607</a>	<a href="#">37610781</a> \$169.00	<a href="#">37610798</a>	-	-	-	-
	Ottoman	Large	-	<a href="#">38989561</a> \$119.00	<a href="#">38989608</a>	<a href="#">38989660</a> \$179.00	<a href="#">38989677</a>	-	-	-	-
		Small	-	<a href="#">37192515</a> \$93.00	<a href="#">37192614</a>	<a href="#">37610828</a> \$119.00	<a href="#">37610835</a>	-	-	-	-
Lounge Sofa	Main Unit		-	<a href="#">37792630</a> \$149.00	<a href="#">37792647</a>	-	-	-	-	-	-
	Ottoman		-	<a href="#">38309208</a> \$63.00	<a href="#">38309215</a>	-	-	-	-	-	-
Floor Chair	Large		<a href="#">47746886</a> \$39.00	<a href="#">15999057</a> \$43.00	<a href="#">15999699</a>	-	-	-	-	-	-
	Small		<a href="#">37746930</a> \$29.00	<a href="#">15999064</a> \$33.00	<a href="#">15999705</a>	-	-	-	-	-	-

\* Sofa covers are sized to fit snugly. See the instruction manual if you have difficulty fitting the covers on the sofa.  
 \* Only use dry cleaning for sofa covers. \* Slight shrinking may occur by dry-cleaning.  
 \* Covers for Sofa / Headrest are the same size for Down Feather Cushion / Feather Cushion / Urethane Foam Cushions.

Enjoy the fun of designing your own seating.



Unit Sofa P94

Furniture is a serious purchase, and sofas are especially so. Not only are they a large expense, but the sofa that works for you today may not always suit your life and family. MUJI's Unit Sofa is designed specifically to give you more freedom and versatility than a typical sofa can.

The Unit Sofa includes armed and armless modules that can be arranged and rearranged to create a variety of combinations. This line includes modules in two different widths and depths, as well as ottomans. These few pieces arranged in various combinations are great for furnishing rooms of any size and can be rearranged to adapt to changing tastes and lifestyles for years of long use. The arms on the armed modules can be moved to either side. MUJI's versatility comes not from adding things, but

from subtracting the unnecessary for greater flexibility.

MUJI carefully formulates manufacturing processes to achieve a sofa that looks great and also feels comfortable. The cushions are constructed to provide the most comfortable support and to resist wearing even after years of use.

Urethane chips provide even more cushioning for plump, soft seating.

The larger model with its deeper seat gives you even more room to relax in whichever position is most comfortable for you.

Our aim is a sofa that blends quietly with any lifestyle and integrates naturally with any space. MUJI helps create just the right space for you.

“Adapts seamlessly as your space and lifestyle changes.”



## TABLES, CHAIRS & DESKS

### Furniture becomes a part of the family.

Of the numerous items of furniture that we all use daily, the chair is undoubtedly the piece of furniture whose design has evolved the most. Today, people use stools for short breaks, dining chairs for meals, and lounge chairs for enjoying a little solitude. The chair is a functional extension of one's body and a compelling focal point of a room even when it is empty.

Tables and desks create the setting for a lifestyle together with chairs. The centerpiece of the table is the

friends and family who gather around it. This is a space like no other in the home. Desks, too, are a valuable space where people engage in work and concentrate on the tasks at hand.

MUJI furniture is not designed to be flashy. Rather, these pieces are made to age beautifully as they are used and enjoyed. MUJI creates quality furniture pieces that over time become part of the family and home they fill.

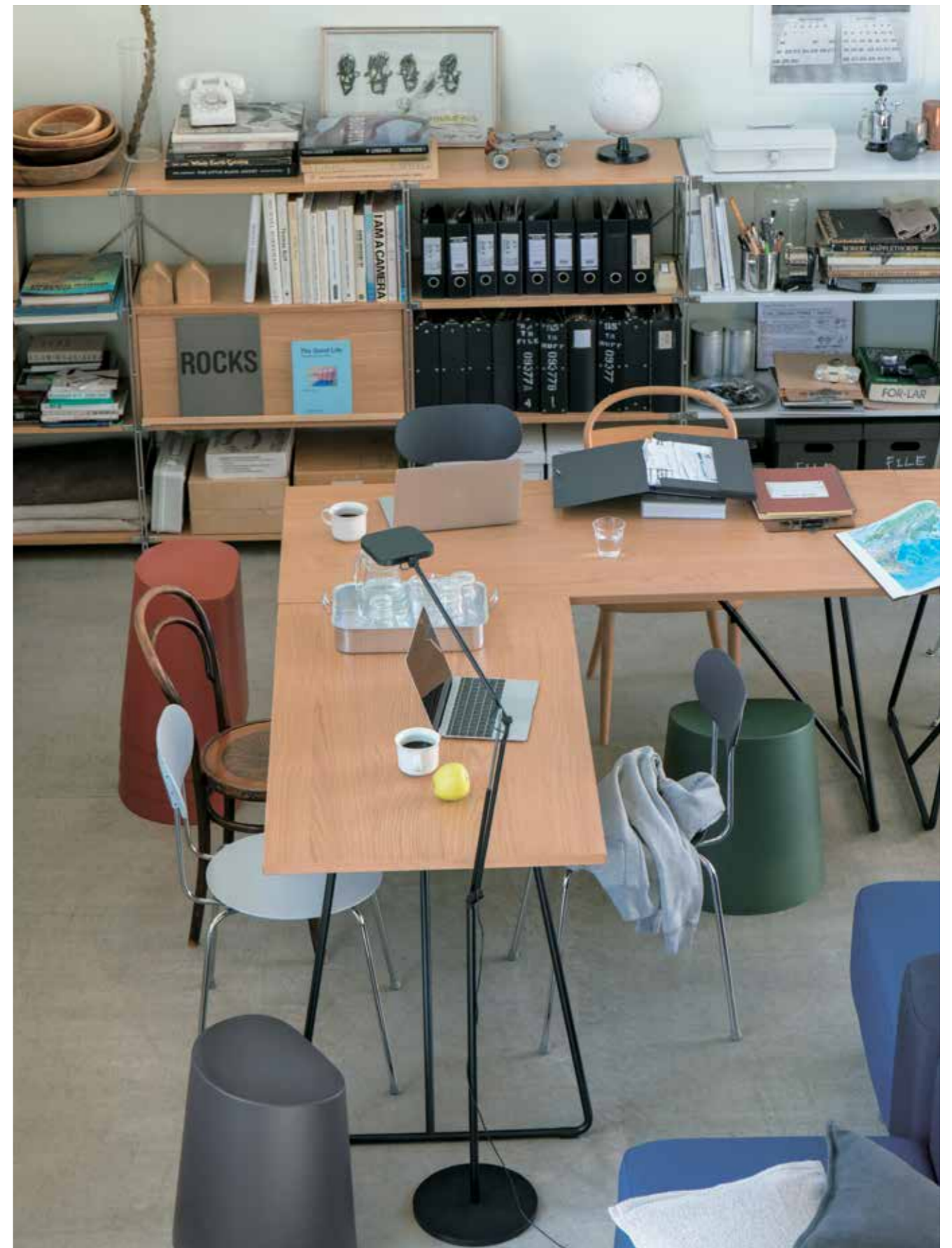

## Tables / Chairs



**Oak Round Leg Series** ..... 114

Designed in quality oak with skilled Japanese craftsmanship to make the most of the wood's natural character.



**Natural Wood** ..... 116

A furniture series made of natural wood that gains a richer, deeper look as it ages with use. Durable pieces for long years of use.



**Beech** ..... 120

A furniture series made from European beech wood in a smooth, round designs.



**Folding Table** ..... 118

A folding table that can be used not only for dining, but as a workspace, as well. It can be stored away in narrow spaces.



**Working Chair** ..... 123

A height adjustable chair with the option of added arm rests.

## Desks



**System Desk** ..... 122

A build-your-own type desk you design by combining your choice of desktop panel and legs for use as an office desk or a meeting table.



**Natural Oak** ..... 123

A furniture series in natural oak, a beautifully grained wood that gains a richer, deeper look as it ages.



## Oak Round Leg Series

We have made effective use of the material in its natural state, without eliminating knots, variations in darkness and lightness, and tiger grains. Each piece of this furniture is unique. High quality material has been worked and finished with passion by highly technically proficient Japanese artisans.



The seat is broad and has a gentle concavity to allow you to sit on the stool for a long time without growing weary of it.



### Oak / Round Legs / Table

1 **15901999** W 180 cm **\$1899.00**  
W 180 × D 85 × H 72 cm

2 **15901982** W 150 cm **\$1699.00**  
W 150 × D 80 × H 72 cm

Withstand load: 40 kg for tabletop



### Oak / Round Legs / Armchair

3 **15902040** **\$699.00**  
W 55.5 × D 50.5 × H 73 cm Seat surface: 44.5 cm

### Oak / Round Legs / Bench

4 **15902125** **\$729.00**  
W 100 × D 34 × H 44 cm

### Oak / Round Legs / Stool

5 **15902132** **\$499.00**  
W 52.5 × D 34 × H 44 cm

### Furniture that can be used for a long time

Our furniture efficiently uses oak that needs to have grown for nearly 100 years, and is made without nails or screws so that you can use it for just as long.

We paid close attention to the shapes of our furniture; oval shape of the table allows people to gather around even when there is more-than-usual number of people, and chairs with shapes that allow you to sit, stand, and change position with ease.

# Natural Wood and Oak

Furniture made with North American white oak which nicely ages by use.



Natural Wooden Table / 180 cm  
1 **15892402** Oak **\$1199.00**  
W 180 x D 80 x H 72 cm

Natural Wooden Table / 140 cm  
**15892398** Oak **\$939.00**  
W 140 x D 80 x H 72 cm



Natural Wooden Low Table / 120 x 60 cm  
**15880850** Oak **\$569.00**  
W 120 x D 60 x H 35 cm

Natural Wooden Low Table / 90 x 60 cm  
**15880843** Oak **\$469.00**  
W 90 x D 60 x H 35 cm

Natural Wooden Low Table / 90 x 45 cm  
**15880836** Oak **\$399.00**  
W 90 x D 45 x H 35 cm  
Withstand load: 40 kg for tabletop, 3 kg for each drawer  
This product is designed with a height of 35 cm for ease of use even when sitting on the floor.



Extension Table / 1  
3 **15877553** Oak **\$799.00**  
W 140 / 190 x D 80 x H 72 cm  
Withstand load: 40 kg for tabletop, 10 kg for each extension leaf



Natural Wooden Bench / Wooden Seat  
4 **15892419** Oak **\$309.00**  
W 100 x D 37 x H 44 cm  
Withstand load: 10 kg for middle shelf



Natural Wooden Side Table Bench / Wooden Seat  
**15892341** Oak **\$159.00**  
W 37 x D 37 x H 44 cm  
Withstand load: 15 kg for tabletop (when keeping items on top as a side table), 10 kg for middle shelf

\*Usage example



Natural Wooden Table Bench  
6 **15892426** Oak **\$739.00**  
W 120 x D 37.5 x H 44 cm  
Withstand load: 20 kg for storage unit  
A good height to use even as a low table and enough strength for use as a bench. The space under the seat can be used as a storage space.

\*Usage example



Natural Wooden Bench  
7 **15892358** Large / Oak **\$189.00**  
W 100 x D 30 x H 44 cm  
Seat surface: W 100 x D 14 cm  
**15892365** Small / Oak **\$159.00**  
W 45 x D 30 x H 44 cm  
Seat surface: W 43 x D 14 cm

A bench in the shape of a traditional bench that has been in use in China since old times, is compact and applicable to multiple purposes.

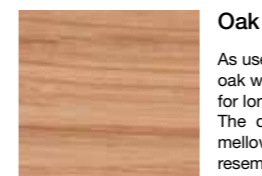

## Oak

As used for furniture and whiskey barrels since old times, oak which is hard, solid, and durable is a perfect material for long-lasting furniture.

The delicate and soft expression creates furniture with mellow impression. Patterns called "tiger grain" which resemble the pattern of a tiger and its delicate and gentle grain are characteristics of oak. The look of oak is enhanced as the material ages over time.

\* We recommend using placemats and coasters when dining.

\* Due to the use of natural wood, the colour of each product may slightly vary. The colour may also appear different under different lighting.

\* Due to the nature of the material, oak may have a unique pattern called "tiger grain."

\* The characteristics of natural wood, such as the colour and grain pattern, may vary in appearance depending on the material.

\* Withstand loads are calculated based on evenly distributed weight.

## Folding Table Stackable Stool

This table and stool set has a simple, minimalist design. Because the table's legs fold up and the stools can be stacked, you can make the best use of limited spaces.



### Folding tables designed for both individual and combined use

The simple design of the folding table makes it suitable for use in any location. The ability to use a single table by itself or multiple tables in combination provides additional versatility. When folded, the table has a thickness of 10 cm, enabling you to store it neatly away when not in use.

### Stackable stools designed for seating comfort

Stackable stools feature a concaved seating surface, and they are designed to reduce fatigue even when sitting for a long time. In addition, polyethylene caps are attached to the inner surface to prevent scratches when stacked.



### Foldable Table / Oak

1 **38369448** W 160 cm **\$479.00**

W 160 x D 70 x H 72 cm Thickness when folded: 10 cm

**38369431** W 120 cm **\$399.00**

W 120 x D 70 x H 72 cm Thickness when folded: 10 cm

This table's legs can be folded. It can be used both as a dining table and as a desk.



When folded



### Polypropylene Stackable Stool

2 **38369462** Dark grey

3 **38369479** Green

4 **38369486** Red

Each **\$39.00**

Approx. W 43 x D 34 x H 45 (seat surface 42) cm

Stacking limit: 5 stools

This is a stackable polypropylene stool.



When stacked

### Makes effective use of limited space.

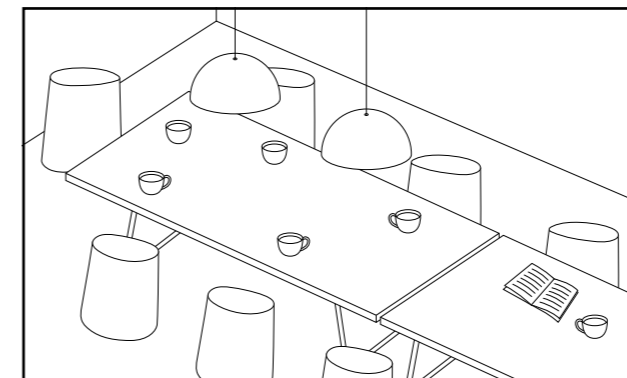

These items can be used to good effect in various places around the home. They can be used not only in the dining room but also in work spaces.

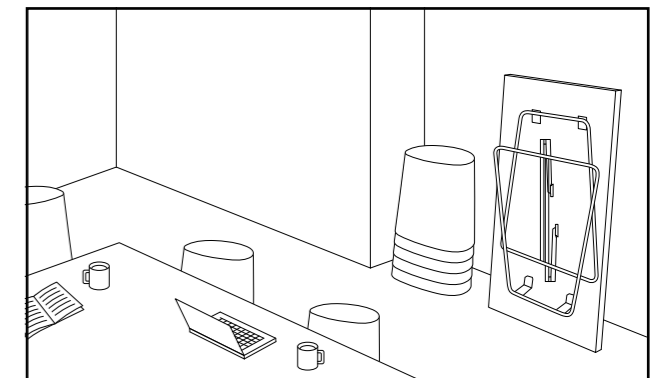

They can be stored compactly when not in use. The table has been designed with folding legs. The polypropylene stackable stools can be placed on top of one another, making effective use of limited space.

## System Desk

Build-your-own type desks are available with optional parts that enable you to customise the configuration, making them perfect for a wide range of applications.



\*Usage example



Desk (system type) combination price chart

	Top panel: Oak	Top panel: Melamine	Desk Legs	Combination price (Top panel: Oak)	Combination price (Top panel: Melamine)
W 120 cm	\$229.00	\$179.00	\$119.00	\$348.00	\$298.00
W 150 cm	\$259.00	\$219.00	\$139.00	\$398.00	\$358.00



\*Usage example

Desk Top Panel / Oak	
1 <b>37526464</b> W 150 cm	\$279.00
W 150 x D 60 x H 2 cm	
<b>37526428</b> W 120 cm	\$239.00
W 120 x D 60 x H 2 cm	

Desk Top Panel / Melamine / White	
<b>37526389</b> W 150 cm	\$249.00
W 150 x D 60 x H 2 cm	
2 <b>37526341</b> W 120 cm	\$199.00
W 120 x D 60 x H 2 cm	

Desk Legs / Steel / Light Grey	
3 <b>15914555</b> W 150 x D 60 x H 72 cm*	\$139.00
4 <b>15914562</b> W 120 x D 60 x H 72 cm*	\$119.00

\*Dimensions when legs are combined with the top panel

Steel Cabinet / Light Grey	
5 <b>18121236</b>	\$339.00
W 39.5 x D 53.5 x H 62.5 cm (With handle)	



Partition For Desk / Light Grey	
6 <b>15914579</b>	\$89.00
W 86 x D 6.5 x H 34 cm (Height when partition is attached to desk: 31.5 cm)	



L-shaped Shelf For Desk (With Magnet) / Light Grey	
7 <b>15914586</b>	\$33.00
W 30 x D 12 x H 12 cm	

Compact Steel Cabinet	
<b>37792098</b>	\$309.00

W 33 x D 33 x H 51 cm  
Tabletop: W 32 x D 24 cm  
Space behind the tabletop: W 32 x D 8 x H 6 cm  
Inside dimensions of drawer: W 31 x D 23 x H 5 cm  
Inside dimensions of lower space: W 32 x D 32 x H 33.5 cm

MUJI storage products fit perfectly so that you can easily take out things you frequently use.



An ABS A4 Tray (P94) fits perfectly in the space above the drawer.

MUJI storage products for accessories fit perfectly inside the drawer making it easy to organise.

## Desks and Cabinets

Desks that make use of natural wood grain, ideal for working or studying. A cabinet that allows you to use space efficiently, as its topboard can be used.



\* Due to the nature of the material, oak may have a unique pattern called "tiger grain."

Natural Oak / Desk With Drawers	
1 <b>15874781</b> Oak	\$409.00
W 110 x D 55 x H 70 cm	
A desk made of laminated natural white oak grown in North America. Hooks can be attached either on the right side or left side of the desk.	



Natural Oak / Desk Cabinet / 2 Drawers	
2 <b>15874804</b> Oak	\$289.00
W 35 x D 48 x H 56 cm	
Top panel, front panel of drawer: laminated natural oak	
Side panel of body: oak veneer urethane resin coating	
Inside dimensions of drawer	
Top: W 25.5 x D 37.5 x H 6.5 cm	
Bottom: W 25.5 x D 37.5 x H 29.5 cm	
Withstand load: 10 kg for top panel, 3 kg for top drawer, 5 kg for bottom drawer	

## Working Chair

The office chair can be adjusted for a comfortable height regardless of how tall the user is. Arms are also available for an even greater comfortableness.



Working Chair	
1 <b>18121298</b> Grey	\$199.00
2 <b>18121304</b> Black	
W 55.5 x D 53 x H 74-84 (seat surface: 39-49) cm	
Outer shell: 100% polyester	
Frame: steel, polyester powder coating	

Working Chair / Arm Set	
<b>18121861</b> Grey	\$43.00
<b>18121878</b> Black	
When armrests are attached: W 57 x D 53 x H 74-84 cm	
Outer shell: 100% polyester	
Frame: steel, polyester powder coating	



When arms are attached

## Chairs

We have prepared chairs made of various materials and types of comfort to match any kind of table.



Oak / Cushioned Seat / Chair

1 **15892372** Cotton Plain Weave / Beige

\$249.00

## Beechwood

Compact furniture made using fine-grade beechwood produced in Europe has the shapes that are comfortable to the hands.



Beech / Compact Table

3 **15120109**

\$289.00

W 75 x D 40 x H 70 cm

This is a compact-sized table.



Beech / Low Table

4 **15902217** Round

\$209.00

W 59.5 x D 59.5 x H 35 cm

The height is perfect to use when sitting on the floor. An easy-assembly structure allows to take the product home.



Beech / Coatstand

5 **61013107**

\$99.00

W 48 x D 42 x H 173.5 cm

Withstand load: 15 kg

A three-legged coat hanger with a small footprint. This product can be carried home as it is designed to be assembled.

\* Please be sure to observe the withstand load. Make sure that children do not hang on this product.



## Good enough Living Column vol.4

Tables, Chairs & Desks

### Natural wood is our new furniture standard.



Natural Wooden Table Bench P115

Since 2014, MUJI has gradually added more and more pieces to our Natural Wood furniture series. Tough and durable, oak is the most common furniture wood in Europe and North America, and white oak tables and benches take on the distinctive qualities of this wood, as well.

MUJI uses white oak grown in Appalachia, where the lumber is especially suited to furniture. Enjoying a climate and calcic soil in which forests thrive, Appalachia has long been known for its high-quality oak.

This is a well-managed forest industry with a firmly established cycle of oak tree cultivation, logging, and natural growth. Maintaining and protecting this cycle is important in keeping forests healthy and ensuring there is no risk of harm to nature. MUJI visits these forests, secures reliable procurement channels, and gives consideration to environmental protection.

Natural wood furniture is more easily scratched than furniture with veneer finishes, and it changes colour over time. More and more, though, people are coming to value the quality of natural wood and to appreciate these gradual changes in their furniture. Maintaining natural wood as it changes over the years creates an even deeper connection with the furniture, encouraging long years of use. Because it tends to be thicker and heavier than furniture with veneer finishes, MUJI focuses on refined, well-balanced designs in sizes that are easy to use.

These pieces bring respect for nature and its value into the home and blend naturally into daily life. MUJI remains committed to this standard of craftsmanship.

“Furniture that ages well comes to be appreciated.”



## HOME DELIVERY

Delivery Time	Delivery charges for purchases below S\$500	Delivery charges for purchases above S\$500
<b>Monday - Friday</b>		
10:00am - 7:00pm	S\$40	Free
7:00pm - 9:00pm	S\$60	S\$20
<b>Saturday</b>		
10:00am - 6:00pm	S\$60	S\$20

No deliveries on Sunday and Public Holidays.  
 Labour charge for walk-up apartment is at S\$10 per level.  
 Delivery service is based on single destination within Singapore only.

No assembly charges will be required on the first delivery,  
 for subsequent request, assembly charge of \$8 per item will be applicable.

Stock availability and delivery charges vary for online and in-store.  
 Kindly visit our webpage ([www.muji.com.sg/store](http://www.muji.com.sg/store)) for more information.

Please approach our staff for further enquiries.

MUJI (SINGAPORE) Pte Ltd reserves the right to amend the above  
 Terms & Conditions without prior notice.



**MUJI**  
無印良品

[www.muji.com/sg/](http://www.muji.com/sg/)  
[www.facebook.com/muji.sg](https://www.facebook.com/muji.sg)  
[www.instagram.com/mujisg](https://www.instagram.com/mujisg)

313@somerset	#B2-38 to 41 & 47 to 49	Tel: 6634 5053
Bugis Junction	#03-10F	Tel: 6336 7885
ION Orchard	#B4-13 to 16	Tel: 6509 9321
Jem	#04-33 to 37	Tel: 6339 2558
Marina Square	#02-326 to 330	Tel: 6336 6123
Paragon	#04-36 to 40	Tel: 6735 0123
Plaza Singapura	#01-10 to 17	Tel: 6264 5838
Raffles City	#02-20/22	Tel: 6264 4189
Tampines 1	#03-07	Tel: 6509 9733
VivoCity	#02-198	Tel: 6376 8023
Changi Airport T2	#026-024-01, Departure	Tel: 6546 6421