

# MUJI

## 無印良品

### Wall-mounted CD Player

Model CPD-4

# USER MANUAL

壁掛式CD音響

型號 CPD-4

## 操作說明書



- Thank you for purchasing this product.
- Be sure to read this user manual before operating the product and use it correctly.
- Store this manual in a safe place for future reference.

- 多謝惠顧本公司產品。
- 為了正確及安全地使用本產品，使用前請詳細參閱此說明書。
- 請務必妥善保管本操作說明書。

COMPACT  
disc  
DIGITAL AUDIO

ENGLISH

繁體中文

	<b>CAUTION</b> RISK OF ELECTRIC SHOCK DO NOT OPEN	
CAUTION: TO REDUCE THE RISK OF ELECTRIC SHOCK, DO NOT REMOVE COVER (OR BACK). NO USER-SERVICEABLE PARTS INSIDE. REFER SERVICING TO QUALIFIED SERVICE PERSONNEL.		



The lightning flash with arrowhead symbol, within an equilateral triangle, is intended to alert the user to the presence of uninsulated “dangerous voltage” within the product’s enclosure that may be of sufficient magnitude to constitute a risk of electric shock to persons.



The exclamation point within an equilateral triangle is intended to alert the user to the presence of important operating and maintenance (servicing) instructions in the literature accompanying the appliance.

## IMPORTANT SAFETY INSTRUCTIONS

- 1) Read these instructions.
- 2) Keep these instructions.
- 3) Heed all warnings.
- 4) Follow all instructions.
- 5) Do not use this apparatus near water.
- 6) Clean only with dry cloth.
- 7) Do not block any ventilation openings. Install in accordance with the manufacturer’s instructions.
- 8) Do not install near any heat sources such as radiators, heat registers, stoves, or other apparatus (including amplifiers) that produce heat.
- 9) Do not defeat the safety purpose of the polarized or grounding-type plug. A polarized plug has two blades with one wider than the other. A grounding type

plug has two blades and a third grounding prong. The wide blade or the third prong are provided for your safety. If the provided plug does not fit into your outlet, consult an electrician for replacement of the obsolete outlet.

- 10) Protect the power cord from being walked on or pinched particularly at plugs, convenience receptacles, and the point where they exit from the apparatus.
- 11) Only use attachments/accessories specified by the manufacturer.
- 12) Use only with the cart, stand, tripod, bracket, or table specified by the manufacturer, or sold with the apparatus. When a cart is used, use caution when moving the cart/apparatus combination to avoid injury from tip-over.
- 13) Unplug this apparatus during lightning storms or when unused for long periods of time.
- 14) Refer all servicing to qualified service personnel. Servicing is required when the apparatus has been damaged in any way, such as power-supply cord or plug is damaged, liquid has been spilled or objects have fallen into the apparatus, the apparatus has been exposed to rain or moisture, does not operate normally, or has been dropped.



- Do not expose this apparatus to drips or splashes.
- Do not place any objects filled with liquids, such as vases, on the apparatus.
- Do not install this apparatus in a confined space such as a book case or similar unit.
- The apparatus draws nominal non-operating power from the AC outlet.
- The apparatus should be located close enough to the AC outlet so that you can easily grasp the power cord plug at any time.
- The appliance coupler is used as the disconnect device, the disconnect device shall remain readily operable.
- If the product uses batteries (including a battery pack or installed batteries), they should not be exposed to sunshine, fire or excessive heat.
- CAUTION for products that use replaceable lithium batteries: there is danger of explosion if a battery is replaced with an incorrect type of battery. Replace only with the same or equivalent type.

**WARNING: TO PREVENT FIRE OR SHOCK HAZARD, DO NOT EXPOSE THIS APPLIANCE TO RAIN OR MOISTURE.**

#### **CAUTION**

- DO NOT REMOVE THE EXTERNAL CASES OR CABINETS TO EXPOSE THE ELECTRONICS. NO USER SERVICEABLE PARTS ARE WITHIN.
- IF YOU ARE EXPERIENCING PROBLEMS WITH THIS PRODUCT, CONTACT MUJI LIMITED FOR A SERVICE REFERRAL. DO NOT USE THE PRODUCT UNTIL IT HAS BEEN REPAIRED.
- USE OF CONTROLS OR ADJUSTMENTS OR PERFORMANCE OF PROCEDURES OTHER THAN THOSE SPECIFIED HEREIN MAY RESULT IN HAZARDOUS RADIATION EXPOSURE.

---

MPEG Layer-3 audio coding technology licensed from Fraunhofer IIS and Thomson.

This product is protected by certain intellectual property rights of Microsoft. Use or distribution of such technology outside of this product is prohibited without a license from Microsoft.

Other company names, product names and logos in this document are the trademarks or registered trademarks of their respective owners.

# Contents

Before Using the Unit . . . . .	4
Safety Precautions . . . . .	6
Discs . . . . .	11
MP3/WMA Compatibility . . . . .	12
Identifying the Parts . . . . .	13
Remote Control Unit . . . . .	14
Installation Method . . . . .	14
Connecting the AC adaptor . . . . .	15
Listening to a Disc . . . . .	16
Listening to the Radio . . . . .	18
Troubleshooting . . . . .	19
Specifications . . . . .	21

# Before Using the Unit

## What's in the box

Confirm the supplied standard accessories.

### Remote control unit x 1

#### Battery (CR2025) for remote control unit x 1

(The battery has been installed in the remote control unit when shipped from the factory.)

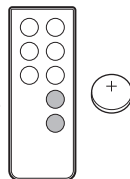

### Wall-fixing plate x 1

#### Fixing screws x 4

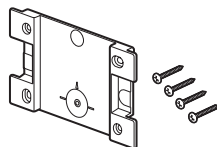

### Dedicated AC adaptor x 1

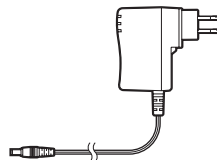

### Owner's manual (this document) x 1

## AC adaptor's plug

Please change the AC adaptor plug to suit the mains socket where you will use the unit.

1. While pulling the tab at the side of the AC adaptor plug, pull the plug out at an angle to remove it.

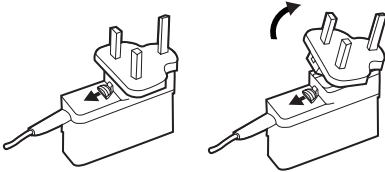

2. Attach the concave part of the plug (A) to the convex part (B) on the inside opposite the tab.

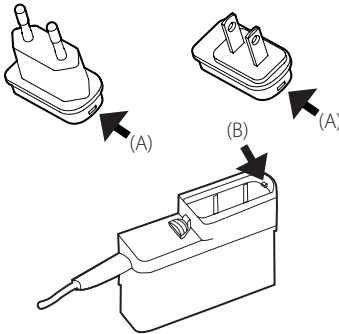

3. Insert the plug until you hear a click.

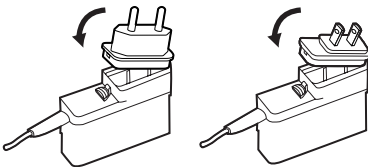



## Read this before operation

- When a disc is inserted into the unit, do not tilt the unit. Doing so might cause a malfunction.
- Before the unit is moved, or covered with a paper or cloth for a moving, be sure to remove the disc from the unit. If the unit is moved with a disc inside, it might cause a malfunction.
- Choose the installation location of your unit carefully. Avoid placing it in direct sunlight or close to a source of heat. You should also avoid locations that are subject to vibration, excessive dust, heat, cold, or moisture. Doing so might result in discoloration or deformation, or cause a malfunction.
- When the unit is turned on, if a TV is turned on nearby lines might appear on the TV screen depending on the frequency of the TV broadcast. This is not a malfunction of the unit or the TV. If you see such lines, turn off the unit (standby), or remove the plug of the AC adaptor from the socket.
- While the plug of the AC adaptor is inserted into the socket, power is consumed even in stand-by mode.

# Safety Precautions

In order to use the product safely and correctly, and to prevent both injury to yourself and others around you and damage to property, please read the following safety precautions carefully before use.

 <b>Warning</b>		<p><b>If you ignore the following warnings and use the product incorrectly, it may cause death or serious injury due to fire or electrocution.</b></p>
 <p><b>Disconnect at plug</b></p>	<p><b>If anything unusual occurs</b>  <b>If smoke, a strange smell, or a strange noise is emitted from the product</b>  <b>If water or foreign bodies get into the product</b>  <b>If the product falls and becomes damaged</b></p> <p>You must remove the plug of the AC adaptor from the power socket immediately.          Do not continue to use the product as this may cause a fire or electric shock. Contact your retailer.</p>	
	<p><b>Before installing and removing this product, always ensure you remove the plug of the AC adaptor from the power socket.</b></p> <p>If the plug of the AC adaptor is still inserted into the power socket, there is a risk of accident or electrocution.</p>	
	<p><b>Before moving this product, always remove the plug of the AC adaptor from the power socket.</b></p> <p>The cable of the AC adaptor may be damaged, and it may cause a fire or electric shock.</p>	
	<p><b>If you do not use the product for an extended period of time, for example, if you are going away on vacation, the plug of the AC adaptor must be removed from the power socket for safety reasons.</b></p>	
	<p><b>Remove the plug of the AC adaptor from the power socket for safety reasons before maintenance.</b></p> <p>Otherwise, it may cause electrocution.</p>	
 <p><b>Prohibited</b></p>	<p><b>Do not damage the DC power cable and AC adaptor cable.</b>  <b>Do not place anything heavy on the DC power cable and AC adaptor cable, or place the DC power cable and AC adaptor cable under the product.</b>  <b>Do not alter, bend excessively, twist, pull, or heat the DC power cable and AC adaptor cable and AC adaptor cable.</b></p> <p>If the DC power cable or AC adaptor cable is damaged (the core is exposed or broken), it may cause a fire or electric shock. In such a case, ask your retailer to exchange it.</p>	



## Warning

If you ignore the following warnings and use the product incorrectly, it may cause death or serious injury due to fire or electrocution.



Prohibited

**Keep the plug of the AC adaptor free from dust.**

If there is dirt or dust between the plug of the AC adaptor and the power socket, it may cause a fire or electric shock. Remove dirt or dust after removing the plug of the AC adaptor from the power socket.

**Do not use the product with any voltage other than that indicated on the AC adaptor.**

This product is for use within the country of purchase only. It cannot be used in other countries. Do not use the product with any power supply or voltage other than that indicated on the AC adaptor. Do not connect the AC adaptor to DC power supplies of on ships, etc. Doing so may cause a fire or electric shock.

**Do not use any AC adaptor other than that supplied with this product.**

**Do not use the AC adaptor supplied with this product for another equipment.**

Doing so may cause a malfunction, fire, or electric shock.

**Do not leave the DC power cable near any heat sources such as stoves or other objects that produce heat.**

The cover of the DC power cable may be melted and it may cause a fire or electric shock.

**Do not touch the plug of the AC adaptor with wet hands.**

Doing so may result in electrocution.





**Do not pull on the AC adaptor cable when you remove the plug of the AC adaptor from the power socket.**

The AC adaptor cable may be damaged, and it may cause a fire or electric shock. Be sure to grasp the plug of the AC adaptor when removing it from the power socket.

**Do not place vases or anything containing water or other liquids on the product.**

If water gets into the product, it may cause a fire or electric shock.

# Safety Precautions (Continued)

	<b>Warning</b> If you ignore the following warnings and use the product incorrectly, it may cause death or serious injury due to fire or electrocution.
	<b>Do not locate the product in a place that is either damp or dusty. Do not use the product in a bathroom.</b> <b>Do not locate the product in a place where it may be exposed to smoke or steam, such as near a kitchen table or humidifier.</b> Doing so may result in a fire, electric shock, or injury.
	<b>Do not take this product apart.</b> Doing so may cause a fire or electric shock. Ask the retailer for servicing/repairs of the inside.
<b>No disassembly</b>	<b>Do not alter this product.</b> Doing so may cause a fire or electric shock.
	<b>The product should be located close to the power socket so that you can easily grasp the plug of the AC adaptor at any time.</b> If anything unusual occurs, you must remove the plug of the AC adaptor from the power socket immediately.
<b>Mandatory Action</b>	<b>The product should be located away from another equipment in order to be able to expel heat.</b> <b>When the product is installed in a rack or similar unit, leave a space of at least 5 cm (2 inches) above the product.</b> Heat is generated inside the product, and may cause a fire if not expelled properly.



**Caution**

If you ignore the following cautions and use the product incorrectly, it may cause injury to yourself and others around you and damage to property due to electrocution or other accidents.

**Precaution  
Against fall**

**When installing this product, refer to the installation method in this manual at all times, taking care to observe the following.**

When attaching the wall-fixing plate, make sure that you use screw fixings that are appropriate for the structure and material of the wall. The product may cause injury in the event that it falls from the wall.

**Prohibited**

**Do not place the product on an unstable or uneven place.**

The product may cause injury in the event that it falls from the wall.





**Do not move the product during playback.**

Do not pick up or move the product since the disc spins very quickly during playback. Doing so may cause scratches on the disc.

# Safety Precautions (Continued)

## Battery Precautions

This product uses a battery. If you handle the battery incorrectly, it may result in the battery heating up, catching fire, or leaking. Be sure to observe the following precautions.

 <b>Warning</b> Warnings for battery usage	
 <b>Mandatory Action</b>	<p><b>When inserting the battery into the remote control unit, check that the polarities (positive “+” and negative “-”) are correctly positioned, and insert it according to the indication on the battery case.</b></p> <p>If you insert the battery incorrectly, it may cause a fire or injury, or staining of surrounding objects due to explosion or leaking.</p>
	<p><b>If the remote control unit is not used for a long time, remove the battery.</b></p> <p>Battery leakage may cause a fire or injury, or staining of surrounding objects. If the battery leaks, wipe away the leakage inside the battery compartment and replace the battery with a new one. If the leakage adheres to your skin, wash it with water.</p>
 <b>Prohibited</b>	<p><b>Do not use any batteries other than those specified for the remote control unit.</b></p> <p>Otherwise, it may cause a fire or injury, or staining of surrounding objects due to explosion or leaking.</p>
	<p><b>Do not carry or store the battery with other metallic objects.</b></p> <p>The battery may short circuit, which may cause it to explode or leak, etc.</p>
 <b>No disassembly</b>	<p><b>Do not take the battery apart.</b></p> <p>Acidic matter inside the battery may cause damage to your skin or clothes.</p>

# Discs

## Discs that can be played on this unit

CDs that bear the "COMPACT disc DIGITAL AUDIO" logo.



CD-R and CD-RW discs that have been correctly recorded in the audio CD format and finalized.  
Finalized CD-R and CD-RW discs that contain MP3/WMA files.

This unit can play back the above-mentioned disc types. It cannot play back the discs of the other types.

### Caution:

**Playback of any other type of disc could cause loud noise and damage to speakers as well as harm hearing. Never play back any other type of disc.**

- Copy-protected discs and other discs that do not conform to the CD standard might not play correctly in this unit. If you use such discs in this unit, MUJI LIMITED and its subsidiaries will not be responsible for any consequences or guarantee the quality of reproduction. If you experience problems with such non-standard discs, you should contact their issuers.

## About CD-R/CD-RW discs

This unit can play back CD-R and CD-RW discs that have been recorded in the audio CD format (CD-DA). Also can playback MP3 and WMA files recorded into the CD-R/CD-RW discs.

- Discs created by a CD recorder must be finalized before use with this unit.
- Depending on disc quality and recording conditions, playback of some discs might not be possible. Please see the manual for the device that you used to create the disc.

- If you are uncertain about the handling of a CD-R or CD-RW disc, please contact the seller of the disc directly.

## Caution

- Do not play any disc that is warped, deformed or damaged. Playing such discs could cause irreparable harm to the playing mechanisms.
- Use a soft oil-based felt-tipped pen to write information on the label side. Never use a ball-point or hard-tipped pen, as this could cause damage to the recorded side.
- Never use a stabilizer. Using commercially available CD stabilizers with this unit will damage the mechanisms and cause them to malfunction.
- Do not use irregularly-shaped discs (octagonal, heart-shaped, business card size, etc.). CDs with these shapes could damage the unit.

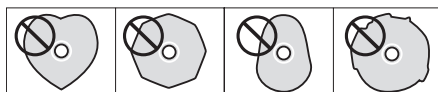

## Handling precautions

- Always insert a disc with the label side up. Only one side of a Compact Disc can be played.
- If there are scratches, fingerprints, or stains on the recorded side (non-label side), an error may occur when attempting to play back a disc. Handle the disc carefully.
- To remove a disc from its storage case, press down on the center of the case and lift the disc out, holding it carefully by the edges.



How to remove the disc



How to hold the disc

# Discs (Continued)

---

## Storage precautions

- Discs should be returned to their cases after use to avoid dust and scratches that could cause the laser pickup to "skip."
- Do not expose discs to direct sunlight or high-temperature and humidity for extended periods. Long exposure to high temperatures will warp discs.
- CD-R and CD-RW discs are more sensitive to the effects of heat and ultraviolet rays than ordinary CDs. It is important that they are not stored in locations where they will be exposed to direct sunlight. They should also be kept away from sources of heat, such as radiators and heat-generating electrical devices.
- Dirt on the disc may cause the sound to skip or reduce the sound quality. Be sure to keep the discs clean.

## Maintenance

- If a disc becomes dirty, wipe its surface radially from the center hole outward towards the outer edge with a soft, dry cloth.



- Never clean discs using chemicals such as record sprays, antistatic sprays and fluids, and thinner. Such chemicals will do irreparable damage to the disc's plastic surface.

# MP3/WMA Compatibility

---

This unit can play MP3/WMA files recorded on a CD-R, CD-RW discs.

- This unit can play back monaural and stereo MP3 files that are in the MPEG-1 Audio Layer 3 format with a sampling rate of 16 kHz or 48 kHz and a bit rate of 32 to 320 kbps.
- WMA file must have a sampling rate of 32 kHz, 44.1 kHz or 48 kHz, and a bit-rate of 48 to 192 kbps.
- This unit cannot play copyright protected files.

## Cautions when preparing MP3/WMA files using a computer or other device

- Always include the extension in the file name. This unit recognizes MP3 files by their ".mp3", and WMA files by their ".wma" file extensions.
- Always close the session (complete disc creation). This unit cannot play discs if the session has not been closed.
- If the disc contains more than 999 files or 99 folders, this unit cannot play it back correctly.

# Identifying the Parts

## Main unit

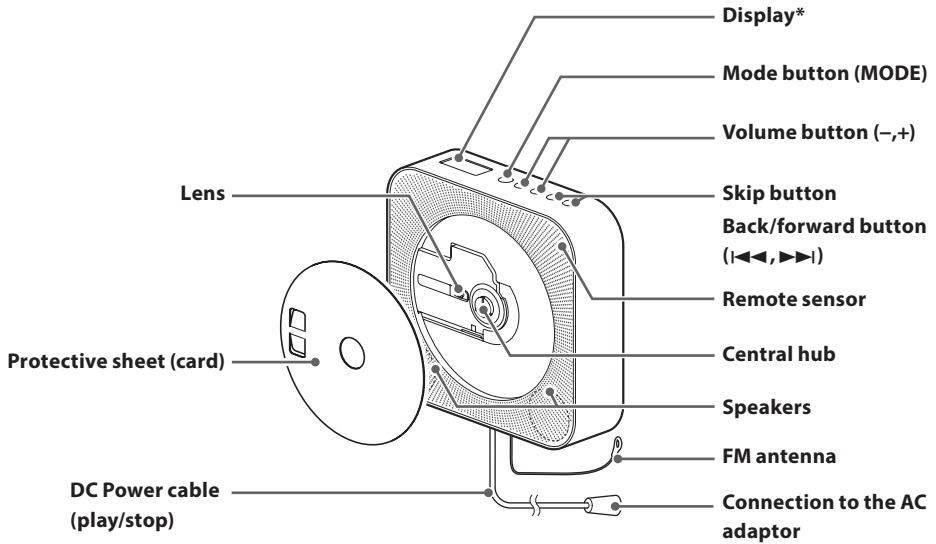

## Remote control unit

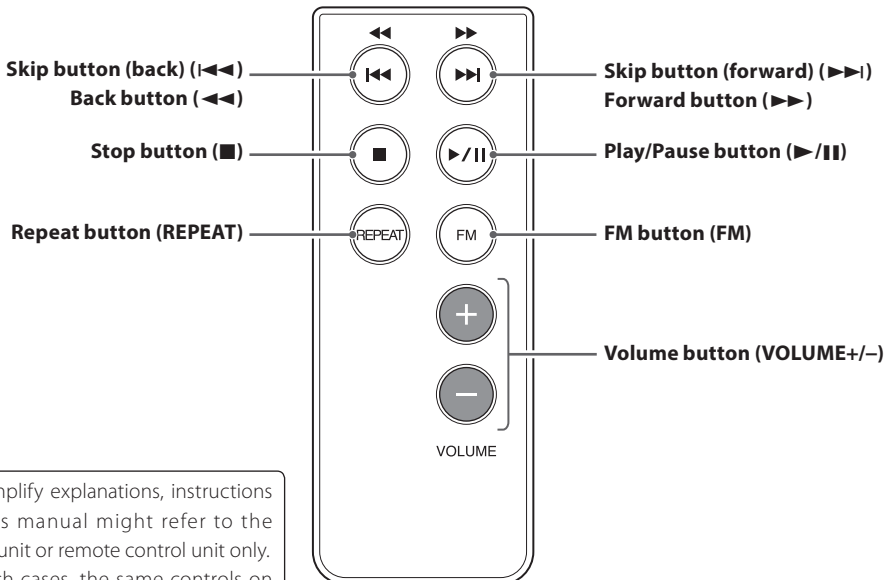

To simplify explanations, instructions in this manual might refer to the main unit or remote control unit only. In such cases, the same controls on the remote control and main unit will operate similarly.

# Remote Control Unit

## Notes on using the remote control unit

- Even if the remote control is used within its effective operation range (5 m/16 feet), the unit might not respond to the remote if there are any obstacles between them.
- The remote control might not function if sunlight or other bright light shines directly on the remote sensor of the unit.
- The remote control might function incorrectly if it is operated near other products that generate infrared rays or if other remote control devices that use infrared rays are operated near the unit. Likewise, the other products might also function incorrectly.

## Before using the remote control

When you use the remote control for the first time, pull out the insulation sheet from the rear.



## Battery replacement

The battery has been installed in the remote control unit when shipped from the factory.

To replace the battery, pull out the battery tray from the rear, put the lithium-ion battery (CR2025) in with the "+" side facing up, and insert the tray again.

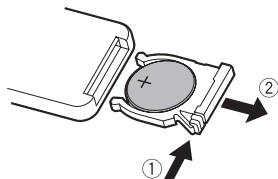

## Battery replacement time

If the distance required between the remote control unit and main unit decreases, or the remote control unit's buttons don't work, the battery is exhausted. In this case, replace the battery with a new one.

For information about the collection of batteries, please contact your local municipality, your waste disposal service or the place where you purchased them.

# Installation Method

## 1 Attach the wall-fixing plate to the wall.

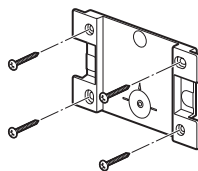

Choose a sturdy wall, and install the wall-fixing plate using the supplied screws or other fixings.

- Make sure that the wall-fixing plate does not feel shaky or loose.

## ⚠ Caution

Be very careful when attaching the wall-fixing plate to the wall.

- When attaching to walls made of plasterboard or concrete construction etc. please make sure that you use proprietary fixings that are appropriate for the wall. In particular, it is very hazardous to use regular wood screws on walls that are made of plasterboard or a similar type of material.

## 2 Extend the FM antenna.

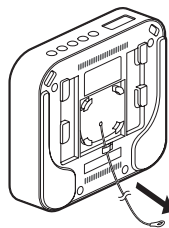

Unwind the FM antenna on the rear, and extend it.

### 3 Attach the unit to the wall-fixing plate.

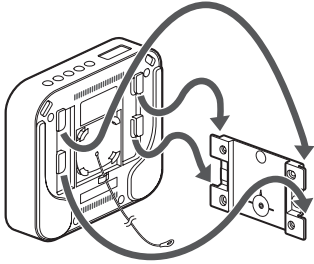

Line the unit up with the wall-fixing plate and clip the back of the unit on at the slots.

- Make sure that the unit is firmly attached.
- Extend the FM antenna fully and position for the best reception.

## Connecting the AC adaptor

After connecting the power cord to the dedicated AC adaptor cord, plug the adaptor into an outlet.

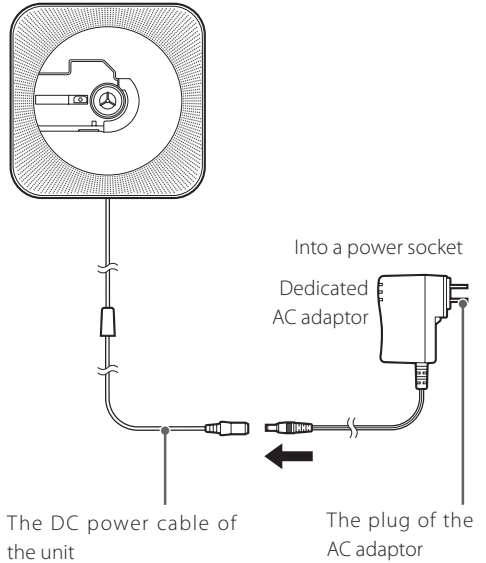

# Listening to a Disc

## 1 Insert the CD into the unit.

Fix the CD onto the central hub of the unit.

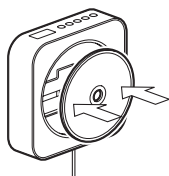

### ⚠ Caution

Fix the CD firmly into the unit until you hear a click. The CD will spin very fast, so it is extremely hazardous if the CD is not inserted correctly into the unit.

- Be careful not to press the CD too hard when you fix it. Doing so may cause scratches on the CD.

## 2 Gently pull the DC power cable to play back the CD.

CD playback will start automatically.

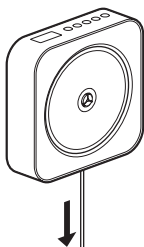

- The play/pause button (▶/||) on the remote control unit can also be used.
- Please do not touch the CD whilst it is spinning/playing.

## 3 Press the volume buttons (-,+), to adjust the volume.

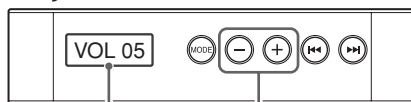

The volume level is shown.



- The volume can be adjusted in a range between 00 and 32. ("MAX" is shown on the display at 32.)

## To stop the playback, gently pull the DC power cable again.

- The stop button (■) on the remote control unit can also be used.
- 30 minutes after playback finishes, the machine will automatically enter stand-by mode. To re-activate from stand-by mode, pull on the power cable lightly.

## Removing the CD

Pull the CD straight outwards to remove it.



- Be careful not to press the CD too hard when you remove it. Doing so may cause scratches on the CD.

### Caution

Never touch the lens.

Please take care, as any damage or dirt can cause the CD player to malfunction.



## Selecting tracks

### To previous track

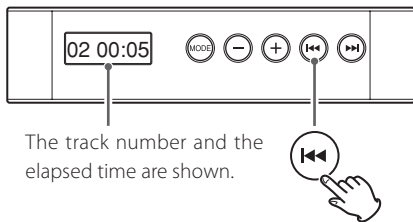

The track number and the elapsed time are shown.

- During playback, press the skip button (⏮) repeatedly to return to the previous tracks.
- During playback, press the skip button (⏮) once to return to the start of the current track.
- During playback, keeping the skip button (⏮) held down will take you back more quickly.

### To next track

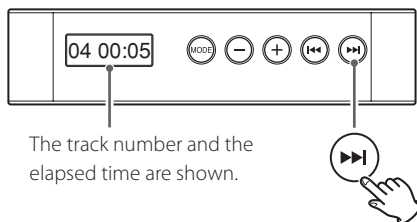

The track number and the elapsed time are shown.

- During playback, press the skip button (⏭) repeatedly to go to the next tracks.
- During playback, press the skip button (⏭) once to go to the start of the next track.
- During playback, keeping the skip button (⏭) held down will take you ahead more quickly.

## Playing back all tracks repeatedly

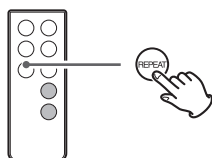

- During playback, press the repeat button (REPEAT) once to play back all tracks on the disc repeatedly from the first track ("REPEAT" is shown on the display).
- To stop the repeat playback, press the repeat button (REPEAT) again ("NORMAL" is shown on the display).

## MP3/WMA Playback Order

MP3/WMA files on a CD can be stored in folders in the same way that files are managed on a computer. Moreover, multiple folders can be contained inside another folder.

Here is an example of the file and folder structure of an MP3/WMA disc, showing the order of the folders and the playback order of the files (1 to 7).

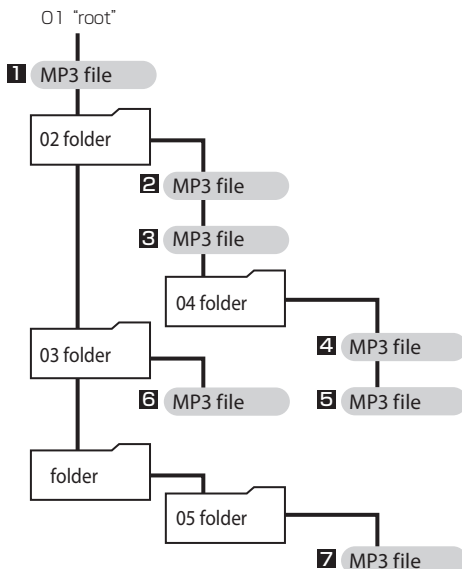

- The playback order shown in the diagram above may change depending on how you add, delete, or move files or folders.

# Listening to the Radio

## 1 Press the Mode button (MODE).

The source changes to FM.

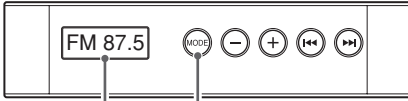

The frequency is shown after "FM" is shown.



- The FM button (FM) on the remote control unit can also be used.
- When a CD is not inserted into the unit, pulling the DC power cable will also perform the same operation.

## 2 Select the station you want to listen to.

Automatic selection

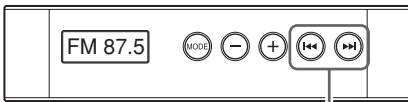

Hold down

Hold the skip button (◀◀/▶▶) for more than 2 seconds and release it when the frequency display starts changing continuously.

A station is tuned in automatically, and the frequency display will stop. Repeat this step until the station you want to listen to is found.

- To stop the automatic tuning process, press the skip button (◀◀/▶▶) briefly.

## Manual selection

To tune in to a station the unit cannot tune in to automatically, press the skip button (◀◀/▶▶) repeatedly to select the station you want to listen to.

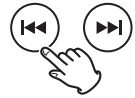
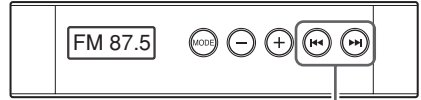

- Press the skip button (◀◀/▶▶) briefly. The frequency changes by a fixed step (0.1MHz). Press repeatedly until the station you want to listen to is tuned in.
- You can also use the skip buttons (◀◀/▶▶) on the remote control.

## 3 Press the volume buttons (-,+ ) to adjust the volume.

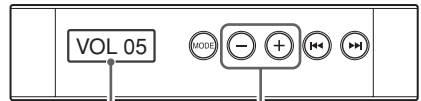

The volume level is shown.

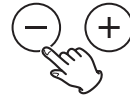

- The volume can be adjusted in a range between 00 and 32. ("MAX" is shown on the display at 32.)

# Troubleshooting

## If the reception is poor

Extend the FM antenna or change its position to improve the reception of a station.

## To turn off the unit (standby), press the Mode button (MODE) again.

- The FM button (FM) on the remote control unit can also be used.
- When a CD is not inserted into the unit, pulling the DC power cable will also turn off the unit (standby).

If you have a problem with your system, read this page and try to solve the problem yourself before calling your dealer.

### General

#### No power.

- ➔ Insert the plug of the AC adaptor into a power socket.
- ➔ Check the connection of the DC power cable and the AC adaptor cable.
- ➔ If the battery of the remote control unit is exhausted, replace it with a new one.

#### I'm pressing the buttons but nothing is working.

- ➔ Condensation. Wait one hour before using.

#### No sound is coming from the speakers.

- ➔ The volume is turned down. Adjust the volume.

#### The remote control does not work.

- ➔ The insulation sheet has been inserted in the battery compartment when shipped from the factory. Pull it out before use. For details, see page 14.
- ➔ If the battery is exhausted, replace it with a new one.
- ➔ Use the remote control unit within the operation range (5 m/16 feet) and point it at the remote sensor on the main unit.
- ➔ Remove obstacles between the remote control unit and the main unit.
- ➔ If a bright light is near the unit, turn it off.

#### The sound is noisy.

- ➔ The unit is too close to a TV or similar device. Relocate it away from the interfering device or turn it off.

# Troubleshooting (Continued)

---

## CD player

### Cannot insert the CD into the unit.

- ➔ Remove dust or obstacles from the central hub of the unit.

### Cannot play.

- ➔ Insert a disc with the label side facing you.
- ➔ You cannot play back unfinalized CD-R/RW discs. Finalize such a disc using a CD recorder and try again.
- ➔ Depending on the disc type, it may not be possible to play back. For details, see pages 11 and 12.

### The sound stutters or breaks up.

- ➔ The unit is placed somewhere where there is a lot of vibration. Put it somewhere with less vibration.
- ➔ The disc is dirty. Clean the disc.

## MP3/WMA

### Cannot play.

- ➔ Check the MP3/WMA file extension. For details about the extension, see page 12.

## FM Tuner

### Cannot listen to any station, or the signal is too weak.

- ➔ Tune in to a station properly.
- ➔ Change the position or orientation of the main unit until you receive the station clearly.
- ➔ Rotate the FM antenna until you receive the station clearly.

A microcomputer is used in this unit, it may sometimes not operate correctly due to noise, etc. from around the unit. In this case, remove the plug of the AC adaptor from the power socket, wait for a while before inserting the plug back into the power socket, then operate the unit again.

### Maintenance

If the main unit or remote control unit gets dirty, wipe with a soft cloth or use a diluted, mild, liquid soap. Do not use benzine or thinner as they could damage the surface of the unit.



### Caution

**Remove the plug of the AC adaptor from the power socket before maintenance.**

# Specifications

## CD Player

Playable disc types . . . . . CD/CD-R/CD-RW (8cm/12cm)  
Playable formats . . . . . CD-DA, MP3/WMA file  
Pickup  
    Non-contact optical pickup/semiconductor laser  
Sampling frequency . . . . . 44.1kHz  
Frequency characteristic . . . . . 20Hz to 20kHz  
Wow and flutter . . . . . Below limited measurable quantity

## TUNER

FM Frequency Range . . . . . 87.5 MHz to 108.0 MHz

## Playback formats (MP3/WMA)

### MP3

Compatible format . . . . . MPEG-1/2 Audio Layer-3  
Extension . . . . . mp3  
Sampling frequency . . . . . 16kHz to 48kHz  
Bit rate . . . . . 32kbps to 320kbps

### WMA

Compatible format  
    Windows Media Audio Standard  
    (not copyright protected files)  
Extension . . . . . wma  
Sampling frequency . . . . . 32kHz, 44.1kHz, 48kHz  
Bit rate . . . . . 48kbps to 192kbps  
Maximum number of folders . . . . . 99  
Maximum number of files (each folder) . . . . . 99

## Speakers

Speaker unit . . . . . 3.5cm full range speaker × 2  
Rated impedance . . . . . 4Ω

## Amp

Rated output . . . . . 2W × 2  
Frequency characteristic . . . . . 50Hz to 20kHz

## General

Supply voltage/power . . . . . AC 100 - 240V, 50 / 60Hz  
Power dissipation . . . . . 12W  
Maximum outer dimensions (Main unit)  
    W=172mm H=172mm D=41mm  
Weight (excluding the AC adaptor) . . . . . 550g

## Accessories

Remote control unit × 1  
Battery (CR2025) for remote control unit × 1  
    The battery has been installed in the remote control when shipped from the factory.  
Wall-fixing plate × 1  
Fixing screws × 4  
Dedicated AC adaptor × 1  
Owner's manual (this document) × 1

- Design and specifications are subject to change without notice.
- Illustrations may differ slightly from production models.

# 目 錄

使用之前.....	22
安全使用事項.....	24
光碟.....	28
MP3/WMA.....	29
遙控器的使用方法.....	30
安裝方式.....	30
連接交流電源變壓器.....	31
各部位名稱.....	32
聆聽CD.....	33
收聽廣播.....	35
處理故障.....	36
規 格.....	37

# 使用之前

## 確認附件

萬一附件不全或存在損壞，請聯繫您購買的商店。

遙控器 × 1  
遙控器用鈕扣型鋰電池  
(CR2025) × 1  
(出廠時已裝入遙控器)

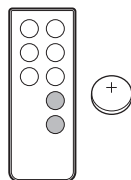

壁掛板 × 1  
安裝螺絲 × 4

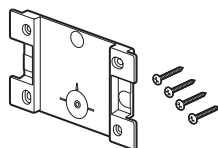

專用交流電源變壓器 × 1

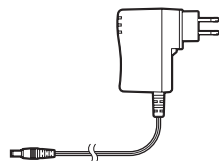

操作說明書 (本書) × 1

## 交流電源變壓器的插頭

請更換交流電源變壓器插頭以適應本機所用的電源插座。

1. 拉動交流電源變壓器側面的拉扣，將插頭斜向取出。

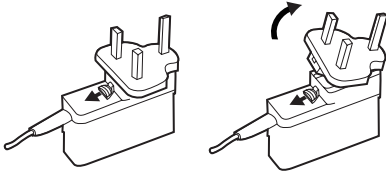

2. 將插頭的凹部 (A) 與拉扣對面的凸部 (B) 相掛扣。

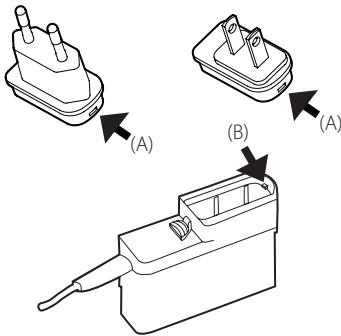

3. 插頭插入，直到聽到咔嗒聲。

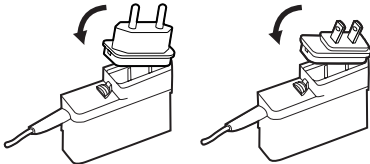



## 使用注意事項

- 裝有光碟時，請勿傾斜本機。否則可能導致故障。
- 移動本機或因搬家等原因而裝箱前，請務必取出光碟。在裝有光碟的狀態下移動，可能導致故障。
- 請勿將本機放置於溫度會升高的位置（如陽光直射的位置或暖氣設備的旁邊）。此外，請勿將本機放置於擴音器等會發熱的設備上方。否則可能導致變色、變形或發生故障。
- 根據電視播放的電波狀態，如果在本機使用過程中打開電視，畫面可能出現條紋，這並非本機或電視的故障。此時，請將本機調到待機狀態，或從插座上拔下交流電源變壓器。
- 在電源插頭插入插座的狀態下，本機將消耗待機所需的電力。

# 安全使用事項

為了安全地使用本產品，並對您和他人的人身傷害及財產損失防患於未然，請熟讀以下注意事項。

<b>警告</b> 如果無視以下內容而錯誤操作，可能會因火災、觸電等原因導致死亡、重傷等人身事故。	
	<b>萬一出現異常</b> 冒煙或發出奇怪的聲音時。 異物或水進入本品內部時。 本產品掉落、破損時。 請立即從插座上拔下電源插頭。 如果在異常狀態下繼續使用，可能導致火災或觸電。此時，請委託銷售商店進行修理。
	安裝或拆除本產品時，請務必從插座上拔下電源插頭。 在電源插頭連接至插座的狀態下進行操作，可能導致觸電或發生故障。
	移動本產品時，請務必從插座上拔下電源插頭。 否則可能導致電線受損，引起火災或觸電。
	由於旅行等原因長期不用本產品時，為了安全起見，請務必從插座上拔下電源插頭。
	進行保養時，為了安全起見，請從插座上拔下電源插頭。 否則可能導致觸電。
	切勿損壞電源線。 切勿用重物壓住電源線，或將電源線壓到本產品的下方。 切勿加工、勉強彎曲、扭曲、拉扯或加熱電源線。 如果電源線破損，可能導致火災或觸電。萬一電源線出現損壞（芯線外露或斷線等），請委託銷售商店進行更換。



# 警告

如果無視以下內容錯誤操作，可能會因火災、觸電等原因導致死亡、重傷等人身事故。



**電源插頭不可積有灰塵。**

如果電源插頭與插座之間有雜質或灰塵附著，可能導致火災或觸電。請從插座上拔下電源插頭，然後清除雜質或灰塵。

**切勿使用交流電源變壓器未標註的電壓。**

本產品祇能在國內使用。不可使用交流電源變壓器未標注的電源電壓。請勿與船舶等的直流（DC）電源連接。否則可能導致火災或觸電。

**切勿使用非本產品附帶的交流電源變壓器。**

**切勿將本產品附帶的交流電源變壓器用於其他設備。**

否則可能導致故障、火災或觸電。

**電源線不可靠近加熱器具。**

如果電源線的外層被溶化，可能導致火災或觸電。

**切勿用濕手插拔電源插頭。**

否則可能導致觸電。

**拔下電源插頭時，切勿拉扯電源線。**

否則可能導致電線受損，引起火災或觸電。請務必握住插頭，將其拔下。

**切勿在本產品上方放置花瓶或盛水的容器。**



如果水進入本產品內部，可能導致火災或觸電。



**切勿將本產品置於潮濕多塵的場所。切勿在浴缸附近及淋浴室內使用本產品。**

**切勿將本產品放置於接觸油煙、水氣的場所（如烹飪枱、加濕器的旁邊等）。**

否則可能導致火災、觸電及人員受傷。

## 安全使用事項（續）

<b>警告</b> 如果無視以下內容而錯誤操作，可能因火災、觸電等原因導致死亡、重傷等人身事故。	
	切勿拆解本產品。 擅自拆解可能導致火災或觸電。產品內部的檢修請委託銷售商店。
	切勿改裝本產品。 否則可能導致火災或觸電。
	本產品的安裝應靠近插座，並確保能輕鬆觸及電源插頭。 如果出現異常，請立即從插座上拔下電源插頭。
	安裝本產品時，為了保持良好的散熱，應與其他設備保持適當的距離。 將本產品放在置物架等處時，產品上方應保留5cm以上的間隙。 否則，熱量積聚於產品內部，可能導致火災。



<b>注意</b> 如果無視以下內容而錯誤操作，可能因觸電或其他事故，導致受傷或損壞周邊的家庭財產。	
	安裝本產品時，請務必通過本說明書確認安裝方法，並注意以下事項。 安裝壁掛板請使用適合牆壁材質和結構的安裝螺絲。否則，可能因本產品掉落而導致人員受傷。
	切勿將本產品放置在鬆動的枱面或傾斜的、不穩定的位置上。 否則，可能因本產品掉落導致受傷。
	在播放時切勿移動本產品。 光碟在播放時高速旋轉，因此請勿提起或移動本產品。否則可能損壞光碟。

## 電池的操作

本產品使用電池。錯誤操作可能導致發熱、起火或漏液，因此請務必遵守以下注意事項。

### 警告

#### 關於電池的警告事項

	<p>將電池放入遙控器時，請注意電池的正負極標示（正極 ⊕ 和負極 ⊖ 的朝向），按照電池盒的標示將電池正確放入。</p> <p>錯置正負極可能導致電池破裂或漏液，進而引起火災、人員受傷或周邊環境的髒污。</p>
	<p>如果長期不使用遙控器，應將電池取出。</p> <p>漏液可能導致火災、人員受傷或周邊環境的髒污。如果發生了漏液，請將流到電池盒的液體完全擦除，並放入新的電池。萬一漏出的液體接觸到身體，請用水將其沖洗乾淨。</p>
	<p>切勿將非指定的電池用於遙控器。</p> <p>破裂或漏液可能引起火災、人員受傷或周邊環境的髒污。</p>
	<p>切勿將電池與金屬製的小物品一起攜帶或保管。</p> <p>否則可能因短路而導致漏液或破裂。</p>
	<p>切勿拆解電池。</p> <p>電池內的酸性物質可能損傷皮膚和衣服。</p>

# 光碟

## 本機可播放的光碟

標示有“COMPACT disk DIGITAL AUDIO”的 CD



以音樂CD格式正確刻錄且已封盤的CD-R及CD-RW。

刻錄了MP3/WMA文件且已封盤的CD-R及CD-RW。

本機可以播放以上光碟。無法播放上述以外的光碟。

### ⚠ 注意

如果播放上述以外的光碟，可能產生巨大的噪音而損傷聽覺，亦可能損壞喇叭。切勿播放上述以外的光碟。

- 防拷貝CD，雙層光碟等不依據CD標準規格的特殊光碟可能無法正常播放。本機不保證使用特殊光碟時的功能及音質。如果特殊光碟難以播放，請諮詢該光碟的銷售商。

## CD-R/CD-RW

本機可以播放音樂CD格式（CD-DA）及以MP3/WMA 格式刻錄的CD-R/CD-RW。

- 用CD刻錄機製作的光碟，請勿忘記進行封盤。
- 由於光碟品質或錄音狀態的不同，某些光碟可能無法播放。詳情請閱讀手邊的產品說明書。
- 關於CD-R或CD-RW光碟的操作，如有不明之處，請直接諮詢光碟的銷售商。

## 使用注意事項

- 有裂紋的光碟可能導致播放器故障，因此請勿使用。
- 光碟勿貼標籤。留有透明膠或租賃CD標籤痕跡的光碟以及標籤滲出糊狀物的光碟不可使用。如果將這種狀態的光碟放入播放器，可能導致故障。
- 需在光碟標籤面上書寫時，請使用油性的記號筆。如果使用圓珠筆等前端堅固的筆，可能損傷光碟表面，導致無法錄音/播放。
- 切勿使用市面銷售的CD穩定器。否則可能導致無法播放及產生故障。
- 心形或八角形等特殊形狀的CD可能導致播放器故障，因此請勿使用。

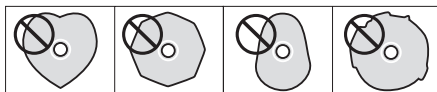

## 光碟的操作

- 請務必使光碟的標籤面（印刷面）朝上。
- 如果信號錄音面（無標籤面）存在劃痕、指紋或污垢等物，播放時可能出現錯誤，因此請小心操作。
- 從盒中取出光碟時，請按住盒子的中心，再用手夾住光碟的外沿並拿起。



取出方法



拿起方法

## MP3/WMA

本機可以播放CD-R/CD-RW上刻錄的MP3/WMA文件。

- 可播放音頻文件格式

MP3 ( “.mp3” )

位元速率 32kbps ~ 320kbps

取樣頻率 16kHz ~ 48kHz

WMA ( “.wma” )

位元速率 48kbps ~ 192kbps

取樣頻率 32、44.1、48kHz

※ 不對應DRM ( 數字版權管理 ) 。

### 使用電腦製作MP3/WMA文件時的注意事項

- 請務必為文件格式。無法識別無設定格式的文件。
- 刻錄到CD-R/CD-RW後，請進行封盤 ( 完成光碟的製作 )。無法播放未封盤的光碟。
- 本機最多可對應999首歌曲，99個文件夾。如果刻錄數量超過最大限度，將無法正確播放。

### 光碟的保管

- 使用後的光碟請務必放入盒內保管。隨手放置光碟將導致彎曲或刮花。
- 請勿將光碟放置在陽光直射、高溫多濕的場所。否則可能導致光碟變形、變質及無法播放。
- CD-R/CD-RW與一般的CD相比更易受到熱量及紫外線的影響，因此，請勿長時間放置在直射陽光下或發熱器具附近。
- 光碟的污垢可能導致音樂間斷或音質降低，因此保管光碟時應保持清潔。

### 保養

- 如果信號錄音面帶有指紋或灰塵，請使用軟布從內側中心向外側呈直角方向輕輕擦拭。



- 切勿使用唱片清潔劑、防靜電劑、稀釋劑等進行擦拭。這些化學藥品可能侵蝕光碟表面。

# 遙控器的使用方法

## 遙控器使用的注意事項

- 請將遙控器前端朝向主機的遙控傳感器，在5米範圍內進行操作。請勿在主機與遙控器之間放置障礙物。
- 如果直射陽光或照明強光照射遙控傳感器，遙控器可能會無法操作。
- 請注意，操作本機的遙控器可能使受紅外線控制的其他設備發生誤操作。

## 使用遙控器前

請從遙控器內取出絕緣片後再進行使用。



## 更換電池

出廠時遙控器裝有電池。

更換電池時，從遙控器內拉出電池托盤，如圖所示，將1個鈕扣型鋰電池（CR2025）的正極（+）朝上放入托盤。

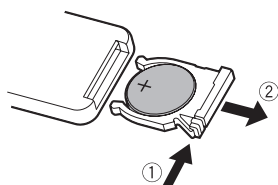

## 電池的更換時間

操作範圍變小，按操作鍵無效時，請更換新電池。用完的電池請按照電池記載的廢棄方法或按照各地政府指定的廢棄方法丟棄。

## ⚠ 警告

如果誤用電池，可能因電池破裂或漏液而導致火災、人員受傷或周邊環境的髒污。請熟讀第27頁的警告。

# 安裝方式

## 1 將壁掛板裝到牆上。

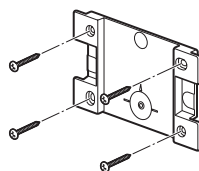

選擇牢固的牆壁，使用附帶的螺絲等物件安裝壁掛板。

- 請確認壁掛板沒有鬆動或浮起。

## ⚠ 注意

將壁掛板裝上牆時，請注意強度。

- 安裝到類似石膏板的建材或混凝土牆壁時，請使用市面銷售適合牆壁材質和結構的安裝螺絲。特別是使用木螺絲在石膏板上安裝時，螺絲容易脫落，非常危險。

## 2 伸展FM天線。

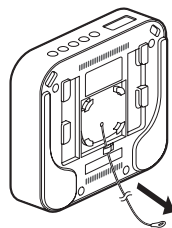

取下並伸展卷在背面的FM天線。

## 連接交流電源變壓器

電源線與交流電源變壓器相連後，請將電源插頭插入插座。

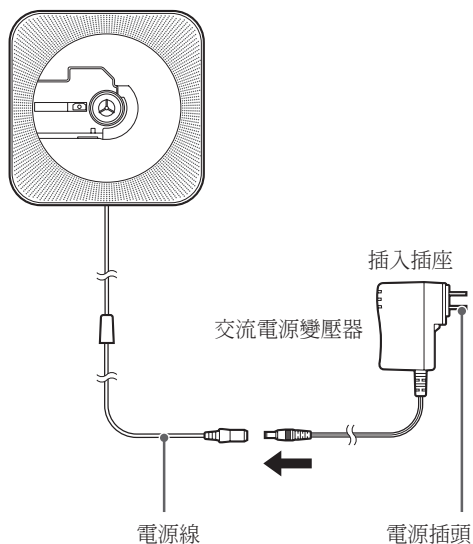

### 3 在壁掛板上安裝CD播放器。

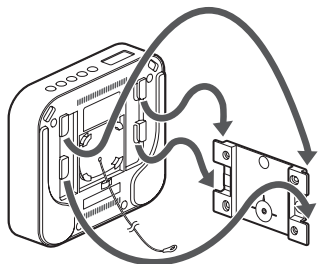

使壁掛板嵌入CD播放器背面的槽。

- 請確認安裝牢固。
- 請將FM天線伸展到信號接收最好的位置。

# 各部位名稱

## 主機

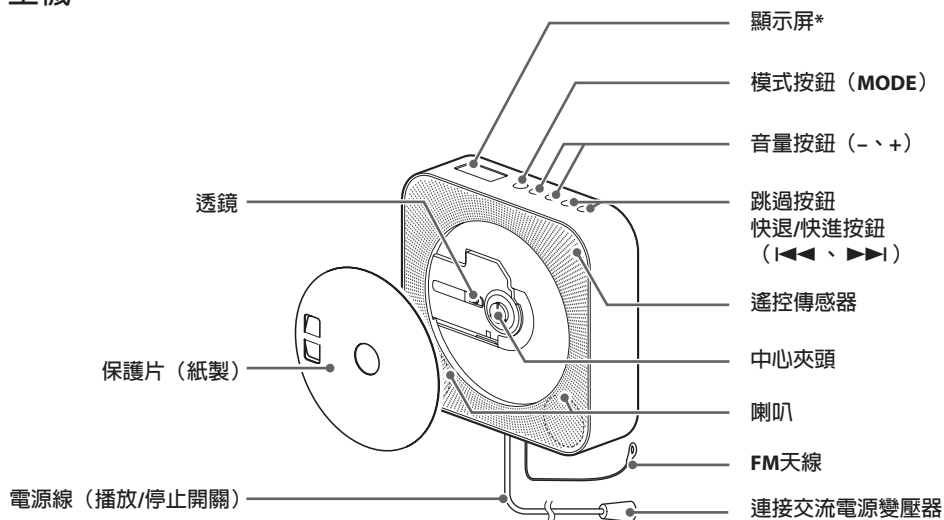

## 遙控器

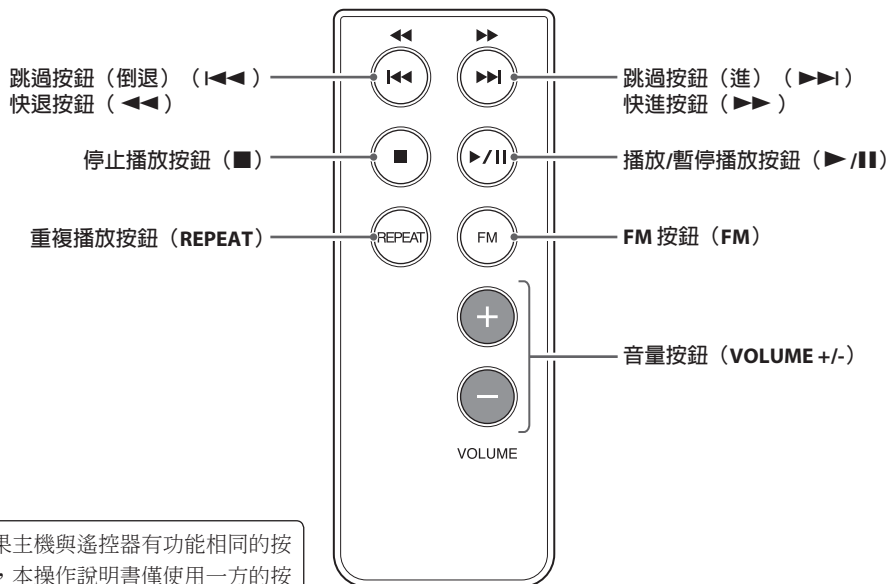

如果主機與遙控器有功能相同的按鈕，本操作說明書僅使用一方的按鈕進行說明，未記載的另一方按鈕功能相同。



# 聆聽CD

## 1 將CD放入主機。

將CD裝到主機的**中心夾頭**。

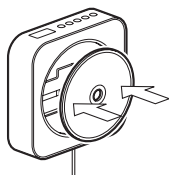

### ⚠ 警告

請裝好CD，直到發出“喀奇”的聲音。光碟播放時高速旋轉，如果沒裝好，可能導致CD錯位飛出，非常危險。

- 裝入CD時，請注意避免擦到主機，以免劃傷CD。

## 2 將電源線輕輕下拉，播放。

CD開始自動播放。

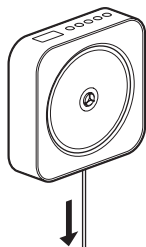

- 可使用遙控器的播放按鈕 (▶/||)。
- CD轉動時，請勿觸摸。

## 3 按音量按鈕 (-、+) 調節音量。

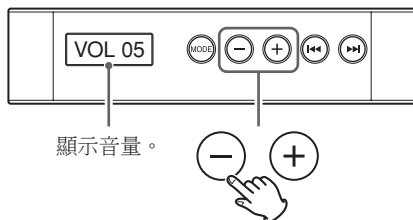

- 音量可調節範圍為00至32 (「MAX」)

如要停止播放，請再拉一次電源線。

- 可使用遙控器的停止按鈕 (■)。
- 若停止播放狀態超過30分鐘，機器會自動轉為待機狀態。欲解除待機狀態，請再次將電源線向下輕拉。

## 取下CD的方法

請將CD筆直向手前方拉，將其取下。



- 取下CD時，請注意避免擦到主機，以免劃傷CD。

### 注意

請勿觸摸透鏡。若有刮痕產生或髒污附著易導致故障，敬請留意。

# 聆聽CD (續)

## 選曲

### 退回前一曲

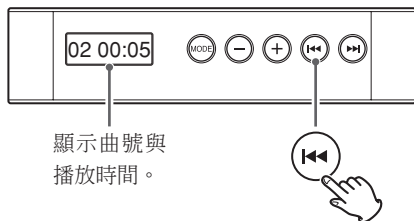

- 在播放過程中，如果反復按跳過按鈕 (⏮)，將退回前一曲。
- 在播放過程中，如果按 1 次跳過按鈕 (⏮)，將從正播放曲目的開始播放。
- 在播放過程中，如果按住跳過按鈕 (⏮)，將變為快退。

### 進到下一曲

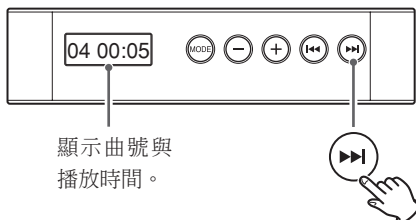

- 在播放過程中，如果反復按跳過按鈕 (⏭)，將進到下一曲。
- 在播放過程中，如果按 1 次跳過按鈕 (⏭)，將從下一曲的開始播放。
- 在播放過程中，如果按住跳過按鈕 (⏭)，將變為快進。

## 循環播放

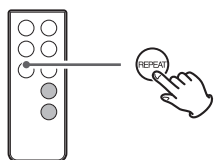

- 在播放過程中，按 1 次重複播放按鈕 (REPEAT)，將從第 1 曲到最後按順序循環播放 (顯示屏顯示“REPEAT”)。
- 如要停止循環播放，再按一次重複播放按鈕 (REPEAT) (顯示屏顯示“NORMAL”)。

## MP3/WMA文件的播放順序

在刻錄了MP3/WMA文件的CD內，與普通電腦文件的操作相同，可將MP3/WMA文件收入文件夾，也可以將多個文件夾匯總成1個文件夾。

### 使用本機播放MP3/WMA光碟時的文件夾編號與文件的播放順序 (1~7) 範例

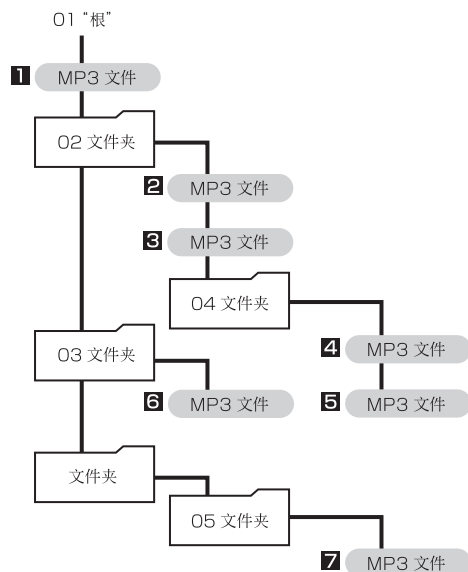

- 通過增加/刪除文件、文件夾或通過改變位置，可以改變上圖的順序。

# 收聽廣播

## 1 按模式按鈕 (MODE)。

音源變為FM。

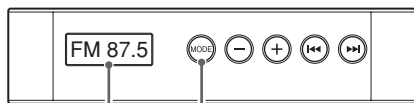

顯示“FM”後，  
顯示頻率。



- 也可以使用遙控器的FM按鈕 (FM)。
- 未裝有CD時，拉電源線也能執行同樣的操作。

## 2 選台。

自動選台

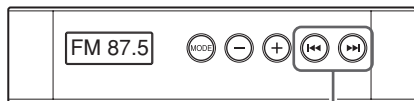

按住跳過按鈕 (I◀◀/▶▶I) 2秒以上，顯示屏顯示的頻率開始變化後，請鬆開手指。自動接收到電台信號，顯示屏停止顯示頻率。

- 如需在選台的途中停止，請輕按跳過按鈕 (I◀◀/▶▶I)。

## 手動選台

如想收到自動選台收不到的電台，請反復按跳過按鈕 (I◀◀/▶▶I)，選擇想聽的電台。

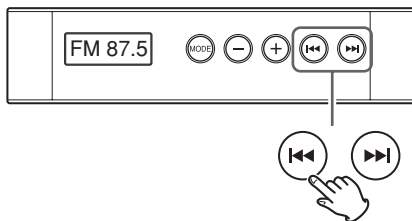

- 每輕按1次跳過按鈕 (I◀◀/▶▶I)，頻率將改變0.1MHz。
- 也能夠使用遙控器的跳過按鈕(I◀◀/▶▶I)操作。

## 3 按音量按鈕 (-、+) 調節音量。

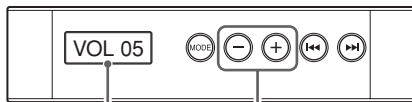

顯示音量。

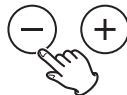

- 音量可調節範圍為00至32 (「MAX」)

## 信號狀態不佳時

信號狀態不佳時，請改變 FM 天線的朝向，搜尋信號最好的位置。

## 如需變為待機狀態，再按一次模式按鈕 (MODE)。

- 也可以使用遙控器的 FM 按鈕 (FM)。
- 未裝有CD時，拉電源線也能變為待機狀態。

# 處理故障

本機出現異常時，要求維修服務前，請再次檢查以下內容。

如果還是未能恢復正常，請聯繫您購買本產品的銷售商店。

## 一般

不運轉。

- ➔ 請將電源插頭插入插座。
- ➔ 請確認電源線與交流電源變壓器線相連。
- ➔ 請為遙控器更換新電池。

無法操作。

- ➔ 可能結露了。請等待約1小時後使用。

沒有聲音。

- ➔ 請調節音量。

無法用遙控器操作。

- ➔ 出廠時，電池部分帶有絕緣片。請取出絕緣片後使用。詳情參照第30頁。
- ➔ 如果電池電力不足，請更換新電池。
- ➔ 在離主機正面5米的範圍內朝向主機操作遙控器。
- ➔ 如果主機與遙控器之間有障礙物將無法操作，請調整位置。
- ➔ 主機附近如有強光燈，請關燈。

有雜音。

- ➔ 安裝播放器時，請盡可能遠離電視或微波爐等發出電磁波的物品。

## CD

CD無法放入主機。

- ➔ 請為主機中心夾頭清除灰塵或雜質。

無法播放。

- ➔ 裝入CD時請將標籤面朝上。
- ➔ 本機無法播放未封盤的CD-R/CD-RW。
- ➔ 因光碟種類不同，可能無法播放。詳情參照第28頁及第29頁。

聲音有間隔或中斷。

- ➔ 請安裝在振動小的場所。
- ➔ 請保持CD清潔。

## MP3/WMA文件

無法播放。

- ➔ 請確認文件的儲存格式。格式的詳情請參照第29頁。

## 廣播

無法接收。信號狀態不佳。

- ➔ 請選擇電台。
- ➔ 請嘗試改變主機的位置與朝向。
- ➔ 請嘗試改變FM天線的位置。

主機使用了微電腦，因此可能因外部雜音或噪音等原因而導致無法正常運轉。此時，請先從插座上拔下電源插頭，稍等片刻後再將電源插頭插入插座，然後重新操作。

## 保養

請使用微含中性清潔劑的軟布擦拭主機及遙控器的污垢。

請勿使用化學抹布、輕油精、稀釋劑等進行擦拭。否則可能損傷表面。

## 警告

為安全起見，請從插座上拔下電源插頭後進行保養。

# 規格

## CD播放器部分

使用的光碟	CD/CD-R/CD-RW (8cm/12cm)
可播放格式	CD-DA、MP3/WMA文件
讀取器	非接觸式讀取、半導體激光
取樣頻率	44.1kHz
頻率範圍	20Hz ~ 20kHz
抖晃率	低於檢測限定值

## 調諧器部分

信號接收頻率	87.5MHz ~ 108.0MHz
--------	--------------------

## 播放格式 (MP3/WMA)

MP3	
對應標準	MPEG-1/2 Audio Layer-3
格式	mp3
取樣頻率	16 ~ 48kHz
位元速率	32k ~ 320kbps
WMA	
對應標準	Windows Media Audio Standard (不對應DRM)
格式	wma
取樣頻率	32、44.1、48kHz
位元速率	48k ~ 192kbps
文件夾數量上限	.99
文件數量上限 (各文件夾)	.99

## 喇叭部分

喇叭單元	3.5cm 全音域型×2
額定阻抗	4Ω

## 擴大器部分

額定輸出功率 (EIAJ)	.2W×2
頻率範圍	50Hz ~ 20kHz

## 一般

電源電壓和電源頻率	AC 100 - 240V, 50 / 60Hz
額定消耗功率 (電氣安全額定值)	12W
最大外型尺寸 (主機部分)	寬 172mm 高 172mm 深 41mm
重量 (交流電源變壓器除外)	550g

## 附件

遙控器	×1
遙控器用鈕扣型鋰電池 (CR2025)	×1
(出廠時已裝入遙控器)	
壁掛板	×1
安裝螺絲	×4
專用交流電源變壓器	×1
操作說明書 (本書)	×1

規格及外觀可能因改良而變更，恕不另行通知。

操作說明書的部分插圖可能與商品不同。







MUJI TAIWAN Company Limited  
8F.,NO.8,Dongsing Rd.,Sinyi District.Taipei City 110,Taiwan  
[www.muji.tw](http://www.muji.tw)  
02-3765-5151

MUJI(Hong Kong)Company Limited  
1903-5 Miramar Tower, 132 Nathan Road, Tsim Sha Tsui, Kowloon, Hong Kong  
[www.muji.com.hk](http://www.muji.com.hk)  
+852 2694-9309

MUJI THAILAND

MUJI PHILIPPINE  
63-2-898-0246

MUJI INDONESIA  
<http://muji.co.id/>  
62-21-39830165

Muji (Singapore) Pte Ltd  
60 Albert Street #15-02to04, OG Albert Complex, Singapore 189969  
[www.muji.com.sg](http://www.muji.com.sg)